

Hercules System/370, ESA/390, z/Architecture Emulator

Hercules – User Reference Guide

Version 3 Release 07

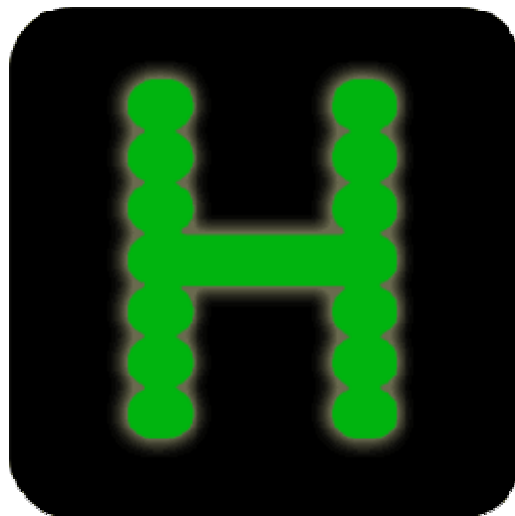

Contents

Contents	2
Figures.....	9
Tables.....	15
1. Preface	16
1.1 Edition information	16
1.2 What this book is about.....	16
1.3 Who should read this book	16
1.4 What you need to know to understand this book.....	16
1.5 How to use this book.....	16
1.6 Revision Notice	16
1.7 Readers Comments	17
1.8 Legal Advice.....	17
1.9 Trademarks	17
1.10 Acknowledgements	18
2. Related Publications	19
2.1 Hercules Emulator – General Information	19
2.2 Hercules Emulator – Installation Guide	19
2.3 Hercules Emulator – User Reference Guide	19
2.4 Hercules Emulator – Messages and Codes	19
2.5 Hercules Emulator – Reference Summary	19
3. Hercules Configuration File.....	20
3.1 The Configuration File.....	20
3.2 System Parameters.....	20
3.3 Device Definitions	22
3.4 Coding Rules.....	23
3.5 Record Format	24
3.6 Sample Configuration File.....	25
3.7 Symbol Substitution	27
3.8 Enhanced Symbol Substitution	29
4. System Parameter Descriptions.....	31
4.1 # or * (Comment lines)	31
4.2 ARCHMODE (Initial architecture mode)	32
4.3 ASN_AND_LX_REUSE / ALRF (ESAME ASN and LX REUSE feature)	33
4.4 AUTOMOUNT (Tape automount root directory)	34
4.5 AUTO_SCSI_MOUNT (Automatic SCSI tape mounts).....	36
4.6 CCKD (Compressed CKD DASD options).....	37
4.7 CNSLPORT (Telnet client port)	42
4.8 CODEPAGE (Codepage conversion table)	43
4.9 CONKPALV (Console and telnet clients keep-alive option)	45
4.10 CPUMODEL (CPU model)	47
4.11 CPUPRIO (CPU thread process priority)	48
4.12 CPUSERIAL (CPU serial number)	49
4.13 CPUVERID (CPU version code)	50
4.14 DEFSYM (Define symbol)	51

4.15	DEVPRIO (Device threads process priority)	52
4.16	DEVTMAX (Maximum number of device threads)	53
4.17	DIAG8CMD (DIAGNOSE 8 command setting)	55
4.18	ECPSVM (ECPS:VM support status (VM))	57
4.19	ENGINES (Processor engine type)	59
4.20	HERCLOGO (Hercules 3270 logo)	61
4.21	HERCPRIO (Hercules process priority)	62
4.22	HTTPPORT (HTTP server port)	63
4.23	HTTPROOT (HTTP server root directory)	65
4.24	IGNORE (Ignore subsequent INCLUDE errors)	66
4.25	INCLUDE (Include configuration file)	67
4.26	IODELAY (I/O interrupt wait time (LINUX))	68
4.27	LDMOD (Additional dynamic load modules)	69
4.28	LEGACYSenseID (SENSE ID CCW (x'E4') feature)	70
4.29	LOADPARM (IPL parameter)	71
4.30	LOGOPT (Log options)	72
4.31	LPARNAME (LPAR name returned by DIAG x'204')	73
4.32	LPARNUM (LPAR identification number)	74
4.33	MAINSIZE (Main storage in MB)	75
4.34	MANUFACTURER (Manufacturer name returned by STSI instruction)	76
4.35	MAXCPU (Maximum number of CPUs)	77
4.36	MODEL (Model names returned by STSI instruction)	78
4.37	MODPATH (Dynamic load module path)	80
4.38	MOUNTED_TAPE_REINIT (Control tape initialization)	81
4.39	NUMCPU (Number of emulated CPUs)	82
4.40	NUMVEC (Number of vector facilities)	83
4.41	OSTAILOR (Intended operating system)	84
4.42	PANRATE (Panel refresh rate)	86
4.43	PANTITLE (Hercules console window title)	87
4.44	PGMPRDOS (LPP license setting)	88
4.45	PLANT (Plant name returned by STSI instruction)	89
4.46	SCLPROOT (SCLP base directory)	90
4.47	SHCMDOPT (Shell command option)	91
4.48	SHRDPOR (Shared device server port)	92
4.49	SYSEPOCH (Base date for TOD clock)	93
4.50	TIMERINT (Internal timer update interval)	94
4.51	TODDRAG (TOD clock drag factor)	95
4.52	TODPRIO (Timer thread process priority)	96
4.53	TRACEOPT (Instruction trace display option)	97
4.54	TZOFFSET (TOD clock offset from GMT)	98
4.55	XPNDSIZE (Expanded storage in MB)	99
4.56	YROFFSET (TOD clock offset from actual date)	100
4.57	Process and Thread Priorities	101
5.	Device Definition Descriptions	103
5.1	Local non-SNA 3270 Devices	103
5.2	Integrated 3270 (SYSG) Console	106

5.3	Console Printer-Keyboard Devices.....	109
5.4	Integrated Console Printer-Keyboard Devices	112
5.5	Card Reader Devices.....	113
5.6	Card Punch Devices	115
5.7	Line Printer Devices.....	117
5.8	Emulated Tape Devices.....	120
5.9	Channel-to-Channel Adapters	134
5.10	FBA DASD Devices.....	141
5.11	CKD DASD Devices	143
5.12	Communication Lines (Preliminary 2703 BSC Support)	147
6.	Hercules Console.....	150
6.1	Hercules Hardware Console	150
6.2	Web browser interface	152
6.3	Using the keyboard	153
6.4	Log formats	155
6.5	Hercules Console Commands (sorted alphabetically).....	158
6.6	Hercules Console Commands (grouped by functionality).....	163
7.	Console Command Descriptions.....	169
7.1	!message (SCP priority message)	169
7.2	# or * (Log comment to syslog).....	170
7.3	.reply (SCP command).....	171
7.4	? (List all commands / command specific help)	172
7.5	AEA (Display AEA tables).....	174
7.6	AIA (List AIA fields)	175
7.7	AR (Display access registers).....	176
7.8	ARCHMODE (Set architecture mode)	177
7.9	ATTACH (Configure device)	179
7.10	AUTOMOUNT (Show or update allowable tape automount directories).....	181
7.11	AUTO_SCSI_MOUNT (Automatic SCSI tape mounts)	183
7.12	B (Set breakpoint).....	185
7.13	B+ (Set breakpoint)	186
7.14	B- (Delete breakpoint)	187
7.15	CACHE (Cache command)	188
7.16	CCKD (CCKD command).....	190
7.17	CD (Change directory)	196
7.18	CF (Configure CPU online or offline).....	197
7.19	CFALL (Configure all CPUs online or offline).....	199
7.20	CLOCKS (Display TOD clock and CPU timer).....	201
7.21	CMDTGT (Specify the command target).....	202
7.22	CONKPALV (Display / alter console TCP/IP keep-alive settings)	204
7.23	CPU (Define target CPU for console displays and commands).....	206
7.24	CR (Display or alter control registers)	207
7.25	CSCRIPT (Cancel a running script thread)	209
7.26	CTC (Enable / disable debug packet tracing)	210
7.27	DEFINE (Rename device).....	213
7.28	DEFSYM (Define symbol)	214

7.29	DETACH (Remove device)	216
7.30	DEVINIT (Reinitialize device)	217
7.31	DEVLIST (List device or all devices)	219
7.32	DEVTMAX (Display or set maximum device threads).....	221
7.33	DS (Display subchannel).....	223
7.34	ECPSVM (ECPS:VM commands)	226
7.35	EXIT (Terminate the emulator).....	229
7.36	EXT (Generate external interrupt).....	231
7.37	F{+/-} (Mark frames usable or unusable).....	232
7.38	FPC (Display floating point control register).....	234
7.39	FPR (Display floating point registers).....	235
7.40	G (Turn off instruction stepping and start CPU)	237
7.41	GPR (Display or alter general purpose registers)	238
7.42	HAO (Hercules Automatic Operator).....	240
7.43	HELP (List all commands / command specific help)	243
7.44	HERC (Send Hercules command)	245
7.45	HERCLOGO (Read new logo file).....	246
7.46	HST (History of commands)	247
7.47	I (Generate I/O attention interrupt for device)	249
7.48	IODELAY (Display or set I/O delay value)	250
7.49	IPENDING (Display pending interrupts).....	252
7.50	IPL (IPL normal from device xxxx)	254
7.51	IPLC (IPL clear from device xxxx)	256
7.52	K (Display CCKD internal trace).....	258
7.53	LDMOD (Load a module)	260
7.54	LOADCORE (Load a core image file)	261
7.55	LOADPARAM (Set IPL parameter).....	262
7.56	LOADTEXT (Load a text deck file).....	264
7.57	LOG (Direct log output)	265
7.58	LOGOPT (Change log options)	266
7.59	LPARNAME (Display or set LPAR name).....	267
7.60	LPARNUM (Display or set LPAR identification number).....	269
7.61	LSDEP (List module dependencies)	271
7.62	LSMOD (List dynamic modules).....	272
7.63	MAXRATES (Display maximum observed MIPS/SIO rate or define new reporting interval)..	274
7.64	MESSAGE (Display message on console like VM)	276
7.65	MOUNTED_TAPE_REINIT (Control tape initialization)	277
7.66	MSG (Display message on console like VM)	279
7.67	MSGHLD (Display or set timeout of held messages).....	280
7.68	MSGNOH (Display message on console like VM, but without header)	282
7.69	OSTAILOR (Specify intended operating system).....	283
7.70	PANRATE (Display or set console refresh rate)	285
7.71	PGMTRACE (Trace program interrupts).....	287
7.72	PR (Display prefix register)	289
7.73	PSCP (Send system control program priority message).....	290
7.74	PSW (Display or alter program status word).....	291

7.75	PTT (Set / display pthread trace)	294
7.76	PWD (Print working directory)	298
7.77	QD (Query DASD)	299
7.78	QUIET (Toggle automatic refresh of console display data)	302
7.79	QUIT (Terminate the emulator)	303
7.80	R (Display or alter real storage)	305
7.81	RESTART (Generate restart interrupt).....	307
7.82	RESUME (Resume Hercules).....	308
7.83	RMMOD (Delete a module).....	310
7.84	S (Instruction stepping)	311
7.85	S+ (Instruction stepping on)	313
7.86	S- (Instruction stepping off)	315
7.87	S? (Instruction stepping query)	316
7.88	S{+/-} dev (Turn CCW stepping on or off)	317
7.89	SAVECORE (Save a core image to a file)	320
7.90	SCLPROOT (Set or display SCLP base directory)	322
7.91	SCP (Send system control program command).....	324
7.92	SCRIPT (Run a sequence of commands contained in a file).....	325
7.93	SCSIMOUNT (Automatic SCSI tape mounts)	326
7.94	SF+ (Create a new shadow file).....	328
7.95	SF- (Remove a shadow file).....	329
7.96	SFC (Compress a shadow file)	331
7.97	SFD (Display shadow file statistics)	332
7.98	SFK (Perform a chkdsk on the active shadow file)	333
7.99	SH (Shell command)	336
7.100	SHRD (SHRD command).....	338
7.101	SIZEOF (Display size of structures).....	340
7.102	SSD (Signal shutdown)	341
7.103	START (Start CPU or printer device)	342
7.104	STARTALL (Start all CPUs)	343
7.105	STOP (Stop CPU or printer device)	344
7.106	STOPALL (Stop all CPUs)	345
7.107	STORE (Store CPU status at absolute zero)	346
7.108	SUSPEND (Suspend Hercules)	347
7.109	SYNCIO (Display SYNCIO device statistics)	349
7.110	SYSCLEAR (Issue SYSTEM CLEAR RESET manual operation)	350
7.111	SYSRESET (Issue SYSTEM RESET manual operation)	351
7.112	T (Instruction trace)	352
7.113	T+ (Instruction trace on)	353
7.114	T- (Instruction trace off)	355
7.115	T? (Instruction trace query)	356
7.116	T{+/-} CKD (Turn CKD_KEY tracing on or off)	357
7.117	T{+/-} dev (Turn CCW tracing on or off)	359
7.118	TIMERINT (Display or set timers update interval).....	362
7.119	TLB (Display TLB tables)	364
7.120	TODDRAG (Display or set TOD clock drag factor)	365

7.121	TRACEOPT (Instruction trace display options)	367
7.122	TT32 (Control / query CTCI-W32 functionality)	369
7.123	U (Disassemble storage)	371
7.124	UPTIME (Display Hercules Emulator uptime)	373
7.125	V (Display or alter virtual storage)	374
7.126	VERSION (Display version information)	377
8.	Hercules Utilities	378
8.1	Overview	378
8.2	CCKDCDSK (CCKD DASD file integrity verification, recovery and repair utility)	381
8.3	CCKDCOMP (CCKD DASD file compression utility)	383
8.4	CCKDDIAG (CCKD DASD file diagnostics utility)	385
8.5	CCKDSWAP (CCKD DASD file swap-endian program)	388
8.6	CKD2CCKD (Copy CKD DASD file to CCKD DASD file)	389
8.7	CCKD2CKD (Copy CCKD DASD file to CKD DASD file)	390
8.8	DASDCAT (Display PDS datasets and members)	391
8.9	DASDCONV (DASD image file conversion program)	395
8.10	DASDCOPY (Copy DASD file to another DASD file)	397
8.11	DASDINIT (DASD image file creation)	399
8.12	DASDISUP (Fix XCTL tables in SVCLIB)	402
8.13	DASDLOAD (DASD loader program)	404
8.14	DASDLS (List datasets on a volume)	412
8.15	DASDPDSU (PDS unload utility)	414
8.16	DASDSEQ (Display sequential datasets)	416
8.17	HETGET (Extract files from an AWS or HET tape file)	418
8.18	HETINIT (Initialize an AWS or HET tape file)	420
8.19	HETMAP (Show information about a HET or AWS tape file)	422
8.20	HETUPD (Update and/or copy an AWS or HET tape file)	427
8.21	TAPECOPY (Copy a SCSI tape to or from an AWSTAPE disk file)	429
8.22	TAPEMAP (Show information about an AWS tape file)	431
8.23	TAPESPLT (Split an AWS tape file)	433
8.24	DMAP2HRC (P/390 DEVMAP conversion program)	435
8.25	PRT PUB (Mainframe print publishing program)	436
8.26	AWSSL (AWS virtual tape)	440
8.27	AWSUTIL (AWS format tape file generation utility)	445
8.28	RAWSTAPE (Reverse AWSTAPE utility)	447
8.29	VTTS (Virtual tape transportation system)	448
9.	Shared Device Support	451
9.1	Basics	451
9.2	Caching	451
9.3	Compression	451
9.4	Usage of Shared Devices	452
10.	Hercules 3270 Logo	454
10.1	Function	454
10.2	Orders	454
10.3	Variables	456
10.4	Sample	456

11.	Starting the Hercules Emulator.....	459
11.1	Starting Hercules in Native Mode.....	459
11.2	Starting Hercules with the Windows GUI	460
11.3	Starting Hercules with the Hercules Studio.....	461
11.4	The hercules.rc (run-commands) file.....	462
12.	Submitting Jobs via the Socket Reader	463
12.1	Socket Reader Basics	463
12.2	Submitting Jobs from Windows.....	464
12.3	Submitting Jobs from Unix	465
	Appendix A: Supported DASD Device Types.....	467
	Appendix B. Syntax	470
	B.1 Reading Syntax Descriptions	470
	B.2 Reading Syntax Diagrams.....	471
	Appendix C. Links.....	474

Figures

Figure 1: Sample Configuration File.....	27
Figure 2: OAT File Syntax	139
Figure 3: Hercules Hardware Console	151
Figure 4: Hercules device and status panel	152
Figure 5: Hercules web browser interface.....	153
Figure 6: Message prefixing using the native Hercules console	156
Figure 7: WinGUI Advanced Logging Options	157
Figure 8: Message prefixing using the console of the Hercules WinGUI.....	157
Figure 9: Log comment command.....	170
Figure 10: SCP command	171
Figure 11: “?” command	173
Figure 12: AEA command	174
Figure 13: AIA command.....	175
Figure 14: AR command.....	176
Figure 15: ARCHMODE command (display architecture mode).....	177
Figure 16: ARCHMODE command (set architecture mode)	178
Figure 17: ATTACH command (configure printer)	179
Figure 18: ATTACH command (configure display terminal).....	180
Figure 19: AUTOMOUNT command (add entry).....	182
Figure 20: AUTOMOUNT command (list entries).....	182
Figure 21: AUTOMOUNT command (delete entry).....	182
Figure 22: AUTO_SCSI_MOUNT command (display settings).....	184
Figure 23: AUTO_SCSI_MOUNT command (set value).....	184
Figure 24: B command	185
Figure 25: B+ command	186
Figure 26: B- command.....	187
Figure 27: CACHE command.....	189
Figure 28: CCKD HELP command.....	195
Figure 29: CCKD OPTS command	195
Figure 30: CCKD STATS command.....	195
Figure 31: CCKD command (set options)	195
Figure 32: CD command (absolute path)	196
Figure 33: CD command (relative path)	196
Figure 34: CF command (display CPU status).....	197
Figure 35: CF command (configure CPU offline)	198
Figure 36: CF command (configure CPU online)	198
Figure 37: CFALL command (display status of all CPUs).....	199
Figure 38: CFALL command (configure all CPUs offline)	200
Figure 39: CFALL command (configure all CPUs online)	200
Figure 40: CLOCKS command.....	201
Figure 41: CMDTGT command (display current setting)	202
Figure 42: CMDTGT command (set target to SCP)	203
Figure 43: CMDTGT command (set target back to Hercules).....	203
Figure 44: CONKPALV command.....	205

Figure 45: CPU command.....	206
Figure 46: CR command (display control registers).....	207
Figure 47: CR command (alter control register).....	208
Figure 48: CSCRIPT command.....	209
Figure 49: CTC command.....	212
Figure 50: DEFINE command.....	213
Figure 51: DEFSYM command (list all symbols).....	214
Figure 52: DEFSYM command (define new symbol).....	215
Figure 53: DEFSYM command (clear defined symbol).....	215
Figure 54: DETACH command.....	216
Figure 55: DEVINIT command.....	218
Figure 56: DEVLIST command.....	220
Figure 57: DEVTMAX command (list maximum device threads).....	222
Figure 58: DEVTMAX command (set maximum device threads).....	222
Figure 59: DS command.....	223
Figure 60: Subchannel-Information Block.....	224
Figure 61: Path-Management-Control Word.....	224
Figure 62: Subchannel-Status Word.....	225
Figure 63: ECPSVM STATS command.....	227
Figure 64: ECPSVM ENABLE command.....	228
Figure 65: ECPSVM LEVEL command.....	228
Figure 66: EXIT command.....	230
Figure 67: EXT command.....	231
Figure 68: F- command.....	232
Figure 69: F+ command.....	233
Figure 70: FPC command.....	234
Figure 71: FPR command (basic format).....	235
Figure 72: FPR command (extended format).....	236
Figure 73: G command.....	237
Figure 74: GPR command (display general purpose registers).....	238
Figure 75: GPR command (alter general purpose register).....	239
Figure 76: HAO command (tgt).....	241
Figure 77: HAO command (cmd).....	241
Figure 78: HAO command (list).....	241
Figure 79: HAO command (del).....	242
Figure 80: HAO command (clear).....	242
Figure 81: HAO fired command.....	242
Figure 82: HELP command (information available).....	243
Figure 83: HELP command (no information available).....	244
Figure 84: HERC command.....	245
Figure 85: HERCLOGO command.....	246
Figure 86: HST command.....	248
Figure 87: I command.....	249
Figure 88: IODELAY command (display value).....	250
Figure 89: IODELAY command (set value).....	251
Figure 90: IPENDING command.....	253

Figure 91: IPL command	255
Figure 92: IPLC command.....	257
Figure 93: K command	259
Figure 94: LDMOD command.....	260
Figure 95: LOADCORE command	261
Figure 96: LOADPARM command (display IPL parameter).....	262
Figure 97: LOADPARM command (set IPL parameter)	263
Figure 98: LOG command.....	265
Figure 99: LOGOPT command	266
Figure 100: LPARNAME command (display LPAR name)	267
Figure 101: LPARNAME command (define LPAR name).....	268
Figure 102: LPARNUM command (set LPARNUM).....	269
Figure 103: LPARNUM command (display LPARNUM)	270
Figure 104: LSDEP command.....	271
Figure 105: LSMOD command.....	273
Figure 106: MAXRATES command (set the interval time).....	274
Figure 107: MAXRATES command (display maximum rates)	275
Figure 108: MESSAGE command.....	276
Figure 109: MOUNTED_TAPE_REINIT command (display settings).....	278
Figure 110: MOUNTED_TAPE_REINIT command (disallow tape mount reinitialization).....	278
Figure 111: MSG command	279
Figure 112: MSGHELD command (set new interval)	280
Figure 113: MSGHELD command (release messages).....	281
Figure 114: MSGNOH command	282
Figure 115: OSTAILOR command (display intended operating system)	284
Figure 116: OSTAILOR command (specify intended operating system)	284
Figure 117: PANRATE command (list current value).....	285
Figure 118: PANRATE command (set new value).....	286
Figure 119: PGMTRACE command (display settings).....	287
Figure 120: PGMTRACE command (change settings)	288
Figure 121: PR command.....	289
Figure 122: PSW command (display PSW)	292
Figure 123: PSW command (modify PSW).....	293
Figure 124: PSW command (modify PSW).....	293
Figure 125: PTT command (display trace options / set options and start trace).....	296
Figure 126: PTT command (display trace entries)	297
Figure 127: PTT command (start trace and issue automatic display).....	297
Figure 128: PWD command	298
Figure 129: QD command	300
Figure 130: QUIET command.....	302
Figure 131: QUIT command	304
Figure 132: R command (display real storage)	306
Figure 133: R command (alter real storage)	306
Figure 134: RESTART command.....	307
Figure 135: RESUME command	309
Figure 136: RMMOD command	310

Figure 137: S command	312
Figure 138: S+ command	314
Figure 139: S- command	315
Figure 140: S? command	316
Figure 141: S+ dev command	318
Figure 142: S- dev command	319
Figure 143: SAVECORE command (save specific area)	321
Figure 144: SAVECORE command (save from begin to end)	321
Figure 145: SCLPROOT command (display directory)	322
Figure 146: SCLPROOT command (set directory)	323
Figure 147: SCP command	324
Figure 148: SCRIPT command	325
Figure 149: SCSIMOUNT command	327
Figure 150: SF+ command	328
Figure 151: SF- command	330
Figure 152: SF- NOMERGE command	330
Figure 153: SFC command	331
Figure 154: SFD command	332
Figure 155: SFK command (chkdsk level 2)	334
Figure 156: SFK command (chkdsk level 4)	335
Figure 157: SH command	337
Figure 158: SHRD command (initialize trace table)	338
Figure 159: SHRD command (print trace table)	339
Figure 160: SIZEOF command	340
Figure 161: SSD command	341
Figure 162: START command (start printer)	342
Figure 163: START command (start CPU)	342
Figure 164: STARTALL command	343
Figure 165: STOP command (stop printer)	344
Figure 166: STOP command (stop CPU)	344
Figure 167: STOPALL command	345
Figure 168: STORE command	346
Figure 169: SUSPEND command	348
Figure 170: SYNCIO command	349
Figure 171: SYSCLEAR command	350
Figure 172: SYSRESET command	351
Figure 173: T command	352
Figure 174: T+ command	354
Figure 175: T- command	355
Figure 176: T? command	356
Figure 177: T+CKD command	358
Figure 178: T-CKD command	358
Figure 179: T+ dev command	360
Figure 180: T- dev command	361
Figure 181: T+ dev command (several devices)	361
Figure 182: TIMERINT command (list current value)	362

Figure 183: TIMERINT command (set new value).....	363
Figure 184: TLB command.....	364
Figure 185: TODDRAG command (display TOD clock factor).....	365
Figure 186: TODDRAG command (set TOD clock factor).....	366
Figure 187: TRACEOPT command (TRADITIONAL).....	368
Figure 188: TRACEOPT command (REGSFIRST).....	368
Figure 189: TRACEOPT command (NOREGS).....	368
Figure 190: TT32 DEBUG command.....	369
Figure 191: TT32 NODEBUG command.....	370
Figure 192: TT32 STATS command.....	370
Figure 193: U command.....	372
Figure 194: UPTIME command (uptime < 1 day).....	373
Figure 195: UPTIME command (uptime > 1 week).....	373
Figure 196: V command (display virtual storage with length).....	375
Figure 197: V command (alter virtual storage).....	375
Figure 198: V command (display virtual storage with range).....	376
Figure 199: V command (display virtual storage with 'S' option).....	376
Figure 200: VERSION command.....	377
Figure 201: CCKDCDSK utility output.....	382
Figure 202: CCKDCOMP utility output.....	384
Figure 203: CCKDDIAG utility output.....	387
Figure 204: CCKDSWAP utility output.....	388
Figure 205: DASDCAT utility output (create PDS member list).....	392
Figure 206: DASDCAT utility output (list a member from a PDS).....	393
Figure 207: DASDCAT utility output (list all members of a PDS).....	394
Figure 208: DASDCONV utility output.....	396
Figure 209: DASDCOPY utility output.....	398
Figure 210: DASDINIT utility output.....	401
Figure 211: DASDISUP utility output.....	403
Figure 212: DASDLOAD utility output (XMIT method, message level 1).....	408
Figure 213: DASDLOAD utility output (XMIT method, message level 3).....	409
Figure 214: DASDLOAD utility output (SEQ method, message level 5).....	411
Figure 215: DASDLS utility output.....	413
Figure 216: DASDPDSU utility output.....	415
Figure 217: DASDSEQ utility output.....	417
Figure 218: HETGET utility output.....	419
Figure 219: HETINIT utility output.....	421
Figure 220: HETMAP utility output (print all label and file information).....	425
Figure 221: HETMAP utility output (print only dataset information).....	425
Figure 222: HETMAP utility output (TAPEMAP compatible output).....	426
Figure 223: HETUPD utility output.....	428
Figure 224: TAPECOPY utility output.....	430
Figure 225: TAPEMAP utility output (map AWS tape file).....	432
Figure 226: TAPESPLT utility output.....	434
Figure 227: AWSSL JCL (Create AWS virtual tape).....	443
Figure 228: AWSSL JCL (Create datasets from AWS virtual tape).....	444

Figure 229: AWSUTIL utility JCL.....	446
Figure 230: RAWSTAPE utility JCL	447
Figure 231: IEBGENER JCL for RAWSTAPE utility	447
Figure 232: VTT2DISK utility JCL.	449
Figure 233: VTT2TAPE utility JCL	450
Figure 234: VTT2CNVU utility JCL.....	450
Figure 235: Logo File.....	457
Figure 236: Logo Screen	458
Figure 237: HercRdr Help Screen	464
Figure 238: SUBmit REXX for SPF/PC	465
Figure 239: The Hercsub Perl Script	466

Tables

Table 1: Hercules System Parameters.....	22
Table 2: Hercules Device Definitions	23
Table 3: Supported codepage mappings	44
Table 4: Process Priority Conversions	101
Table 5: Thread Priority Conversions.....	102
Table 6: Default CU Types	145
Table 7: Normal cursor handling	154
Table 8: Extended cursor handling.....	155
Table 9: Message prefix overview	155
Table 10: Hercules Console Commands (sorted alphabetically)	162
Table 11: Hercules Console Commands (grouped by functionality)	168
Table 12: Sense ID.....	300
Table 13: Read Device Characteristics	301
Table 14: Read Configuration Data.....	301
Table 15: DASD image file maintenance utilites	378
Table 16: TAPE file maintenance utilities.....	379
Table 17: Miscellaneous utilities.....	379
Table 18: Third party utilities	379
Table 19: Mainframe utilities.....	380
Table 20: Supported CKD DASD Devices	468
Table 21: Supported FBA DASD Devices	469
Table 22: Reading Syntax Descriptions	470
Table 23: Reading Syntax Diagrams.....	473

1. Preface

1.1 Edition information

This edition applies to the Hercules S/370, ESA/390 and z/Architecture Emulator, Release 3.07.0 and to all subsequent versions, releases and modifications until otherwise indicated in new editions. Make sure you are using the correct edition for the level of software you are using.

1.2 What this book is about

This book is a guide for using and operating the Hercules Emulator and related additional products (both required and optional). For guidance in installation or debugging Hercules or for a general overview, additional manuals are available.

Please note that some information can be found in more than one manual. This redundancy is not intended to unnecessarily expand the manuals, rather to help find all necessary information in one place.

1.3 Who should read this book

This book is mainly intended for people who are responsible for operating the Hercules Emulator. It may also be useful if you are responsible for installing the Hercules Emulator.

1.4 What you need to know to understand this book

To understand this book, you should be familiar using software under the Linux, Windows (XP, W2K, Vista) or Mac OS X operating systems. You should also have experience with Linux command shells or native DOS (Microsoft Disk Operating System) and the Microsoft Windows command shell.

Last but not least you should be familiar with IBM mainframe environments (hardware and software) and the underlying ideas and concepts as Hercules emulates IBM mainframe hardware.

1.5 How to use this book

This book is designed as a reference for all aspects the Hercules Emulator and related products. You can go through the book chapter by chapter or you can use the book as a reference for all questions regarding the operation of Hercules.

1.6 Revision Notice

Hercules Release:	Version 3 Release 07 Modification 0
Publication Number:	HEUR030700
SoftCopy Name:	HerculesUserReference
Revision Number:	HEUR030700-02
Date:	March 20, 2011

1.7 Readers Comments

If you like or dislike anything of this book please send a mail or email to the address below. Feel free to comment any errors or lack of clarity. Please limit your comments on the information in this specific book and also include the "Revision Notice" just above. Thank you for your help.

Send your comments by email to the Hercules-390 discussion group:

hercules-390@yahoogroups.com

1.8 Legal Advice

Hercules implements only the raw S/370, ESA/390, and z/Architecture instruction set, it does not provide any operating system facilities. This means that you need to provide an operating system or standalone program which Hercules can load from an emulated disk or tape device. You will have to write the operating system or standalone program yourself unless you possess a license from IBM to run one of their operating systems on your PC or use IBM programs and operating systems which have been placed in the public domain.

NOTE: It is YOUR responsibility to comply with the terms of the license for the operating system you intend to run on the Hercules Emulator.

1.9 Trademarks

The following is a list of trademark acknowledgments and copyright notices for product and company names mentioned in this book. Other product and company names in this book that are not listed below may be the trademarks or registered trademarks of their respective owners.

- IBM, System/370, ESA/390, z/Architecture, MVS, OS/390, z/OS, VM, VM/ESA, z/VM, VSE, VSE/ESA, z/VSE are trademarks or registered trademarks of International Business Machines Corporation (IBM).
- Windows 95, Windows 98, Windows ME, Windows NT, Windows 2000, Windows XP, Windows Vista, Windows 7, Windows Server 2000, Windows Server 2003, Windows Server 2008, Visual C++ Toolkit 2003, Visual C++ 2005 Express are trademarks of Microsoft Corporation.
- Linux is a trademark owned by Linus Torvalds. The Linux Mark Institute is the exclusive licensor of the Linux trademark on behalf of its owner Linus Torvalds.
- WinPcap is copyrighted by NetGroup, Politecnico di Torino (Italy).
- Cygwin is copyrighted by Red Hat, Inc.
- Vista tn3270 is copyrighted by Tom Brennan Software.
- Pentium, XEON are trademarks or registered trademarks of Intel Corporation.
- Athlon, Opteron are trademarks or registered trademarks of Advanced Micro Devices (AMD), Inc.
- Xmit Manager is copyrighted by Neal Johnston-Ward.
- FLEX-ES is a registered trademark of Fundamental Software, Inc.
- UMX Virtual Mainframe is a registered trademark of UMX Technologies.

1.10 Acknowledgements

The Hercules manuals would not have been possible without the assistance of many people and I would like to thank all those who helped me. In particular I would like to thank:

- The Hercules developers for their documentation on various websites from which I derived a great deal of information.
- Roger Bowler and Fish for proof-reading the manuals.
- Loris Degoianni for allowing me to use parts of the original WinPcap documentation.
- Tom Brennan for allowing me to use parts of his Vista tn3270 documentation.
- My colleagues for working with early previews of the documentation, beginning with just a few pages.
- Mike Cairns for reviewing and editing the manuals.

If anyone feels they have been forgotten on this list please let me know.

Peter Glanzmann

2. Related Publications

2.1 Hercules Emulator – General Information

The Hercules "General Information" manual provides you an overview of the ideas and concepts of the Hercules Emulator as well as a documentation of the emulator's functionality. It explains what Hercules does and does not do. It helps you decide if the software fits your needs fulfills your requirements.

2.2 Hercules Emulator – Installation Guide

The Hercules "Installation Guide" shows you how to install Hercules and all related optional and required software components under the Microsoft Windows, Linux and Apple Macintosh OS X operating systems.

After going through the installation guide you will have a working emulator environment ready to IPL a S370, S/390 or z/Architecture mainframe operating system.

2.3 Hercules Emulator – User Reference Guide

The Hercules "User Reference" leads you through all aspects of the emulator's operation. It provides instruction in the operation of the Hercules Emulator with and without the Windows GUI. The usage details for all Hercules utilities are also covered in this guide.

After reading this manual you should be able to work with Hercules and the Hercules console, create virtual devices, understand backup/restore procedures and general housekeeping within the Hercules environment.

2.4 Hercules Emulator – Messages and Codes

The "Messages and Codes" manual provides a detailed explanation of all Hercules related messages. It is the primary source for troubleshooting and debugging when experience problems with Hercules.

2.5 Hercules Emulator – Reference Summary

The Hercules "Reference Summary" booklet lists all the system parameters, device definitions, console commands, Hercules utilities etc. along with their arguments.

This booklet is intended as a quick reference guide for experienced users. Consult the Hercules "User Reference Guide" for more detailed and additional information.

3. Hercules Configuration File

3.1 The Configuration File

This chapter describes the configuration file for the Hercules Emulator. By default the configuration file is named "hercules.cnf" or "hercules.conf". It is located in the configuration directory, refer to the Hercules Installation Guide for details of the directory structure. The configuration file contains the processor definitions in the system parameters section, the device layout in the device definitions section and Hercules runtime parameters also in the system parameters section.

The configuration file - especially the device definition part - is roughly equivalent to the IOCDs definitions found on a real mainframe environment. It is an ASCII text file that is read and interpreted by the Hercules Emulator during its initialization phase.

3.2 System Parameters

The system parameters describe the processor definition and some Hercules internal runtime parameters.

The processor definitions include the processor model, CPU serial number, memory configuration and architecture mode. They describe the processor hardware that is to be emulated.

The Hercules runtime parameters define values that Hercules requires as an emulated environment. These parameters include values like port numbers, directory paths and priorities.

The following table shows an overview of all valid system parameters:

System Parameter	Description
# or *	Comment line
ARCHMODE	Initial architecture mode
ASN_AND_LX_REUSE / ALRF	ESAME ASN and LX REUSE feature
AUTOMOUNT	Tape automount root directory
AUTO_SCSI_MOUNT	Automatic SCSI tape mounts
CCKD	Compressed CKD DASD options
CNSLPORT	Telnet client port
CODEPAGE	Codepage conversion table
CONKPALV	Console and telnet clients keep-alive option
CPUMODEL	CPU model
CPUPRIO	CPU thread process priority
CPUSERIAL	CPU serial number

System Parameter	Description
CPUVERID	CPU version code
DEFSYM	Define symbol
DEVPRIO	Device threads process priority
DEVTMAX	Maximum number of device threads
DIAG8CMD	DIAGNOSE 8 command setting
ECPSVM	ECPS:VM support status (VM)
ENGINES	Processor engine type
HERCLOGO	Hercules 3270 logo
HERCPRIO	Hercules process priority
HTTPPORT	HTTP server port
HTTPROOT	HTTP server root directory
IGNORE	Ignore subsequent INCLUDE errors
INCLUDE	Include configuration file
IODELAY	I/O interrupt wait time (LINUX)
LDMOD	Additional dynamic load modules
LEGACYSENSEID	SENSE ID CCW (x'E4') feature
LOADPARM	IPL parameter
LOGOPT	Log options
LPARNAME	LPAR name returned by DIAG x'204'
LPARNUM	LPAR identification number
MAINSIZE	Main storage in MB
MANUFACTURER	Manufacturer name returned by STSI instruction
MAXCPU	Maximum number of CPUs
MODEL	Model names returned by STSI instruction
MODPATH	Dynamic load module path
MOUNTED_TAPE_REINIT	Control tape initialization

System Parameter	Description
NUMCPU	Number of emulated CPUs
NUMVEC	Number of vector facilities
OSTAILOR	Intended operating system
PANRATE	Panel refresh rate
PANTITLE	Hercules console window title
PGMPRDOS	LPP license setting
PLANT	Plant name returned by STSI instruction
SCLPROOT	SCLP base directory
SHCMDOPT	Shell command option
SHRDPORT	Shared device server port
SYSEPOCH	Base date for TOD clock
TIMERINT	Internal timer update interval
TODDRAG	TOD clock drag factor
TODPRIO	Timer thread process priority
TRACEOPT	Instruction trace display option
TZOFFSET	TOD clock offset from GMT
XPNDSIZE	Expanded storage in MB
YROFFSET	TOD clock offset from actual date

Table 1: Hercules System Parameters

3.3 Device Definitions

The device definitions describe the layout of the emulated hardware i.e: DASD, tape, terminals and printers. It is comparable with the IOCDs found in a real mainframe environment. Each emulated device must be specified in this part of the configuration file.

The following table shows an overview of all valid devices:

Device Type	Device	Emulated by
3270, 3278	Local non-SNA 3270 display or printer	TN3270 client connection
SYSG	Integrated 3270 (SYSG) console	TN3270 client connection
1052, 3215	Console printer-keyboards	Telnet client connection
1052-C, 3215-C	Integrated console printer-keyboards	Integrated on Hercules console
1442, 2501, 3505	Card readers	Disk file(s), ASCII or EBCDIC
3525	Card punch	Disk file, ASCII or EBCDIC
1403, 3211	Line printers	Disk file, ASCII
3410, 3420, 3422, 3430, 3480, 3490, 3590, 9347, 8809	Tape drives	Disk file, CD-ROM or SCSI tape
3088	Channel-to-Channel Adapter	"CTCT" driver
((CTCI))	Channel-to-Channel link to host TCP/IP stack	"CTCI" TUN/TAP driver
((LCS))	IBM 2216 router, IBM 3172 running ICP, IBM 8232 LCS device, LCS3172 driver of a P/390, IBM Open Systems Adapter (OSA)	"LCS" (LAN channel station) TUN/TAP driver
3310, 3370, 9313, 9332, 9335, 9336, 0671	FBA direct access storage devices	Disk file
2305, 2311, 2314, 3330, 3340, 3350, 3375, 3380, 3390, 9345	CKD direct access storage devices	Disk file
2703	Communication line	TCP socket

Table 2: Hercules Device Definitions

3.4 Coding Rules

There are only a few rules for creating configuration files. The file must be an ASCII text file. Blank lines, or lines beginning with a hash (" # ") sign or an asterisk (" * "), are treated as comments and are not checked.

The system parameters may appear in any order but must precede all device definitions. Each system parameter must be specified on a separate line.

The device records may also appear in any order but must follow the system parameters. There must be one device definition for each I/O device or for each group of identical I/O devices.

3.5 Record Format

The following sections describe the format of the Hercules configuration file records. The format is slightly different between system parameters and device definitions.

3.5.1 Format of the system parameters

The record format of the system parameters is as follows:

system-parameter argument

where:

system-parameter is the name of the system parameter.

argument is the value assigned to the system parameter.

Examples:

```
CPUMODEL  3090
HTTPROOT  /usr/local/share/hercules/
PANRATE   FAST
```

3.5.2 Format of the device definitions

The format of device definition is as follows:

devnum(s) devtype [argument(s)]

where:

devnum(s) is either: a single devnum (see details below), a range of devnums separated by a dash ("-"), a count of devnums separated by a dot ("."), or a comma (",") separated list of devnums.

Examples include:

- 0200-0210
- 0300.10
- 0400,0410
- 0100,0110-011F

If devnums specifies more than one device then all devices will have identical characteristics. All devices defined as a group must be defined on a single channel. A channel is defined as a continuous group of

256 (or hexadecimal 100) devices. For example devices 0010 and 0020 are on the same channel, whereas devices 0100 and 0210 are not on the same channel.

The devnum itself is either a 1 to 4 digit hexadecimal number in the range 0000 to FFFF for ESA/390 or 0000 to 0FFF for S/370. The device number uniquely identifies each device to the operating system.

devtype is the device type.

argument(s) is a list of parameters depending on the device type. These parameters are explained in the sections that describe each device type.

Examples:

```
0120      3380  mvsv5r.120
0230.16   3270  GROUP1 192.168.100.0 255.255.255.0
0583-0587 3420  *  maxsizeM=170  eotmargin=131072
```

3.6 Sample Configuration File

The following figure shows a real example of a Hercules configuration file, used for running the MVS 3.8J operating system. Please note, that not all possible parameter and definitions are contained in this sample.

```
#
# Hercules Emulator Control file...
# Description: MVS V3.8J
# MaxShutdownSecs: 60
#
#
# System parameters
#
CPUMODEL      7490                # CPU model
CPUSERIAL     001963              # CPU serial number
CPUVERID      FD                  # CPU version code
LPARNAME      HERCULES            # LPAR name returned by DIAG X'204'
MODEL         EMULATOR           # Model name returned by STSI
PLANT         ZZ                  # Plant name returned by STSI
MANUFACTURER  HRC                 # Manufacturer name returned by STSI
MAINSIZE      16                  # Main storage in MB
XPNDSIZE      0                   # Expanded storage in MB
CODEPAGE      DEFAULT             # Codepage conversion table
CNSLPORT      3270                # TELNET client port
NUMCPU        2                   # Number of emulated CPU's
NUMVEC        0                   # Number of vector facilities
ARCHMODE      S/370               # Initial architecture mode
LOADPARM      0148....           # IPL parameters
SYSEPOCH      1928                # Base date for TOD clock
TZOFFSET      +0000              # TOD clock offset from GMT
```

```

OSTAILOR      OS/390          # Intended operating system
PANRATE       1000           # Panel refresh rate in ms
PANTITLE      MVS_V3.8J     # Console window panel title
LOGOPT        TIMESTAMP     # Hercules log options
CONKPALV      (3,1,10)     # Console and telnet clients keep-alive option
DEVTMAX       0             # Maximum number of device threads
PGMPRDOS      LICENSED     # Do not emulate IFL hardware
SHCMDOPT      NODIAG8      # SHELL command behaviour
DIAG8CMD      DISABLE      # DIAGNOSE 8 command setting
ASN_AND_LX_REUSE  DISABLE  # ESAME 'ASN and LX REUSE' optional feature
AUTO_SCSI_MOUNT NO        # Automatic detection of SCSI tape mounts
IODELAY       0             # I/O interrupt wait time (Linux only)
ECPSVM        NO           # ECPS:VM support status (VM only)
HERCPRIO      0            # Hercules process priority
CPUPRIO       0            # CPU thread process priority (default: 15)
DEVPRIO       0            # Device threads process priority (default: 8)
TODPRIO      -20          # Timer thread process priority
TIMERINT      DEFAULT     # Internal timers update interval
HTTPROOT      D:/Hercules/html # HTTP server root directory
HTTPPORT      8081 AUTH p390 fzrx6v # HTTP server port / authorization required
SHRDPOR       3990        # Shared devcice server port
DEFESYM       DASDPATH D:/MVS/DASD # Define path for DASD devices

#
# Device Definitions
#

# Card Readers

000C  3505  D:/MVS/JCL/DUMMY.JCL eof ascii trunc

# Card Punches

000D  3525  D:/MVS/PCH/pch00d.txt ascii crlf

# Line Printers

000E  1403  D:/MVS/PRT/prt00e.txt crlf
000F  1403  D:/MVS/PRT/prt00f.txt crlf
030E  1403  D:/MVS/LOG/hardcopy.log crlf

# Display Terminals

0010  3270  *  192.168.0.100
0011  3270  *  192.168.0.100
00C0  3270  *  192.168.0.100
00C1  3270  *  192.168.0.100
00C2  3270  *  192.168.0.100
00C3  3270  *  192.168.0.200
00C4  3270  *  192.168.0.200
00C5  3270  *  192.168.0.200
00C6  3270  *
00C7  3270  *

```

```

# DASD Devices

0130 2314 D:/MVS/DASD/SORT00.130c
0131 2314 D:/MVS/DASD/SORT01.131c
0132 2314 D:/MVS/DASD/SORT02.132c
0133 2314 D:/MVS/DASD/SORT03.133c
0134 2314 D:/MVS/DASD/SORT04.134c
0135 2314 D:/MVS/DASD/SORT05.135c
0140 3350 D:/MVS/DASD/WORK00.140c
0141 3350 D:/MVS/DASD/WORK01.141c
0142 3350 D:/MVS/DASD/PRD000.142c
0143 3350 D:/MVS/DASD/PRD001.143c
0144 3350 D:/MVS/DASD/PRD002.144c
0145 3350 D:/MVS/DASD/PRD003.145c
0148 3350 D:/MVS/DASD/MVSRES.148c
0149 3350 D:/MVS/DASD/MVSDLB.149c
0160 3340 D:/MVS/DASD/PAGE00.160c
0161 3340 D:/MVS/DASD/PAGE01.161c
0240 3350 D:/MVS/DASD/PUB000.240c
0241 3350 D:/MVS/DASD/PUB001.241c
0242 3350 D:/MVS/DASD/PUB002.242c
0243 3350 D:/MVS/DASD/PUB003.243c
0248 3350 D:/MVS/DASD/SYS000.248c
0249 3350 D:/MVS/DASD/SYS001.249c
024A 3350 D:/MVS/DASD/SYS002.24Ac
024B 3350 D:/MVS/DASD/SYS003.24Bc
0340 3350 D:/MVS/DASD/CBT000.340c
0341 3350 D:/MVS/DASD/CBT001.341c
0342 3350 D:/MVS/DASD/CBT002.342c
0343 3350 D:/MVS/DASD/CBT003.343c
0344 3350 D:/MVS/DASD/SPOOL0.344c
0345 3350 D:/MVS/DASD/SPOOL1.345c
0348 3350 D:/MVS/DASD/TST000.348c
0349 3350 D:/MVS/DASD/TST001.349c
034A 3350 D:/MVS/DASD/TST002.34Ac
034B 3350 D:/MVS/DASD/TST003.34Bc

```

```

# TAPE Devices

0480 3420 * MAXSIZEM=210 EOTMARGIN=131072
0481 3420 * MAXSIZEM=210 EOTMARGIN=131072
0482 3420 * MAXSIZEM=210 EOTMARGIN=131072
0483 3420 * MAXSIZEM=210 EOTMARGIN=131072

```

Figure 1: Sample Configuration File

3.7 Symbol Substitution

In configuration and device statements, as well as in console commands and OAT files, symbols may be substituted for text.

3.7.1 Syntax

To substitute symbol *symbol* with its contents the symbol should be enclosed within parenthesis and preceded by a \$ sign. For example, if symbol *FOO* contains the text string "*BAR*" then $\$(FOO)$ will be substituted with the string "*BAR*". Symbol names are case sensitive.

3.7.2 Examples

```
...
DEFSYM TAPEDIR "/home/hercules/tapes"
...
0380 3420 $(TAPEDIR)/scratch.aws
...
```

In the above example device 0380 will be a 3420 loaded with the AWSTAPE file in the directory "/home/hercules/tapes/scratch.aws".

3.7.3 Special symbols

3.7.3.1 Device group symbols

When multiple devices are defined with a single device definition, then the following symbols may be used. These are defined as containing the relevant device address for each device:

- CUU 3 digit device number, upper case hexadecimal digits
- CUUU 4 digit device number, upper case hexadecimal digits
- cuu 3 digit device number, lower case hexadecimal digits
- cuuu 4 digit device number, lower case hexadecimal digits

Example:

```
0200,0201 3340 /home/hercules/dasds/myvols.$(CUU)
```

will define 2 3340 packs with device 0200 being loaded from the file "myvols.200" and device 0201 defined from "myvols.201".

3.7.3.2 Environment variables

If a symbol is not explicitly defined by a DEFSYM statement and an environment variable by the same name exists, then the string contents of that environment variable will be used for substitution.

3.7.3.3 Undefined symbols

If a symbol is not defined by an explicit DEFSYM, is not an automatically generated symbol or is not an environment variable, an empty string will be substituted.

3.7.4 Escaping substitution, recursion

To specify the '\$' string without incurring substitution an additional '\$' sign should be used. For example, \$\$\$(FOO) will not be substituted. If substitution is required but the preceding text is to contain a '\$' sign as the very last character then \$\$\$\$(FOO) would be specified. Thus if symbol FOO contains "BAR", then \$\$\$(FOO) will remain "\$\$(FOO)" while \$\$\$\$(FOO) will become "\$BAR". Substitution is not recursive, only one substitution pass is made.

3.8 Enhanced Symbol Substitution

Enhanced symbol substitution is an additional method for specifying symbols. It differs from the above normal symbol substitution in several important ways.

3.8.1 Differences from conventional Symbol Substitution

The syntax of the enhanced symbol substitution differs from conventional symbol substitution. Enhanced substitution symbol names are specified using "\${var}" (dollar sign and brace) rather than "\$(var)" (dollar sign and parenthesis).

This enhanced syntax supports the specification of a default value that will be used whenever the named symbol is not otherwise defined. The default value is placed within the opening and closing braces just as the symbol name is but separated from it by either a single equal sign "=" or a colon-equal-sign "=". For example, specifying "\${DASD_PATH=dasd/}" in your configuration file will result in the value of the "DASD_PATH" symbol or environment variable being substituted, or if the variable is undefined, the value "dasd/" instead. If no default value is specified then an empty string will be used instead.

An important distinction of enhanced symbol substitution is that it only occurs from host defined environment variables and not from any identically named DEFSYM symbol should one exist. For example, if environment variable "FOO" is defined with the value "bar", then the configuration file statement "DEFSYM FOO myfoo", followed immediately by the statement "\${FOO}" causes the value "bar" to be substituted and not "myfoo" as might be expected. Whereas the statement "\${FOO}", since it is a normal symbol substitution sequence, will be substituted with "myfoo", the value defined by the preceding DEFSYM statement.

To clarify, the two symbol substitution techniques are supported completely separately from each other. DEFSYM allows you to use previously defined or undefined, private (internally defined), symbols separate from the host operating system's environment variable pool. Enhanced symbol substitution allows read-only access to the host environment variable pool with no support for modifying an already defined symbol (environment variable), however with a convenient means of defining a default value to be used should the specified host environment variable be currently undefined.

It is important to note that symbol names, potentially being the names of environment variables, are subject to whatever case sensitivity the host operating system happens to enforce or allow. Under Windows environment variables are not case sensitive, whereas on other operating systems they may be. Thus "\${FOO}", "\${foo}", "\${Foo}" etc, all cause the same value to be substituted on Windows, whereas the DEFSYM symbols \$(FOO) and \$(foo), could be substituted with two completely different values under a case sensitive operating system. IE: the Hercules implementation of DEFSYM is case sensitive across all supported platforms.

3.8.2 Syntax

To substitute symbol *symbol* with the current environment variable value, the symbol should be enclosed within braces and preceded by a \$ sign. For example, if an environment variable named FOO holds the

value "BAR", then `${FOO}` will be substituted with the string "BAR". If the environment variable "FOO" is not defined then a null (empty) string is substituted instead.

If the string `"${FOO:=myfoo}"` is used instead, then the value "BAR" will still be substituted if the value "BAR" was previously assigned to FOO, but will be substituted with the value "myfoo" instead if the environment variable FOO is currently undefined.

Note too that the default value is a literal string and no substitution is applied to it. Thus attempting to use the syntax `"${foo=${bar}}"` will not yield the expected results. It will not be substituted with the currently defined value of the "bar" environment variable, but rather by the literal string `"${bar}"` followed immediately by the literal character `'`.

Symbol names (environment variable names) are not case sensitive on Windows whereas they might be on other host operating systems.

3.8.3 Examples

```
...  
0120 3390  ${DASD_PATH=dasd/}  mvsv5r.120  
...
```

In the above example, device 0120 will be a 3390 loaded with the DASD file from the directory specified in the environment variable "DASD_PATH" or, if the DASD-PATH environment variable is not defined, the value "dasd/" instead.

4. System Parameter Descriptions

4.1 # or * (Comment lines)

4.1.1 Function

The hash (“#”) or asterisk (“*”) symbols mark the beginning of a comment or a full comment line.

4.1.2 Syntax

Descriptive

[*anything*]

or

* [*anything*]

Diagram

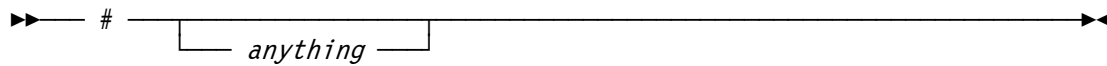

or

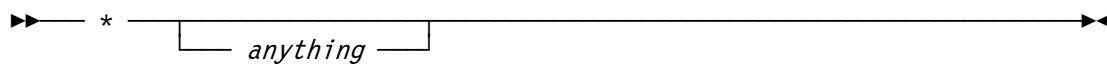

4.1.3 Parameter

anything Any text following the hash or asterisk symbol.

4.1.4 Examples

Example 1:

Add comment lines to the configuration file and add comment after the system parameter.

```
*****
* System Parameters                               *
*****
NUMCPU    2      # Number of emulated CPUs
MAINSIZE 1024   # Main storage in MB
```

4.2 ARCHMODE (Initial architecture mode)

4.2.1 Function

The archmode parameter specifies the initial architecture mode.

4.2.2 Syntax

Descriptive

ARCHMODE {S/370 | ESA/390 | ESAME | z/ARCH}

Diagram

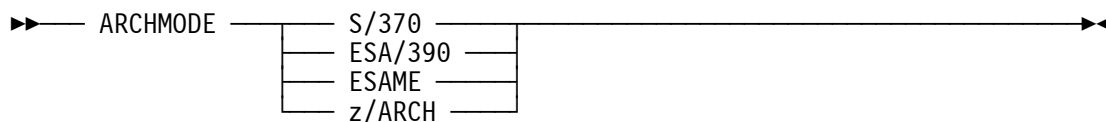

4.2.3 Parameter

S/370 Use S/370 for OS/360, VM/370 and MVS 3.8

ESA/390 Use ESA/390 for MVS/XA, MVS/ESA, OS/390, VM/ESA, VSE/ESA, Linux/390 and ZZSA. z/OS can be run until version 1.2 with ESA/390 mode without installed bimodal feature or until version 1.4 if the bimodal feature is installed.

ESAME Use ESAME (Enterprise System Architecture, Modal Extensions) for z/OS, z/VM, z/VSE and z/Linux. When ESAME is specified, the machine will always be IPL'ed in ESA/390 mode but the system is capable of being switched into the z/Architecture mode after IPL. This is handled automatically by all z/Architecture operating systems.

z/ARCH This is the same as ESAME.

4.2.4 Examples

Example 1:

Specify ESA/390 architecture mode.

```
ARCHMODE ESA/390
```

4.3 ASN_AND_LX_REUSE / ALRF (ESAME ASN and LX REUSE feature)

4.3.1 Function

This parameter specifies if the “ASN and LX Reuse Facility” is to be disabled (the default) or enabled. The ASN_AND_LX_REUSE parameter can be abbreviated as ALRF.

4.3.2 Syntax

Descriptive

ASN_AND_LX_REUSE {DISABLE | ENABLE}

or

ALRF {DISABLE | ENABLE}

Diagram

▶▶ ASN_AND_LX_REUSE ————

DISABLE
ENABLE

 —————▶▶

or

▶▶ ALRF ————

DISABLE
ENABLE

 —————▶▶

4.3.3 Parameter

DISABLE The “ASN and LX Reuse Facility” is disabled. This is the default and is always disabled for S/370 and ESA/390 modes. Set it to **DISABLE** if the operating system does not support this feature and it inadvertently sets CR0 bit 44 to 1, usually leading to an unexpected program interrupt when instructions such as LASP are issued.

ENABLE The “ASN and LX Reuse Facility” is enabled. Set this parameter to **ENABLE** if the operating system supports this z/Architecture feature and the use of this feature is desired.

4.3.4 Examples

Example 1:

Enable the ASN and LX Reuse Facility.

```
ASN_AND_LX_REUSE ENABLE
```

4.4 AUTOMOUNT (Tape automount root directory)

4.4.1 Function

Specifies the host system directory where the guest is allowed or not allowed to automatically load virtual tape volumes from. Prefix allowable directories with a '+' (plus) sign and unallowable directories with a '-' (minus) sign. The default prefix if neither is specified is the '+' sign (an allowable directory).

All host system virtual tape volumes to be automounted by the guest must reside within one of the specified allowable host system directories or any of its subdirectories while not also being within any of the specified unallowable directories or any of their subdirectories, in order for the guest-invoked automount to be accepted.

Specifying a disallowed automount directory does not preclude the Hercules operator from manually mounting any file via the DEVINIT console command - even one in a currently defined disallowed automount directory. The AUTOMOUNT statement only controls guest-invoked automatic tape mounts and not manual tape mounts performed by the Hercules operator.

All directories must be specified on separate statements, but as many statements as needed may be specified in order to describe the desired allowable/unallowable directories layout. For convenience, an AUTOMOUNT console command is also provided to dynamically add new or remove existing automount directories at any time.

The automount feature is activated whenever you specify at least one allowable or unallowable directory. If only unallowable directories are specified, then the current directory becomes the only defined allowable automount directory by default.

All specified directories are always resolved to fully-qualified absolute directory paths before being saved.

Caution: Enabling this feature may have security consequences depending on which allowable host system directories you specify as well as how your guest operating system enforces authorized use of the Set Diagnose (X'4B') channel command code.

Refer to the description of the virtual tape device 'NOAUTOMOUNT' option for more information.

4.4.2 Syntax

Descriptive

AUTOMOUNT [\pm | -] *directory*

or

AUTOMOUNT {ADD *directory* | DEL *directory*}

Diagram

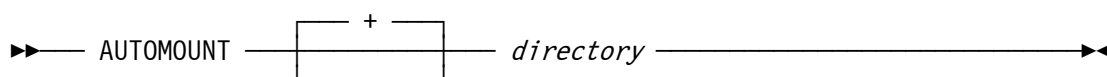

or

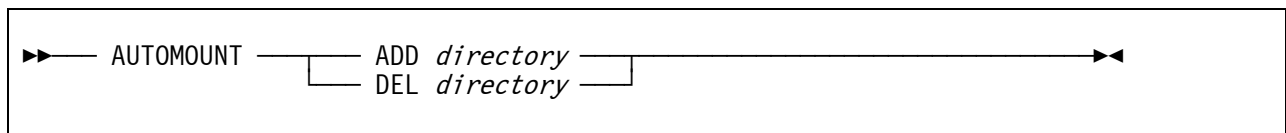

4.4.3 Parameter

- ADD or +** Add an entry to the list of allowable tape automount directories.
- DEL or -** Delete an entry from the list of allowable tape automount directories.
- directory** Specifies the host system directory where the guest is allowed or not to automatically load virtual tape volumes from.

4.4.4 Examples

Example 1:

Specify directory "D:\MVS\TAPE" as the host system directory from where the guest is allowed to automatically load virtual tape volumes.

```

AUTOMOUNT +D: /MVS/TAPE
      or
AUTOMAOUNT ADD D: /MVS/TAPE
  
```

4.5 AUTO_SCSI_MOUNT (Automatic SCSI tape mounts)

4.5.1 Function

The AUTO_SCSI_MOUNT parameter specifies whether automatic detection of SCSI tape mounts are enabled or not.

NOTE! Enabling this option may negatively impact Hercules performance depending on how the host operating system (Windows, Linux etc.) handles SCSI attached tape drive status queries.

4.5.2 Syntax

Descriptive

AUTO_SCSI_MOUNT {NO | YES | *n*}

Diagram

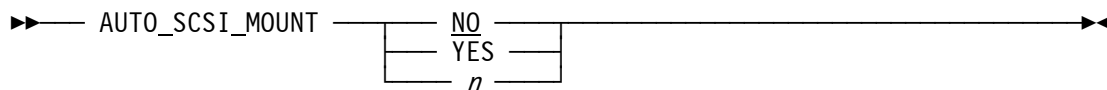

4.5.3 Parameter

- NO** NO indicates that the SCSIMOUNT option is disabled, forcing all SCSI tape mounts to be done manually via an appropriate DEVINIT command.
- YES** Yes enables the option and causes periodic queries of the SCSI tape drive in a five second interval to automatically detect when a tape is mounted. YES is equivalent with "SCSIMOUNT 5".
- n** A value from 1 to 99 seconds (inclusive) enables this option and causes periodic queries of the SCSI tape drive to automatically detect if a tape is mounted.

4.5.4 Examples

Example 1:

Enable automatic detection of SCSI tape mounts and set the periodic queries of the SCSI tape drive to a 30 seconds interval.

```
AUTO_SCSI_MOUNT 30
```

4.6 CCKD (Compressed CKD DASD options)

4.6.1 Function

The CCKD configuration statement is used to alter CCKD processing. The CCKD configuration statement supports the same options as the CCKD console command.

4.6.2 Syntax

Descriptive

```
CCKD option=value [,option=value [,option=value ... ]]
```

where option can be:

```
[COMP={-1 | n}]
```

```
[,COMPPARM={-1 | n}]
```

```
[,RA={2 | n}]
```

```
[,RAQ={4 | n}]
```

```
[,RAT={2 | n}]
```

```
[,WR={2 | n}]
```

```
[,GCINT={10 | n}]
```

```
[,GCPARM={0 | n}]
```

```
[,NOSTRESS={0 | 1}]
```

```
[,FREEPEND={-1 | n}]
```

```
[,FSYNC={0 | 1}]
```

```
[,TRACE={0 | n}]
```

```
[,LINUXNULL={0 | 1}]
```

```
[,GCSTART={0 | 1}]
```

Diagram

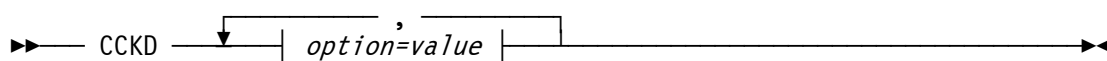

COMP=

COMPPARM=

RA=

RAQ=

RAT=

WR=

GCINT=

GCPARM=

NOSTRESS=

FREPEND=

FSYNC=

TRACE=

LINUXNULL=

GCSTART=

4.6.3 Parameter

option Set a CCKD option. Multiple options may be specified separate by commas with no intervening blanks.

The CCKD options are:

COMP=n Specifies the compression type to be used. This overrides the compression used for all CCKD files. The default (-1) means don't override the compression. Valid compression types are:

-1 Default

0 None

1 zlib

2 bzip2

COMPPARM=n Overrides the compression parameter. A higher value generally means more compression at the expense of CPU and/or storage. The default (-1) means don't override the compression parameter. The value of *n* can be from -1 and 9.

RA=n Sets the Number of readahead threads. When sequential track or block group access is detected, some number (RAT=*n*) of tracks or block groups are queued (RAQ=*n*) to be read by one of the readahead threads. The default is 2, the value of *n* can be a number from 1 to 9.

RAQ=n Sets the size of the readahead queue. When sequential track or block group access is detected, some number (RAT=*n*) of tracks or block groups are queued in the readahead queue. The default is 4, the value of *n* can be a number from 0 to 16. A value of zero disables readahead.

RAT=n Sets the number of tracks or block groups to readahead when sequential track or block group access is detected. The default is 2, the value of *ratn* can be a number from 0 to 16. A value of zero disables readahead.

WR=n Sets the number of writer threads. When the cache is flushed, updated cache entries are marked write pending and a writer thread is signalled. The writer thread compresses the track or block group and writes the compressed image to the emulation file. A writer thread is cpu-intensive while compressing the track or block group and I/O-intensive while writing the compressed image. The writer thread runs one nicer than the CPU thread(s). The default is 2, a value from 1 to 9 can be specified

GCINT=n This is the number of seconds the garbage collector thread waits during an interval. At the end of an interval the garbage collector performs space recovery, flushes the cache and optionally fsyncs the emulation file. However, the file will not be fsynced unless at least 5 seconds have elapsed since the last fsync. The default is 10 seconds. You can specify a number between 1 to 60.

GCPARM=n A value affecting the amount of data moved during the garbage collector's space recovery routine. The garbage collector determines an amount of space to move based on the ratio of free space to used space in an emulation file and on the number of free spaces in the file. The garbage collector wants to reduce the free space to used space ratio and the number of free spaces. The value is logarithmic; a value of 8 means moving 2^8 the selected value while a negative value similarly decreases the amount to be moved. Normally, 256K will be moved for a file in an interval. Specifying a value of 8 can increase the amount to 64M. At least 64K will be moved. Specifying a large value (such as 8) may not increase the garbage collection efficiency correspondingly. The default is 0. You can specify a number from -8 to 8.

- NOSTRESS=n** Indicates whether stress writes will occur or not. A track or block group may be written under stress when a high percentage of the cache is pending write or when a device I/O thread is waiting for a cache entry. When a stressed write occurs, the compression algorithm and/or compression parm may be relaxed, resulting in faster compression but usually a larger compressed image. If NOSTRESS is set to one, then a stressed situation is ignored. You would typically set this value to one when you want create the smallest emulation file possible in exchange for a possible performance degradation. The default is 0. You can specify 0 (enable stressed writes) or 1 (disable stressed writes).
- FREEPEND=n** Specifies the free pending value for freed space. When a track or block group image is written, the space it previously occupied is freed. This space will not be available for future allocations until *n* garbage collection intervals have completed. In the event of a catastrophic failure, previously written track or block group images should be recoverable if the current image has not yet been written to the physical disk. By default the value is set to -1 which means that if fsync is specified then the value is 1 otherwise it is 2. If 0 is specified then freed space is immediately available for new allocations. The default is -1. You can specify a number from -1 to 4.
- FSYNC=n** Enables or disables fsync. When fsync is enabled then the disk emulation file is synchronized with the physical hard disk at the end of a garbage collection interval (no more often than 5 seconds though). This means that if freepend is non-zero and a catastrophic error occurs, the emulated disks should be recovered coherently. However, fsync may cause performance degradation depending on the host operating system and / or the host operating system level. The default is 0 (fsync disabled), you can specify 0 (disable fsync) or 1 (enable fsync).
- TRACE=n** Specifies the number of cckd trace entries. You would normally specify a non-zero value when debugging or capturing a problem in cckd code. When the problem occurs, you should enter the "k" Hercules console command which will print the trace table entries. The default is 0. You can specify a number between 0 and 200000. Each trace entry represents 128 bytes. Normally, for debugging, it is recommended to use 100000.
- LINUXNULL=n** If set to 1 then tracks written to 3390 CCKD volumes that were initialized with the *-linux* option will be checked if they are null (that is if all 12 4096 byte user records contain zeroes). This is used by the DASDCOPY utility. The default is 0.
- GCSTART=n** If set to 1 then space recovery will become active on any emulated disks that have free space. Normally space recovery will ignore emulated disks until they have been updated. The default is 0.

Notes:

- The size of the *cache* is difficult to determine. The storage used by the cache is also be used for emulated virtual storage. You do not want to steal storage from your emulated operating system such that it starts paging heavily. You also do not want your host operating system to page. However, you do not want your cache to flush too often as cpu cycles would be stolen from the cpu thread that compresses updated images.
- You need at least one *l2cache* entry per compressed device. Since the maximum number of *l2cache* entries is 1024, this implies that no more than 1024 compressed devices can be defined. If you have a large number of devices then specify the maximum value otherwise the default should suffice.
- *raq* should be at least as large as *ra*. Readahead threads are scheduled from entries in the readahead queue. Likewise *rat* should not exceed *raq* because only *raq* tracks or block groups can be queued at any time.
- The number of writer threads *wr* should usually be 1 more than the number of host processors. This is because one writer thread could be cpu-bound (compressing a track or block-group image) and the other could be i/o-bound (writing the compressed image).

- The garbage collection interval governs the maximum time in seconds an updated track or block group image will reside in storage before being written to the emulation file. A large value may mean more data loss if a catastrophic error occurs. A small value may mean that more cpu time is spent compressing images.

For example, suppose that a particular image is updated several times each second. If the interval is changed from the default 5 seconds to 1 second, then that image will be compressed and written 5 times more frequently. A large value may cause more cache flushes within a garbage collection interval. These kind of flushes mean that a read will wait because there are no available cache entries, slowing the emulated operating system. A large value will also cause more pending free space to build up (since free space is flushed each interval). This may mean that the garbage collector space recovery routine will perform more work and the resulting emulation file may be larger.

- Specify *fsync=1* and *gcint=5* if you are seriously concerned about your data being lost due to a failure. *fsync* will ensure your data on disk is coherent. However, *fsync* may cause a noticeable performance degradation. Note that an *fsync* will not be performed more often than every 5 seconds.
- In general, it is recommended to use default options and adjust them only if you have good reason to do so.

4.6.4 Examples

Example 1:

Set the CCKD options to use bzip2 as compression method and using maximum compression.

```
CCKD COMP=2 , COMPPARM=9
```

Example 2:

Set the CCKD options to use the default compression method, as well as default compression. Disable stressed writes and set the number of trace entries to 100000.

```
CCKD COMP=-1 , COMPPARM=-1 , NOSTRESS=1 , TRACE=100000
```

4.7 CNSLPORT (Telnet client port)

4.7.1 Function

The CNSLPORT parameter specifies the port number (in decimal), on which the telnet server will listen. The statement may also have the form `host:port`, where the telnet console server will bind to the specified address.

4.7.2 Syntax

Descriptive

CNSLPORT {3270 | *port* | *host:port*}

Diagram

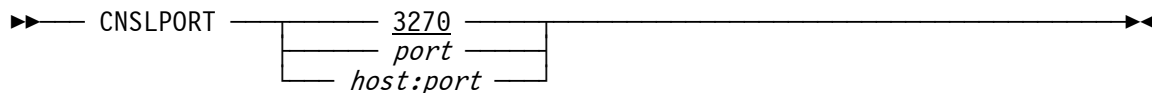

4.7.3 Parameter

- host** The IP address of the host to which the telnet server will bind to. If an IP address is given then it must be a valid IP address for the host system.
- port** The port number (decimal) on which the telnet server will listen. The port number must not be in use by any other server. Ports below 1024 cannot be used unless Hercules is running as root or is otherwise authorized to use low ports.

4.7.4 Examples

Example 1:

Set the port number on which the telnet server will listen to 3270.

```
CNSLPORT 3270
```

Example 2:

Specify 192.168.1.10 as the IP address of the host to which the telnet server will bind to and set the port number on which the telnet server will listen to 3270.

```
CNSLPORT 192.168.1.10:3270
```

4.8 CODEPAGE (Codepage conversion table)

4.8.1 Function

This parameter specifies the codepage conversion table used for the ASCII / EBCDIC translation. If no codepage is given the environment variable HERCULES_CP will be inspected. The default codepage used is "DEFAULT".

4.8.2 Syntax

Descriptive

CODEPAGE {DEFAULT | *codepage*}

Diagram

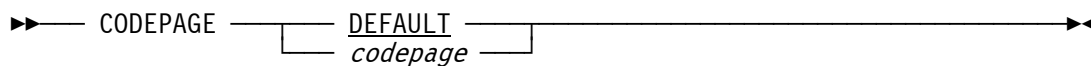

4.8.3 Parameter

codepage Specifies the codepage conversion table used for ASCII / EBCDIC translation. Supported codepage mappings are shown in the table below. Iconv single byte codepages may also be used (e.g. "UTF8/EBCDIC-CP-NL").

Mapping	ASCII	EBCDIC
437/037	437 PC United States	037 United States/Canada
437/500	437 PC United States	500 Latin 1
850/273	850 PC Latin 1	273 Austria/Germany
819/273	819 ISO-8859-1	273 Austria/Germany
819/277	819 ISO-8859-1	277 Denmark/Norway
819/278	819 ISO-8859-1	278 Finland/Sweden
819/280	819 ISO-8859-1	280 Italy
819/284	819 ISO-8859-1	284 Spain
819/285	819 ISO-8859-1	285 United Kingdom
819/297	819 ISO-8859-1	297 France
819/500	819 ISO-8859-1	500 International
437/1047	437 PC United States	1047 Open Systems Latin 1

819/1047	819 ISO-8859-1	1047 Open Systems Latin 1
1252/1047	1252 Windows Latin 1	1047 Open Systems Latin 1
850/1047	850 PC Latin 1	1047 Open Systems Latin 1

Table 3: Supported codepage mappings

DEFAULT DEFAULT specifies the traditional Hercules codepage.

4.8.4 Examples

Example 1:

Set the codepage conversion table to the default.

```
CODEPAGE DEFAULT
```

Example 2:

Set the codepage conversion table to 437/500.

```
CODEPAGE 437/500
```

4.9 CONKPALV (Console and telnet clients keep-alive option)

4.9.1 Function

The CONKPALV parameter specifies the tn3270 console and telnet clients keep-alive option values that control automatic detection of disconnected tn3270 / telnet client sessions.

This is a built-in feature of TCP/IP that allows detection of unresponsive TCP/IP connections and not idle clients; the connection will not be terminated after the specified idle time. The 3270 sessions can remain idle for a long time without any data being transmitted. The TCP/IP Keep-Alive feature only detects unresponsive TCP/IP stacks. Thus, even if the 3270 client is completely idle, the systems TCP/IP stack itself still should respond to the keep-alive probes sent from the Hercules end of the link. If it does not however, then the TCP/IP connection is obviously down and the 3270 sessions at the Hercules end of the link are terminated as a consequence.

Some older platforms may ignore all of the specified values and use platform specific values instead.

4.9.2 Syntax

Descriptive

CONKPALV {(3,1,10)} | (*idle, intv, count*)

Diagram

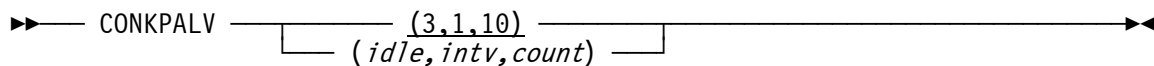

4.9.3 Parameter

idle The *idle* value specifies the number of seconds of inactivity until the first keep-alive probe is sent. The default for the *idle* value is 3 seconds.

intv The *intv* value specifies the interval in seconds between the probes if no acknowledgement is received from the previous probe. The default for *intv* is 1 second.

count The *count* value specifies the number of unacknowledged keep-alive packets sent before the connection is considered to have failed. The default value is 10.

Note: On Windows platforms the count value is ignored and cannot be changed from its default value of 10.

4.9.4 Examples

Example 1:

Set the tn3270 console and telnet clients keep-alive option settings to the following values: 5 seconds of inactivity until the first keep-alive probe is sent, 3 seconds for the interval between the probes and to 15 unacknowledged keep-alive packets sent before the connection is considered to have failed.

```
CONKPALV ( 5 , 3 , 15 )
```

4.10 CPUMODEL (CPU model)

4.10.1 Function

The CPUMODEL parameter specifies the 4 hexadecimal digit CPU model number stored by the STIDP instruction.

4.10.2 Syntax

Descriptive

CPUMODEL {0586 | *model*}

Diagram

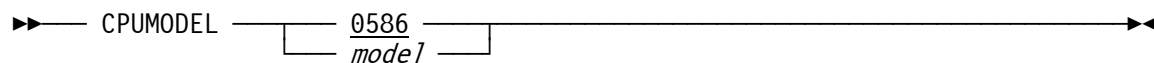

4.10.3 Parameter

model Any valid 4 digit hexadecimal CPU model number. A list of the valid model numbers can be found in the Hercules Windows GUI file “cpu-types.txt”. The default (“0586”) is not a mainframe CPU model number, but is related to the underlying PC architecture.

4.10.4 Examples

Example 1:

Specify a 7490 CPU model.

```
CPUMODEL 7490
```

Example 2:

Specify a 3090 CPU model.

```
CPUMODEL 3090
```

4.11 CPUPRIO (CPU thread process priority)

4.11.1 Function

CPUPRIO specifies the priority of the CPU thread. Default is a nice value of 15, which means a low priority such that I/O can be scheduled and completed in favour of CPU cycles. On multi-CPU systems a real CPU can be “dedicated” to Hercules by giving the CPU-thread a very high dispatching priority (-20).

Caution: CPUPRIO should not have a higher dispatching priority than the TOD clock and timer thread.

4.11.2 Syntax

Descriptive

CPUPRIO { 15 | *nn* }

Diagram

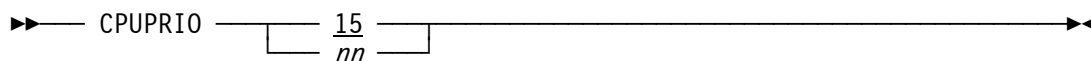

4.11.3 Parameter

nn This value specifies the priority for the CPU thread. For details on the priority values see section 4.57 (“Process and Thread Priorities”). The default is 15.

4.11.4 Examples

Example 1:

Give the CPU-thread a very high dispatching priority of -20.

```
CPUPRIO -20
```

4.12 CPUSERIAL (CPU serial number)

4.12.1 Function

CPUSERIAL specifies the 6 hexadecimal digit CPU serial number stored by the STIDP instruction.

4.12.2 Syntax

Descriptive

CPUSERIAL {000001 | *serial*}

Diagram

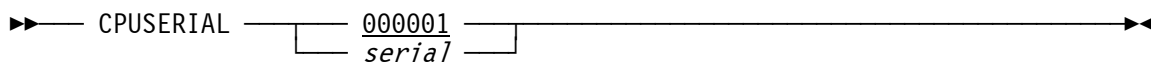

4.12.3 Parameter

serial Any valid 6 digit hexadecimal CPU serial number. The default serial number is 000001.

4.12.4 Examples

Example 1:

Set the CPU serial number to 001963.

```
CPUSERIAL 001963
```

4.13 CPUVERID (CPU version code)

4.13.1 Function

CPUVERID specifies the 2 hexadecimal digit CPU version code stored by the STIDP instruction. The default version code is “FD” when ARCHMODE S/370 or ARCHMODE ESA/390 is specified. For the z/ARCH (or ESAME architecture mode respectively) the version code is always stored as “00” and any value specified here is ignored.

4.13.2 Syntax

Descriptive

CPUVERID 00 (For z/ARCH and ESAME)

CPUVERID {FD | *verid*} (For S/370 and ESA/390)

Diagram

For z/ARCH and ESAME:

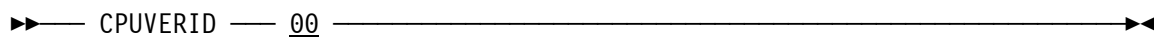

For S/370 and ESA/390:

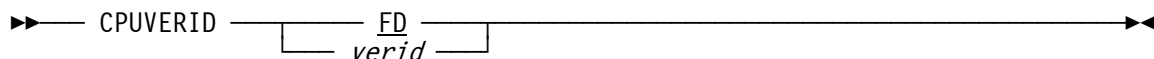

4.13.3 Parameter

verid Any valid 2 digit hexadecimal CPU version code. A list of valid version codes can be found in the Hercules Windows GUI file “cpu-types.txt”.

4.13.4 Examples

Example 1:

Set the CPU version code to FD.

```
CPUVERID FD
```

4.14 DEFSYM (Define symbol)

4.14.1 Function

Defines symbol *symbol* is to contain value *value*. The symbol can then be the object of a substitution used later in the configuration file or for console commands. If *value* contains blanks or spaces it must be enclosed within quotes or apostrophes. See chapter “Symbol Substitutions” for a more in-depth discussion on this feature.

Substitution is available in configuration statements, meaning it is possible to perform substitution in the *DEFSYM* statement itself. However, symbols are always defined as the last step in the process, so attempting to self define a symbol will result in an empty string.

4.14.2 Syntax

Descriptive

```
DEFSYM symbol value
```

Diagram

```
▶— DEFSYM — symbol — value —▶
```

4.14.3 Parameter

symbol The name of a symbol.
value The value that is assigned to the symbol.

4.14.4 Examples

Example 1:

Define a symbol “TAPEDIR” with the value “/home/hercules/tapes”.

```
DEFSYM TAPEDIR "/home/hercules/tapes"
```

4.15 DEVPRIO (Device threads process priority)

4.15.1 Function

This value specifies the priority of the device threads.

Caution: DEVPRIO should not have a higher dispatching priority than the TOD clock and timer thread.

4.15.2 Syntax

Descriptive

DEVPRIO {8 | *nn*}

Diagram

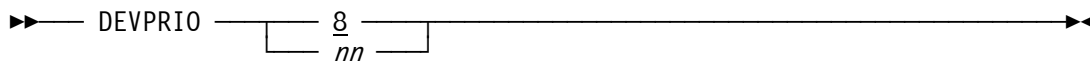

4.15.3 Parameter

nn This value specifies the priority for the device threads. For details on the priority values see section 4.57 ("Process and Thread Priorities"). The default is 8.

4.15.4 Examples

Example 1:

Set a priority of 8 for the device threads.

```
DEVPRIO 8
```

4.16 DEVTMAX (Maximum number of device threads)

4.16.1 Function

DEVTMAX specifies the maximum number of device threads allowed.

4.16.2 Syntax

Descriptive

DEVTMAX {0 | -1 | 1-*n*}

Diagram

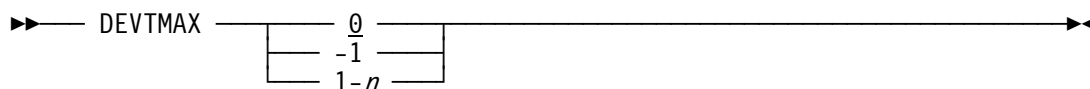

4.16.3 Parameter

0 Specify 0 to cause an unlimited number of ‘semi-permanent’ threads to be created on an ‘as-needed’ basis. This is the default. With this option, a thread is created to service an I/O request for a device if one does not already exist. When the I/O is complete the thread enters an idle state waiting for new work. If a new I/O request for the device arrives before the timeout period expires the existing thread will be reused. The timeout value is currently hard coded at 5 minutes.

Note that this option can cause one thread (or possibly more) to be created for each device in your configuration. Specifying 0 means there is no limit to the number of threads that can be created.

-1 Specify -1 to cause ‘one time only’ temporary threads to be created to service each I/O request to a device. Once the I/O request is complete, the thread exits. Subsequent I/Os to the same device will cause another worker thread to be created again.

1-n Specify a value from 1 to *n* to set an upper limit to the number of threads that can be created to service any I/O request to any device. Like the “0” option, each thread once finished servicing an I/O request enters an idle state. If a new request arrives before the timeout period expires, the thread is reused. If all threads are busy when a new I/O request arrives a new thread is created only if the specified maximum number of threads have not yet been reached. If the specified maximum number of threads already has been reached then the I/O request is placed in a queue and will be serviced by the first available thread (eg. by whichever thread becomes idle first).

This option was created to address a threading issue, possibly related to the Cygwin pthreads implementation on Windows systems. On Windows systems positive DEVTMAX values are currently not honored and are treated identically as if the value 0 had been specified. The default for non-Windows systems is 0.

4.16.4 Examples

Example 1:

Set the upper limit for the number of device threads to 16.

```
DEVTMAX 16
```

Example 2:

Allow an unlimited number of device threads.

```
DEVTMAX 0
```

4.17 DIAG8CMD (DIAGNOSE 8 command setting)

4.17.1 Function

This parameter specifies whether a command issued through Diagnose 8 will be executed by Hercules as a Hercules commands or not. An optional second argument can be specified to request whether the commands issued using the Diagnose 8 interface will be traced at the console. This may be useful for programs that routinely issue console commands using the Diagnose 8 interface.

Caution: Enabling this feature may have security consequences. When this feature is enabled it is possible for guest operating systems running under Hercules to issue commands directly to the host operating system by means of the Hercules sh (shell) command. This ability may be disabled via the SHCMDOPT statement.

4.17.2 Syntax

Descriptive

```
DIAG8CMD {DISABLE | ENABLE [ECHO | NOECHO] }
```

Diagram

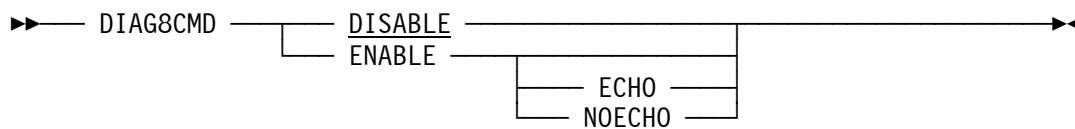

4.17.3 Parameter

- | | |
|----------------|--|
| DISABLE | Commands issued through the Diagnose 8 interface will generate a Specification Exception program interrupt on the issuing CPU. This is the default. |
| ENABLED | Commands issued through the Diagnose 8 interface will be executed by Hercules as Hercules commands. |
| ECHO | When ECHO is specified, a message is issued as the console is about to issue the command, the command is redisplayed as if it was entered through the console input line, and a final message is issued to indicate the command completed. |
| NOECHO | When NOECHO is specified, no such messages are displayed and the command completes silently, except for the output of the command itself if the Diagnose 8 interface did not request a response buffer. This is the default. |

The value of ECHO or NOECHO has no effect on command output being placed into a response buffer if the Diagnose 8 interface requested one.

4.17.4 Examples

Example 1:

Specify that commands issued through the Diagnose 8 interface are executed as Hercules commands. Additionally issue a message as the console is about to execute the command, redisplay the command itself and give a final message, indicating the command has completed.

```
DIAG8CMD ENABLE ECHO
```

4.18 ECPSVM (ECPS:VM support status (VM))

4.18.1 Function

This parameter specifies, whether ECPS:VM (Extended Control Program Support : Virtual Machine) support is to be enabled and – if it is enabled – to which level. The purpose of ECPS:VM is to provide to the VM/370 operating system a set of shortcut facilities to perform hypervisor functions (CP Assists) and virtual machine simulation (VM Assists).

Although this feature does not affect VM operating system products operating in XA, ESA or z/Architecture mode, it will affect VM/370 and VM/SP products running under VM/XA, VM/ESA or z/VM. Running VM/370 and VM/SP products under VM/XA, VM/ESA or z/VM should be done with ECPS:VM disabled. ECPS:VM should not be enabled in AP or MP environments. ECPS:VM has no effect on non-VM operating systems. It is however recommended to disable ECPS:VM when running native non-VM operating systems.

If a specific level is given this value will be reported to the operating system when it issues a Store ECPS:VM level but it does not otherwise alter the ECPS:VM facility operations. Please note that this is a partial implementation.

4.18.2 Syntax

Descriptive

ECPSVM {NO | YES | LEVEL *nn*}

Diagram

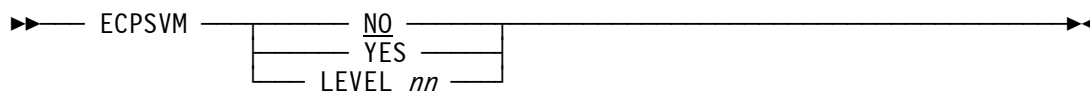

4.18.3 Parameter

- | | |
|-----------------|--|
| NO | ECPS:VM support is disabled. This is the default. |
| YES | ECPS:VM support is enabled. The support level that is reported to the operating system is set to 20. |
| LEVEL nn | ECPS:VM support is enabled. The value nn specifies the support level that is reported to the operating system. |

4.18.4 Examples

Example 1:

Enable “Extended Control Program Support : Virtual Machine” support.

```
ECPSVM YES
```

Example 2:

Enable “ECPS:VM” support and set the level reported to the operating system to 20.

```
ECPSVM LEVEL 20
```

4.19 ENGINES (Processor engine type)

4.19.1 Function

The ENGINES parameter specifies the type of engine for each installed processor. The default engine type is CP. The number of installed processor engines is determined by the MAXCPU configuration statement.

If the ENGINES configuration statement specifies more than MAXCPU engines, the excess engines are ignored. If fewer than MAXCPU engines are specified, the remaining engines are set to type CP (the default).

See the MAXCPU configuration statement for details regarding the MAX_CPU_ENGINES compile time variable.

4.19.2 Syntax

Descriptive

```
ENGINES [nn*] {CP | IL | AP | IP} [, ... ]
```

Diagram

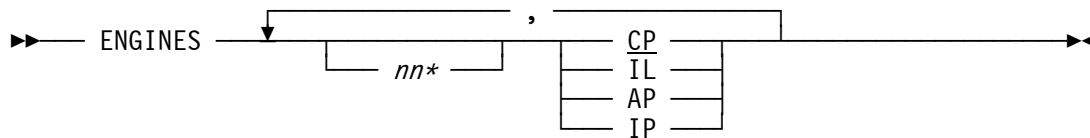

4.19.3 Parameter

- nn*** This is an optional repeat count.
- CP** Specifies a processor engine of type CP. This is the default.
- IL** Specifies a processor engine of type IL.
- AP** Specifies a processor engine of type AP.
- IP** Specifies a processor engine of type IP.

4.19.4 Examples

Example 1:

Specify 4 engines of type CP, 2 engines of type AP and 2 engines of type IP.

```
ENGINES CP,CP,CP,CP,AP,AP,IP,IP
```

or

```
ENGINES 4*CP,2*AP,2*IP
```

Example 2:

Specify 4 engines of type CP, 1 engine of type AP, 1 engine of type IP and 2 engines of type IL.

```
ENGINES CP,CP,CP,CP,AP,IP,IL,IL
```

or

```
ENGINES 4*CP,AP,IP,2*IL
```

Example 3:

Specify 3 engines of type CP and 1 engines of type IL.

```
ENGINES CP,CP,CP,IL
```

or

```
ENGINES 3*CP,IL
```

4.20 HERCLOGO (Hercules 3270 logo)

4.20.1 Function

HERCLOGO specifies the logo text file which defines a welcome screen that is presented when a TN3270 terminal connects to a Hercules 3270 device. For details on how to code the Hercules logo file see section 10 ("Hercules 3270 Logo").

4.20.2 Syntax

Descriptive

HERCLOGO *filename*

Diagram

▶— HERCLOGO — *filename* —▶

4.20.3 Parameter

filename The name of a logo text file in the current Hercules directory.

4.20.4 Examples

Example 1:

Use the logo text file "HERCLOGO.txt" for the welcome screen.

```
HERCLOGO HERCLOGO.TXT
```

4.21 HERCPRIO (Hercules process priority)

4.21.1 Function

The HERCPRIO parameter specifies the process priority for Hercules.

Caution: HERCPRIO should not have a higher dispatching priority than the TOD clock and timer thread.

4.21.2 Syntax

Descriptive

HERCPRIO {0 | *nn*}

Diagram

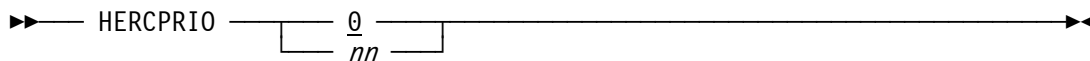

4.21.3 Parameter

nn This value specifies the process priority for Hercules. For details on the priority values see section 4.57 ("Process and Thread Priorities"). The default is 0.

4.21.4 Examples

Example 1:

Set the Hercules process priority to 0.

```
HERCPRIO 0
```

4.22 HTTPPORT (HTTP server port)

4.22.1 Function

The HTTPPORT statement specifies the port number (in decimal) on which the HTTP server will listen. If no such statement is present, the argument NONE or an invalid port number is given then the HTTP server thread will not be activated.

4.22.2 Syntax

Descriptive

```
HTTPPORT {NONE | port {NOAUTH | AUTH userid password}}
```

Diagram

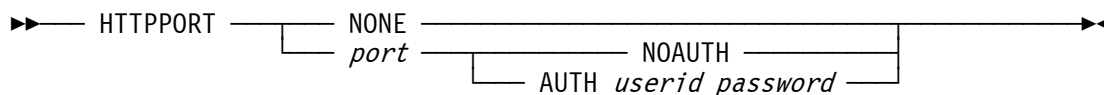

4.22.3 Parameter

- NONE** This specifies that the HTTP server is not to be started.
- port** The port number must be either 80 or within the range of 1024 to 65535 inclusive.
- NOAUTH** NOAUTH indicates that no userid and password are required to access the HTTP server.
- AUTH** AUTH indicates that a userid and a password are required to access the HTTP server. The userid and password have to be coded after the AUTH parameter.
- userid** The userid can be any valid string.
- password** The password can be any valid string.

4.22.4 Examples

Example 1:

Set the port number on which the HTTP server will listen to 8081 and specify that authorization is required to access the HTTP server. The userid should be UID0001 and the password should be PSWD0001.

```
HTTPPORT 8081 AUTH UID0001 PSWD0001
```

Example 2:

Set the port number on which the HTTP server will listen to 80 and specify that no authorization is required to access the HTTP server.

```
HTTPPORT 80 NOAUTH
```

4.23 HTTPROOT (HTTP server root directory)

4.23.1 Function

HTTPROOT specifies the full path of the root directory where the HTTP servers files reside. If this parameter is not specified the default value for Win32 builds of Hercules is the directory where the Hercules executables themselves reside. For non-Win32 builds it is the directory specified as the default package installation directory when the Hercules executables were built. This can vary depending on how the Hercules package was built, it is commonly "/usr/local/share/hercules".

4.23.2 Syntax

Descriptive

HTTPROOT *path*

Diagram

▶— HTTPROOT — *path* —▶

4.23.3 Parameter

path The full path of the root directory where the HTTP server's files reside.

4.23.4 Examples

Example 1 (for Unix installations):

Set the root directory for the HTTP servers files under a Unix system to "/usr/local/share/hercules".

```
HTTPROOT /usr/local/share/hercules
```

Example 2 (for Windows installations):

Set the root directory for the HTTP servers files under a Windows system to "D:/HERCULES/HTML".

```
HTTPROOT D:/HERCULES/HTML
```

4.24 IGNORE (Ignore subsequent INCLUDE errors)

4.24.1 Function

This system parameter indicates that errors caused by subsequent INCLUDE statements - for files which do not exist - should be ignored rather than causing the Hercules startup to be aborted as it would otherwise normally occur

4.24.2 Syntax

Descriptive

IGNORE INCLUDE_ERRORS

Diagram

▶▶ — IGNORE — INCLUDE_ERRORS —————▶▶

4.24.3 Parameter

INCLUDE_ERRORS Indicates that subsequent INCLUDE errors will be ignored.

4.24.4 Examples

Example 1:

Specify that errors caused by subsequent INCLUDE statements should be ignored.

```
IGNORE INCLUDE_ERRORS
```

4.25 INCLUDE (Include configuration file)

4.25.1 Function

An INCLUDE statement instructs the Hercules initialisation process to treat the contents of the file specified by filepath as if its contents had appeared in the configuration file at the point where the INLCUDE statement appears.

The included file itself may contain yet another INCLUDE statement as long as the maximum nesting depth of 8 is not exceeded.

4.25.2 Syntax

Descriptive

INCLUDE *filepath*

Diagram

▶— INCLUDE — *filepath* —————▶

4.25.3 Parameter

filepath Specifies the path and the filename of the configuration file that is to be included.

4.25.4 Examples

Example 1:

Specify that Hercules should include the contents of the file "D:\S390\CONF\CONFIG2.CONF" into the configuration.

```
INCLUDE D:\S390\CONF\CONFIG2.CONF
```

4.26 IODELAY (I/O interrupt wait time (LINUX))

4.26.1 Function

IODELAY sets the amount of time in microseconds to wait after an I/O interrupt is ready to be set pending. This value can also be set using the Hercules console. The purpose of this parameter is to circumvent a bug in the Linux/390 and z/Linux dasd.c device driver. The bug is more likely to occur under Hercules than on a real machine as Hercules may present an I/O interrupt sooner than a real machine.

NOTE : OSTAILOR LINUX no longer sets IODELAY to 800 since the problem described above is no longer present in recent versions of the linux kernel.

4.26.2 Syntax

Descriptive

IODELAY {0 | *usecs* [NOWARN]}

Diagram

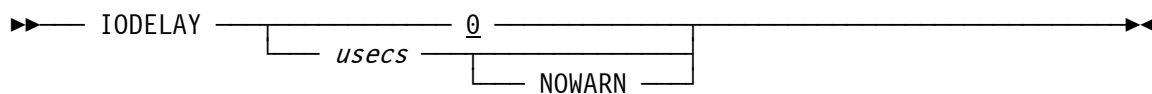

4.26.3 Parameter

usecs Amount of time in microseconds to wait after an I/O interrupt is ready to be set pending.

NOWARN If the IODELAY value is non-zero a warning message (HHCCF037W) will be issued unless NOWARN is specified.

4.26.4 Examples

Example 1:

Set the amount of time to wait after an I/O interrupt is ready to be set pending to 1000 microseconds.

```
IODELAY 1000
```

Example 2:

Set the amount of time to wait after an I/O interrupt is ready to be set pending to 500 microseconds and suppress the warning message HHCCF037W.

```
IODELAY 500 NOWARN
```

4.27 LDMOD (Additional dynamic load modules)

4.27.1 Function

LDMOD provides the capability of defining additional modules that will be loaded by the Hercules Dynamic Loader. The default search order is within the Hercules directory and in the default DLL search path. Most systems also support absolute filenames (eg. Names starting with "/" or ".") in which case the default search path is not taken. Multiple LDMOD statements may be used.

4.27.2 Syntax

Descriptive

LDMOD *module module module ...*

Diagram

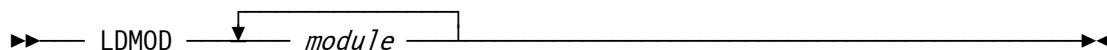

4.27.3 Parameter

module A list of modules that are to be loaded by the Hercules Dynamic Loader.

4.27.4 Examples

Example 1:

Instruct Hercules to load the additional modules named MODULE01, MODULE02 and MODULE03 from the Hercules directory or the default DLL search path.

```
LDMOD MODULE01 MODULE02 MODULE03
```

4.28 LEGACYSENSEID (SENSE ID CCW (x'E4') feature)

4.28.1 Function

This option specifies whether the SENSE ID CCW (X'E4') will be honored for the devices that originally did not support that feature. This includes (but may not be limited to) 3410 and 3420 tape drives, 2311 and 2314 direct access storage devices and 2703 communication controllers. Because those legacy devices didn't originally support this command, and for compatibility reasons, the default is OFF or DISABLE.

Specify ON or ENABLE if your guest operating system needs the Sense ID support to dynamically detect those devices. Note that most current operating systems will not detect those devices even though Sense ID is enabled because those devices never supported the Sense ID in the first place. This mainly applies to custom built or modified versions of guest operating systems that are aware of this specific Hercules capability.

4.28.2 Syntax

Descriptive

```
LEGACYSENSEID [{OFF | DISABLE} | {ON | ENABLE}]
```

Diagram

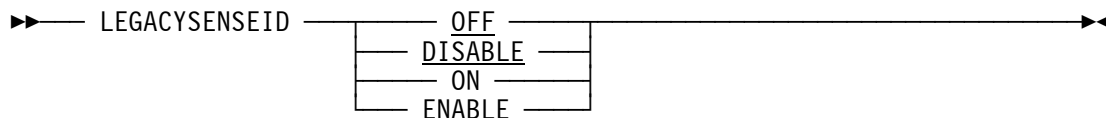

4.28.3 Parameter

OFF or DISABLE Specify OFF or DISABLE if your guest operating system does not need the Sense ID support to dynamically detect devices that originally did not support that feature. This is the default.

ON or ENABLE Specify ON or ENABLE if your guest operating system needs the Sense ID support to dynamically detect devices that originally did not support that feature.

4.28.4 Examples

Example 1:

Specify that the SENSE ID CCW will be honored for devices that originally did not support that feature.

```
LEGACYSENSEID ENABLE
```

4.29 LOADPARAM (IPL parameter)

4.29.1 Function

This parameter specifies the eight-character IPL parameter which is used by all MVS based operating systems (MVS 3.8J, MVS/SP, MVS/XA, MVS/ESA, OS/390, z/OS, ...) to select the system start parameter.

4.29.2 Syntax

Descriptive

LOADPARAM *iplparm*

Diagram

▶— LOADPARAM — *iplparm* —▶

4.29.3 Parameter

iplparm The system parameter used for the IPL of the intended operating system. The parameter is operating system dependent, consult the relevant operating system documentation for details.

4.29.4 Examples

Example 1:

Use 0A8200M1 as system parameter for the IPL of the operating system.

```
LOADPARAM 0A8200M1
```

4.30 LOGOPT (Log options)

4.30.1 Function

The LOGOPT statement specifies the Hercules log options. It allows to insert or suppress the time stamp in front of each log message

4.30.2 Syntax

Descriptive

```
LOGOPT {TIMESTAMP | TIME | NOTIMESTAMP | NOTIME}
```

Diagram

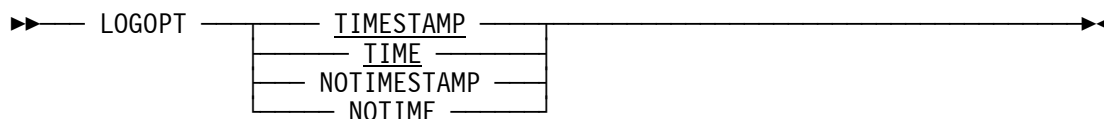

4.30.3 Parameter

TIMESTAMP	Insert a time stamp in front of each log message. This is the same as using TIME.
NOTIMESTAMP	Display log messages without a timestamp. This is the same as using NOTIME.
TIME	Insert a time stamp in front of each log message. This is the same as using TIMESTAMP.
NOTIME	Display log messages without a timestamp. This is the same as using NOTIMESTAMP.

4.30.4 Examples

Example 1:

Specify that messages in the log are to be time stamped.

```
LOGOPT TIMESTAMP
```

4.31 LPARNAME (LPAR name returned by DIAG x'204')

4.31.1 Function

LPARNAME defines the LPAR name returned by DIAG x'204'.

4.31.2 Syntax

Descriptive

LPARNAME {HERCULES | *lparname*}

Diagram

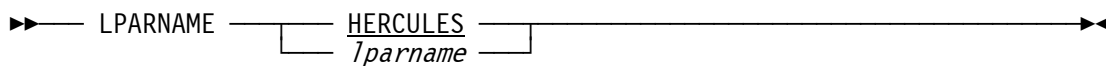

4.31.3 Parameter

lparname Maximum 8 byte character name for the LPAR. The default is HERCULES.

4.31.4 Examples

Example 1:

Specify HERCULES as LPAR name returned by DIAG x'204'.

```
LPARNAME HERCULES
```

4.32 LPARNUM (LPAR identification number)

4.32.1 Function

The LPARNUM configuration statement sets the LPAR identification number. It can be one or two hexadecimal digits. If one digit is specified then STIDP stores a format-0 CPU ID containing the logical CPU number, the LPAR number, and the last four digits of the CPU serial number. If two digits are specified then STIDP stores a format-1 CPU ID containing the two-digit LPAR identifier followed by the last four digits of the CPU serial number.

If LPARNUM is not specified in the configuration file then STIDP returns a CPUID as before, where the leftmost digit of the serial number is replaced by the logical CPU number if the serial number begins with a zero.

4.32.2 Syntax

Descriptive

LPARNUM {00 | *nn*}

Diagram

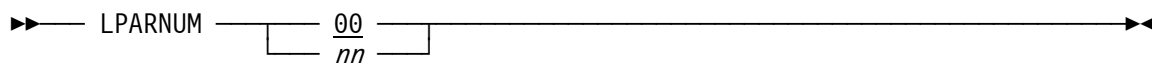

4.32.3 Parameter

xx Specifies the one- or two-digit hexadecimal LPAR identification number stored by the STIDP instruction. If a one-digit number is specified then STIDP stores a format-0 CPU ID. If a two-digit number is specified then STIDP stores a format-1 CPU-ID.

4.32.4 Examples

Example 1:

Set the LPAR identification number to x'21' (Format-1 CPU-ID).

```
LPARNUM 21
```

Example 2:

Set the LPAR identification number to x'A' (Format-0 CPU-ID).

```
LPARNUM A
```

4.33 MAINSIZE (Main storage in MB)

4.33.1 Function

Specifies the size of the main storage in megabytes. The actual upper limit of the main storage is determined by the host system's architecture, operating system, and on some systems the amount of physical memory and paging space you have available. The value must not exceed 4095 (almost 4GB) for 32-bit platforms and 4,294,967,295 (about 4 million GB) for 64-bit platforms.

The practical limit depends on the maximum amount of storage that can be obtained by malloc (usually around 1 GB on 32-bit platforms; on 64-bit platforms the value should only be limited by available paging space).

4.33.2 Syntax

Descriptive

MAINSIZE *size*

Diagram

▶— MAINSIZE — *size* —▶

4.33.3 Parameter

size A valid decimal number whose value is at least 2. The upper limit must not exceed 4095 (almost 4GB) for 32-bit platforms and 4,294,967,295 (about 4 million GB) for 64-bit platforms.

4.33.4 Examples

Example 1:

Set the size of the main storage to 64 MB.

```
MAINSIZE 64
```

Example 1:

Set the size of the main storage to 4 GB.

```
MAINSIZE 4096
```

4.34 MANUFACTURER (Manufacturer name returned by STSI instruction)

4.34.1 Function

MANUFACTURER specifies the manufacturer name returned by the STSI instruction. The default name is HRC.

4.34.2 Syntax

Descriptive

MANUFACTURER {HRC | *name*}

Diagram

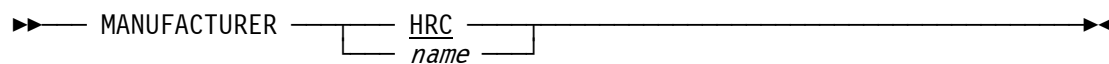

4.34.3 Parameter

name Any name with a maximum length of four characters. If MANUFACTURER is not specified in the configuration file then the default name is HRC.

4.34.4 Examples

Example 1:

Set the manufacturer name returned by the STSI instruction to "HERC".

```
MANUFACTURER HERC
```

4.35 MAXCPU (Maximum number of CPUs)

4.35.1 Function

The MAXCPU configuration statement specifies the maximum number of installed processor engines. The NUMCPU statement specifies the number of engines which will be configured online at startup time. All processors are CP engines unless otherwise specified by the ENGINES statement.

MAX_CPU_ENGINES is a compile-time variable which sets an upper limit on the value of MAXCPU. The value of MAX_CPU_ENGINES is displayed in the build information message on the Hercules control panel at startup time. To change the value of MAX_CPU_ENGINES you must rebuild Hercules. For Unix builds, specify `./configure --enable-multi-cpu=nn` before performing make. For Windows builds, specify `"SET MAX_CPU_ENGINES=nn"` before performing nmake.

MAX_CPU_ENGINES cannot exceed 64. For performance reasons, values above 32 are not recommended for 32-bit platforms. If MAX_CPU_ENGINES is set to 1 then multiprocessing is disabled. See also the NUMCPU statement for a discussion of the performance implications of MAX_CPU_ENGINES.

The value of MAXCPU can not exceed the value of MAX_CPU_ENGINES. If MAXCPU is not specified then the default value is the value of MAX_CPU_ENGINES.

4.35.2 Syntax

Descriptive

MAXCPU { 1 | *nn* }

Diagram

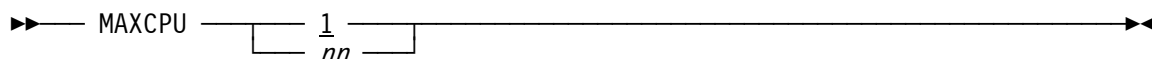

4.35.3 Parameter

nn Specifies the maximum number of installed processor engines. The value of MAXCPU can not exceed the value of MAX_CPU_ENGINES. If MAXCPU is not specified in the configuration file then the default value is the value of MAX_CPU_ENGINES.

4.35.4 Examples

Example 1:

Set the maximum number of installed processor engines to 8.

```
MAXCPU 8
```

4.36 MODEL (Model names returned by STSI instruction)

4.36.1 Function

MODEL specifies the model names returned by the STSI instruction. If two operands are supplied, the first is the hardware model name (CPC ND model) and the second is the capacity model name (CPC SI model).

If only one operand is supplied, it is used as both the hardware model name and the capacity model name. The optional third and fourth operands specify the permanent capacity model name and the temporary capacity model name respectively. The default model name is EMULATOR.

4.36.2 Syntax

Descriptive

```
MODEL {EMULATOR | hardware_model} [capacity_model]  
      [perm_capacity_model] [temp_capacity_model]
```

Diagram

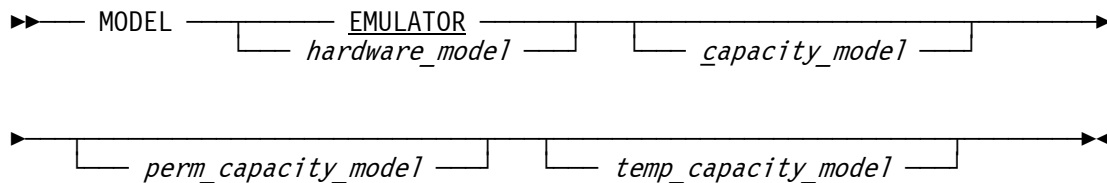

4.36.3 Parameter

hardware_model This specifies the hardware model name. This can be any name with a maximum length of 16 characters. If the MODEL system parameter is not specified in the configuration file then the default name is EMULATOR.

capacity_model This specifies the capacity model name. If this parameter is omitted the hardware_model name is used as capacity_model name.

perm_capacity_model This optional parameter specifies the permanent capacity model name.

temp_capacity_model This optional parameter specifies the temporary capacity model name.

4.36.4 Examples

Example 1:

Set the model name returned by the STSI instruction to “EMULATOR”.

```
MODEL EMULATOR
```

4.37 MODPATH (Dynamic load module path)

4.37.1 Function

MODPATH specifies the path where dynamic load modules are loaded from. If a MODPATH statement is coded then the path on the MODPATH statement is searched before the default path is searched. When a relative path is specified it is interpreted as a relative path within the default search path. If an absolute path is coded it is interpreted as such.

The default MODPATH is "hercules" which means modules are loaded from the directory hercules within the default LD_LIBRARY_PATH.

4.37.2 Syntax

Descriptive

MODPATH *path*

Diagram

▶— MODPATH — *path* —————▶

4.37.3 Parameter

path Path where dynamic load modules are loaded from.

4.37.4 Examples

Example 1:

Set the path from where dynamic load modules are loaded to "D:/HERCULES/MODIFICATIONS".

```
MODPATH D:/HERCULES/MODIFICATIONS
```

4.38 MOUNTED_TAPE_REINIT (Control tape initialization)

4.38.1 Function

This system parameter specifies whether reinitialization of tape drive devices via the DEVINIT command in order to mount a new tape should be allowed if there is already a tape mounted on the drive. This option is meant as a safety mechanism to protect against accidentally unmounting a tape from the wrong device as a result of a simple typing error and thereby eventually cancelling a potentially important tape job. Please note that for SCSI tape drives the "DEVINIT nnnn *" command has no effect. The tape must be unmounted manually since it is a real physical device and not emulated via a disk file like '.AWS' or '.HET' tapes.

Specifying ALLOW, the default, indicates that new tapes may be mounted via "DEVINIT nnnn new-tape-filename" irrespective of whether or not there is already a tape mounted on the drive.

Specifying DISALLOW prevents new tapes from being mounted if one is already mounted. Before the new tape can be mounted the existing one has first to be unmounted (via the "DEVINIT nnnn *" command). Otherwise the DEVINIT attempt to mount the new tape is rejected.

4.38.2 Syntax

Descriptive

```
MOUNTED_TAPE_REINIT {ALLOW | DISALLOW}
```

Diagram

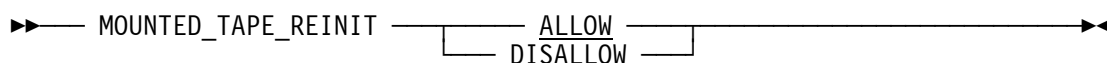

4.38.3 Parameter

ALLOW Indicates that new tapes may be mounted irrespective of whether or not there is already a tape mounted on the drive. This is the default.

DISALLOW Prevents new tapes from being mounted if one is already mounted on the drive. Before the new tape can be mounted the currently mounted tape must first to be unmounted.

4.38.4 Examples

Example 1:

Specify that new tapes are not being mounted if one is already mounted on the drive.

```
MOUNTED_TAPE_REINIT DISALLOW
```

4.39 NUMCPU (Number of emulated CPUs)

4.39.1 Function

NUMCPU specifies the number of emulated processor engines which will be configured online at startup time. All processors are CP engines unless otherwise specified by the ENGINES configuration statement. NUMCPU can not exceed the value of the MAXCPU configuration statement. If NUMCPU is less than MAXCPU then the remaining engines can be configured online later.

Multiprocessor emulation works best if your host system actually has more than one physical CPU, but you can still emulate multiple CPUs nevertheless even on a uniprocessor system (and you might even achieve a small performance benefit when you do). There is little point, however, in specifying NUMCPU greater than 1 unless your guest operating system (running under Hercules) is actually able to support multiple CPUs.

If you do not actually need multiprocessor emulation, then setting MAX_CPU_ENGINES to 1 at compile time might even produce a slight performance advantage too.

4.39.2 Syntax

Descriptive

NUMCPU {1 | *nn*}

Diagram

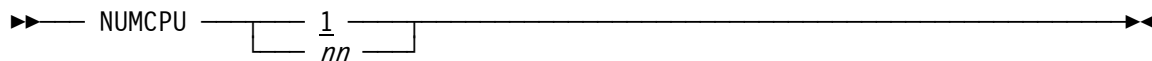

4.39.3 Parameter

number The number of emulated CPUs. NUMCPU can not exceed the value of the MAXCPU configuration statement. If NUMCPU is less than MAXCPU then the remaining engines can be configured online later.

4.39.4 Examples

Example 1:

Set the number of emulated CPUs to 4.

```
NUMCPU 4
```

4.40 NUMVEC (Number of vector facilities)

4.40.1 Function

NUMVEC defines the number of emulated vector facilities. Default is one per CPU (see also the NUMCPU parameter). The vector facility is only available in ESA/390 mode by default.

4.40.2 Syntax

Descriptive

NUMVEC {0 | *nn*}

Diagram

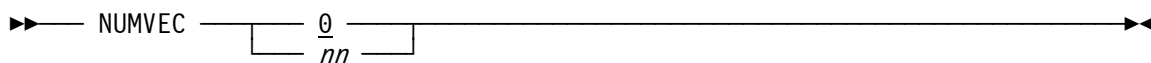

4.40.3 Parameter

number The number of desired vector facilities.

4.40.4 Examples

Example 1:

Set the number of emulated vector facilities to 1.

NUMVEC 1

4.41 OSTAILOR (Intended operating system)

4.41.1 Function

OSTAILOR lets you specify the intended operating system. The effect of this parameter is to reduce control panel message traffic by selectively suppressing trace messages for program checks which are considered normal in the specified environment. If this statement is omitted exception messages for program checks 10, 11, 16, and 1C are suppressed.

The argument *QUIET* suppresses all exception messages whereas the argument *NULL* suppresses none of them. The other options do suppress some messages and do not suppress other messages depending on the specified operating system.

See also the PGMTRACE command which allows to further fine tune the tracing of program interrupt exceptions.

4.41.2 Syntax

Descriptive

OSTAILOR {z/OS | OS/390 | VM | VSE | LINUX | OpenSolaris | QUIET | NULL}

Diagram

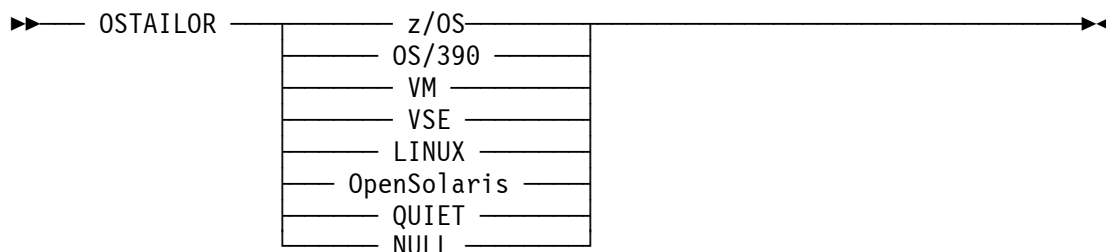

4.41.3 Parameter

z/OS	Code z/OS if you intend to run z/OS.
OS/390	Code OS/390 if you intend to run MVS/370, MVS/XA, MVS/ESA, OS/390.
VM	Code VM if you intend to run VM/370, VM/ESA or z/VM.
VSE	Code VSE if you intend to run VSE/370, VSE/ESA or z/VSE.
LINUX	Code Linux you intend to run Linux/390 or Linux for z/Series.
OpenSolaris	Code OpenSolaris you intend to run OpenSolaris for z/Series.
QUIET	QUIET discards all exception messages.
NULL	NULL allows all exception messages to be logged.

4.41.4 Examples

Example 1:

Specify Linux as the intended operating system and selectively suppressing trace messages for program checks which are considered normal in the Linux environment.

```
OSTAILOR LINUX
```

Example 2:

Do not specify the intended operating system and allow all exception messages to be logged.

```
OSTAILOR NULL
```

4.42 PANRATE (Panel refresh rate)

4.42.1 Function

PANRATE defines the rate, in milliseconds, at which the Hercules hardware console (HMC) will be refreshed. Please be aware that the panel refresh rate can reduce overall Hercules performance if PANRATE is set to fast.

4.42.2 Syntax

Descriptive

PANRATE {SLOW | FAST | *rate*}

Diagram

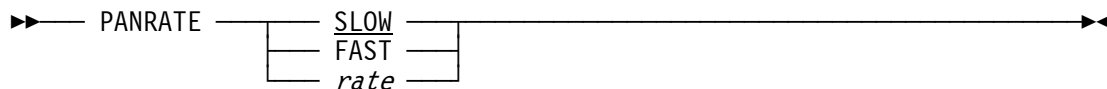

4.42.3 Parameter

- SLOW** SLOW is a synonym for a Hercules hardware console refresh rate of 500 milliseconds. This is also the default, if PANRATE is not specified.
- FAST** FAST is a synonym for a Hercules hardware console refresh rate of 50 milliseconds.
- rate** Any value between 1 (10) and 5000 milliseconds. A value less than the Linux system clock tick interval (10 on Intel platforms, 1 on Alpha platforms) or a value of more than 5000 will be rejected.

4.42.4 Examples

Example 1:

Set the panel refresh rate to 1 second.

```
PANRATE 1000
```

Example 2:

Set the panel refresh rate to 50 milliseconds.

```
PANRATE FAST
```

4.43 PANTITLE (Hercules console window title)

4.43.1 Function

PANTITLE specifies an optional console window title-bar string to be used in place of the default supplied by the windowing system. This option allows one to distinguish between different Hercules sessions when running more than one instance of Hercules on the same machine.

The option takes effect only when the Hercules console is displayed on an xterm terminal (commonly used on Unix systems) or in a Windows command prompt window. Note that this option has no effect when Hercules is run under the control of the Hercules Windows GUI since Hercules's console window is hidden in favour of using the GUI's window instead.

4.43.2 Syntax

Descriptive

```
PANTITLE {text | "text text text"}
```

Diagram

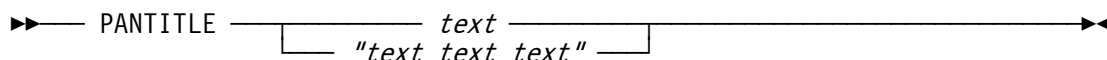

4.43.3 Parameter

text Specifies the optional console window title-bar string to be used. If the value contains any blanks it must be enclosed within double-quotes (").

4.43.4 Examples

Example 1:

Set the console window title-bar string to "Hercules Emulator HMC".

```
PANTITLE "Hercules Emulator HMC"
```

Example 2:

Set the console window title-bar string to "Hercules".

```
PANTITLE Hercules
```

4.44 PGMPRDOS (LPP license setting)

4.44.1 Function

PGMPRDOS specifies whether or not Hercules will run licensed program product (LPP) ESA or z/Architecture operating systems.

4.44.2 Syntax

Descriptive

PGMPRDOS {RESTRICTED | LICENSED}

Diagram

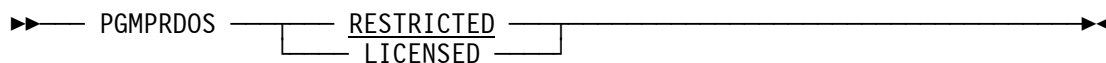

4.44.3 Parameter

RESTRICTED When PGMPRDOS is set to RESTRICTED, Hercules will stop all CPUs when a licensed program product operating systems is detected. RESTRICTED is the default.

LICENSED Setting PGMPRDOS to LICENSED will allow you to run licensed program product operating systems normally. This parameter has no effect on Linux/390, Linux for z/Series, or any 370-mode operating system. If you are running Hercules under the Windows GUI a pop up window appears during startup which must be acknowledged before the startup continuous.

4.44.4 Examples

Example 1:

Allow licensed program product operating systems to run normally.

```
PGMPRDOS LICENSED
```

Example 2:

Disallow licensed program product operating systems to run.

```
PGMPRDOS RESTRICTED
```

4.45 PLANT (Plant name returned by STSI instruction)

4.45.1 Function

PLANT specifies the plant name returned by the STSI instruction. The default plant name is ZZ.

4.45.2 Syntax

Descriptive

PLANT {ZZ | *name*}

Diagram

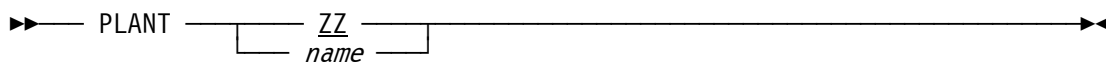

4.45.3 Parameter

name Any name with a maximum length of four characters. If the PLANT system parameter is not specified in the configuration file then the default name is ZZ.

4.45.4 Examples

Example 1:

Specify "HERC" as the plant name returned by the STSI instruction.

```
PLANT HERC
```

4.46 SCLPROOT (SCLP base directory)

4.46.1 Function

The SCLPROOT configuration statement sets the SCLP base directory. If a directory is given then SCLP disk I/O for the specified directory path is enabled. NONE disables SCLP disk I/O.

A subsequent list-directed IPL resets the path to the location of the .ins file, and a subsequent CCW-type IPL disables SCLP disk I/O.

4.46.2 Syntax

Descriptive

```
SCLPROOT {NONE | directory}
```

Diagram

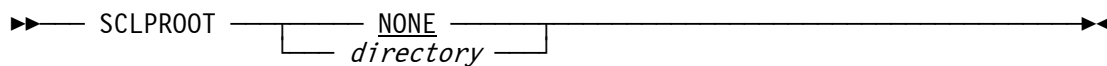

4.46.3 Parameter

NONE Disables SCLP disk I/O.

directory Specifies the directory from which SCLP disk I/O is allowed. A subsequent IPL of an .ins file or a subsequent CCW-type IPL will override this.

4.46.4 Examples

Example 1:

Disable SCLP disk I/O.

```
SCLPROOT NONE
```

Example 2:

Specifies "D:\SCLP\DISK" as the directory from which SCLP disk I/O is allowed.

```
SCLPROOT D:\SCLP\DISK
```

4.47 SHCMDOPT (Shell command option)

4.47.1 Function

This statement defines the behaviour of the shell (sh) command.

4.47.2 Syntax

Descriptive

```
SHCMDOPT {DISABLE | NODIAG8}
```

Diagram

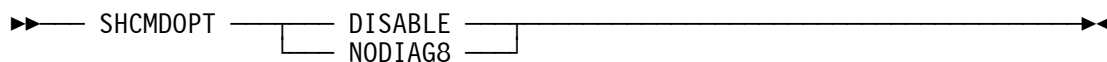

4.47.3 Parameter

DISABLE When set to `DISABLE`, `sh` (shell) commands are globally disabled and will result in an error if entered either directly via the Hercules hardware console or programmatically via the `DIAG8CMD` interface.

NODIAG8 When set to `NODIAG8` only the programmatic execution of shell commands via the the diagnose 8 interface is disabled; `sh` (shell) commands entered directly via the Hercules hardware console will still work.

NOTE: "entered directly via the Hercules hardware console" includes commands entered via the HTTP server facility or entered via `.rc "run command"` scripts.

4.47.4 Examples

Example 1:

Disable the programmatic execution of shell commands via the the diagnose 8 interface but allow shell commands entered directly via the Hercules hardware console.

```
SHCMDOPT NODIAG8
```

Example 2:

Globally disable execution of shell commands.

```
SHCMDOPT DISABLE
```

4.48 SHRDPOR (Shared device server port)

4.48.1 Function

SHRDPOR defines the port number (in decimal) on which the Shared Device Server will listen. The Shared Device Server will allow other Hercules instances to access devices on this instance. Currently only DASD devices may be shared. The default port is 3990. If you decide to use a different port number then you must specify this port number on the device statements for the other Hercules instances. If no SHRDPOR statement is present then the Shared Device Server thread will not be activated.

4.48.2 Syntax

Descriptive

```
SHRDPOR {3990 | port}
```

Diagram

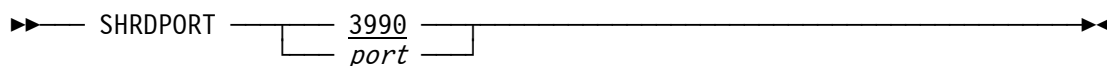

4.48.3 Parameter

3990 This is the default port for the Shared Device Server. If this port number is used then the port number is not required to be coded on the device statements for other Hercules instances.

port Any valid port number.

4.48.4 Examples

Example 1:

Specify 3990 as the port used for the Shared Device Server.

```
SHRDPOR 3990
```

4.49 SYSEPOCH (Base date for TOD clock)

4.49.1 Function

Specifies the base date for the TOD clock. Use the default value (1900) for all systems except OS/360. Use 1960 for OS/360. Values other than these were formerly used to offset the TOD clock by a number of years to move the date before the year 2000 for non-Y2K-compliant operating systems. This use is deprecated and support will be removed in a future release after which only values of 1900 or 1960 will be accepted.

4.49.2 Syntax

Descriptive

SYSEPOCH {1900 | 1960 | *year* [*+years* | *-years*] }

Diagram

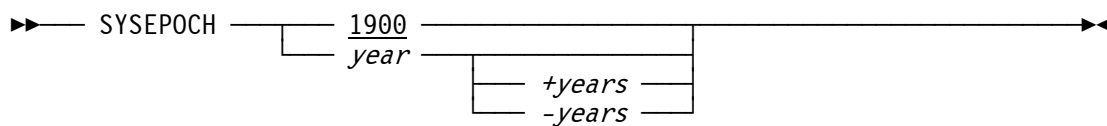

4.49.3 Parameter

- year** This is the base date for the TOD clock. The only supported values for SYSEPOCH are currently 1900 and 1960. Any other value will produce a warning message showing the equivalent values to specify in the SYSEPOCH statement. 1900 is the default.
- +/- years** An optional year offset may be specified and will be treated as though it had been specified using the YROFFSET statement.

4.49.4 Examples

Example 1:

Specify year 1900 as the base date for the TOD clock.

```
SYSEPOCH 1900
```

4.50 TIMERINT (Internal timer update interval)

4.50.1 Function

The TIMERINT parameter sets the internal timer update interval in microseconds. This parameter specifies how frequently Hercules's internal timers-update thread updates the TOD clock, CPU Timer and other architectural related clock/timer values.

The default interval is 50 microseconds which strikes a reasonable balance between clock accuracy and overall host performance. The minimum allowed value is 1 microsecond and the maximum is 1,000,000 microseconds (one second).

CAUTION: While a lower TIMERINT value may help increase the accuracy of the guest's TOD clock and CPU Timer values it could also have severe negative impact on the overall performance of the host operating system. This is especially true when a low TIMERINT value is coupled with a high HERCPRIO and TODPRIO priority setting. Exercise extreme caution when choosing your desired TIMERINT in relationship to your chosen HERCPRIO and TODPRIO priority settings.

4.50.2 Syntax

Descriptive

```
TIMERINT {50 | interval}
```

Diagram

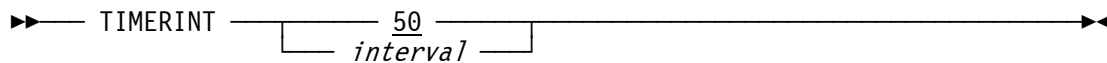

4.50.3 Parameter

interval Specifies the timer update interval in microseconds. The minimum allowed value for the interval is 1 microsecond and the maximum is 1,000,000 microseconds (one second).

4.50.4 Examples

Example 1:

Set the timer update interval to 100 microseconds.

```
TIMERINT 100
```

4.51 TODDRAG (TOD clock drag factor)

4.51.1 Function

TODDRAG specifies the TOD clock drag factor. This parameter can be used to slow down or speed up the TOD clock by a factor of *nn*. A significant slowdown can improve the performance of some operating systems which consume significant amounts of CPU time processing timer interrupts. A drag factor of 2.0 slows down the clock by 50%, a drag factor of 0.5 doubles the speed of the clock, a drag factor of 1.01 slows down the clock by 1% and 0.99 speeds up the clock by 1%.

4.51.2 Syntax

Descriptive

```
TODDRAG {1.000000 | factor}
```

Diagram

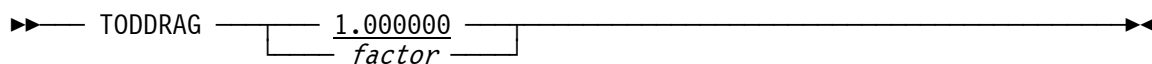

4.51.3 Parameter

factor The factor by which the TOD clock will be slowed down or sped up. The default factor is 1.000000.

4.51.4 Examples

Example 1:

Slow down the TOD clock by 50%.

```
TODDRAG 2
```

Example 2:

Double the speed of the TOD clock.

```
TODDRAG 0.5
```

4.52 TODPRIO (Timer thread process priority)

4.52.1 Function

With this parameter you can specify the priority of the TOD clock and the timer threads.

Caution: TODPRIO should be given a dispatching priority equal to or higher than any other thread (CPUPRIO, DEVPRIO, HERCPRIO) within Hercules.

4.52.2 Syntax

Descriptive

TODPRIO {-20 | *nn*}

Diagram

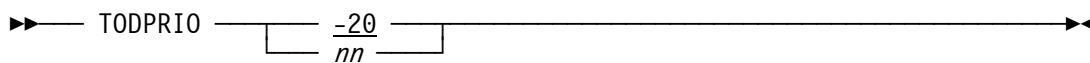

4.52.3 Parameter

nn This value specifies the priority of the TOD clock and the timer thread. For details on the priority values see section 4.57 ("Process and Thread Priorities"). The default for TODPRIO is -20.

4.52.4 Examples

Example 1:

Set the priority of the TOD clock and the timer threads to -20.

```
TODPRIO -20
```

4.53 TRACEOPT (Instruction trace display option)

4.53.1 Function

TRACEOPT sets the Hercules instruction tracing display option. In addition to the TRACEOPT configuration file statement there is also a corresponding TRACEOPT console command to dynamically display and/or update the current setting at any time.

4.53.2 Syntax

Descriptive

```
TRACEOPT {TRADITIONAL | REGSFIRST | NOREGS}
```

Diagram

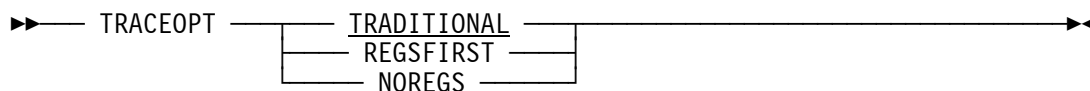

4.53.3 Parameter

TRADITIONAL TRADITIONAL (the default), displays the registers following the instruction about to be executed such that pressing enter (to execute the displayed instruction) then shows the next instruction to be executed followed by the updated registers display.

REGSFIRST REGSFIRST displays the current register contents followed by the instruction about to be executed such that pressing enter (to execute the displayed instruction) then shows the updated registers followed by the next instruction to be executed.

NOREGS NOREGS suppresses the registers display altogether and shows just the instruction to be executed.

4.53.4 Examples

Example 1:

Set the tracing display option to display the registers following the instruction about to be executed.

```
TRACEOPT TRADITIONAL
```

4.54 TZOFFSET (TOD clock offset from GMT)

4.54.1 Function

TZOFFSET is used to define the offset of the TOD clock from the current system time. For GMT use the default value (0000). For timezones west of Greenwich specify a negative value (example: -0500 for US Eastern Standard Time, -0800 for US Pacific Standard Time). For timezones east of Greenwich, specify a positive value (example: +0100 for Central European Time, +0930 for South Australian Time).

4.54.2 Syntax

Descriptive

TZOFFSET {0000 | +hhmm | -hhmm}

Diagram

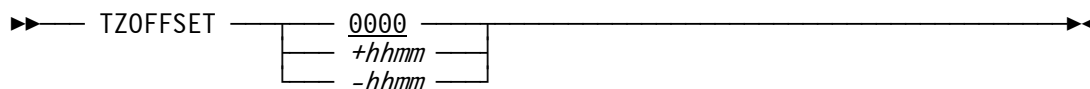

4.54.3 Parameter

- 0000** GMT time (0000 is the default value). Please note that this is also the correct setting if your system time (the time of the operating system on which Hercules is running) is set to local time rather than GMT.
- +hhmm** Use a positive time in hours and minutes for timezones east of Greenwich.
- hhmm** Use a negative time in hours and minutes for timezones west of Greenwich.

4.54.4 Examples

Example 1:

Set the offset of the TOD clock from the current system time to Central European Time.

```
TZOFFSET +0100
```

4.55 XPNDSize (Expanded storage in MB)

4.55.1 Function

Specifies the expanded storage size in megabytes.

4.55.2 Syntax

Descriptive

XPNDSize *size*

Diagram

▶— XPNDSize — *size* —▶

4.55.3 Parameter

nnnnnnn A decimal number in the range of 0 to 16777215. The actual upper limit is determined by your host system's architecture and operating system and on some systems the amount of physical memory and paging space you have available.

4.55.4 Examples

Example 1:

Set the size of the expanded storage to 256 MB.

```
XPNDSize 256
```

Example 2:

Set the size of the expanded storage to 2 GB.

```
XPNDSize 2048
```

4.56 YROFFSET (TOD clock offset from actual date)

4.56.1 Function

Specifies a number of years to offset the TOD clock from the actual date. Positive numbers will move the clock forward in time while negative numbers will move it backward. A common value for non-Y2K-compliant operating systems is YROFFSET -28 which has the advantage that the day of the week and the presence or absence of February 29 is the same as the current year.

4.56.2 Syntax

Descriptive

YROFFSET { *+years* | *-years* }

Diagram

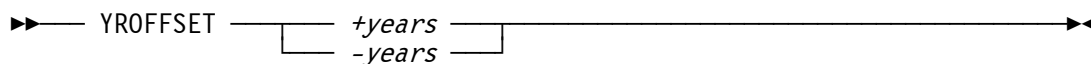

4.56.3 Parameter

+/-years Years specifies a number of years to offset the TOD clock from the actual date. This value may not be specified as greater than ± 142 years, the total range of the TOD clock. Specifying a value that causes the computed TOD clock year to be earlier than the value of SYSEPOCH or more than 142 years later than SYSEPOCH will produce unexpected results.

4.56.4 Examples

Example 1:

Specify 28 years to offset the TOD clock from the actual date.

```
YROFFSET    -28
```

4.57 Process and Thread Priorities

This section covers details regarding the priority settings within Hercules. The relevant system parameters are:

- CPUPRIO
- DEVPRIO
- HERCPRIO
- TODPRIO

4.57.1 Process Priorities

Under Linux a process is a thread and thread priority information applies instead.

For Windows the following conversions are used for translating Unix process priorities to Windows priority classes:

Unix Process Priority	Windows Priority Class	Meaning
-20 to -16	Realtime	Process that has the highest possible priority. The threads of the process preempt the threads of all other processes, including operating system processes performing important tasks. For example, a real-time process that executes for more than a very brief interval can cause disk caches not to flush or cause the mouse to be unresponsive.
-15 to -9	High	Process that performs time-critical tasks that must be executed immediately. The threads of the process preempt the threads of normal or idle priority class processes. An example is the Task List, which must respond quickly when called by the user, regardless of the load on the operating system. Use extreme care when using the high-priority class, because a high-priority class application can use nearly all available CPU time.
-8 to -1	Above Normal	Process that has priority above the Normal class but below the High class.
0 to 7	Normal	Process with no special scheduling needs.
8 to 15	Below Normal	Process that has priority above the Idle class but below the Normal class.
16 to 20	Low	Process whose threads run only when the system is idle. The threads of the process are preempted by the threads of any process running in a higher priority class. An example is a screen saver. The idle-priority class is inherited by child processes.

Table 4: Process Priority Conversions

Caution: On Windows, the value you choose for your Process Priority has a direct impact on how your Thread Priorities are interpreted! You should never modify one without understanding what impact your doing so might have on the other!

4.57.2 Thread Priorities

On Linux/Unix hosts Hercules needs to be a setuid root program to allow it to reset its dispatching priority to a high (negative) value (i.e. "chown root.root hercules; chmod +s hercules").

For Windows the following conversions are used for translating Linux/Unix thread priorities to Windows thread priorities:

Unix Thread Priority	Windows Thread Priority	Meaning
-20 to -16	Time Critical	Base priority of 15 for Idle, Below Normal, Normal, Above Normal, or High class processes, and a base priority of 31 for Realtime class processes.
-15 to -9	Highest	Priority 2 points above the priority class.
-8 to -1	Above Normal	Priority 1 point above the priority class.
0 to 7	Normal	Normal priority for the priority class.
8 to 15	Below Normal	Priority 1 point below the priority class.
16 to 19	Lowest	Priority 2 points below the priority class.
20	Idle	Base priority of 1 for Idle, Below Normal, Normal, Above Normal, or High class processes, and a base priority of 16 for Realtime class processes.

Table 5: Thread Priority Conversions

Caution: On Windows, your thread priority is interpreted differently based on your chosen process priority setting! You should never modify your thread priority settings without first reviewing your chosen process priority setting!

5. Device Definition Descriptions

5.1 Local non-SNA 3270 Devices

5.1.1 Function

The local non-SNA 3270 device statements are used to define terminals to the Hercules configuration. There are no required arguments for this particular device type but there are several optional arguments that may be specified.

To use this device a tn3270 client must connect to the host machine via the port number specified on the CNSLPORT statement. A valid tn3270 device type such as IBM-3278 must be used.

If the tn3270 client software allows it to specify a device type suffix (e.g. *IBM-3278@GROUPNAME*) then the suffix can be used to connect to that specific device number, if defined. If no suffix is used then the tn3270 client will be connected to the first available and defined 3270 device.

If a specific terminal device address is specified via the device type suffix of the tn3270 client software then it must be eligible to connect at that device address or the connection is immediately rejected. An alternative terminal device for which the tn3270 client might be eligible will not be automatically selected.

5.1.2 Syntax

Descriptive

```
devaddr devtype [{groupname | *} [ipaddr [mask]]]
```

Diagram

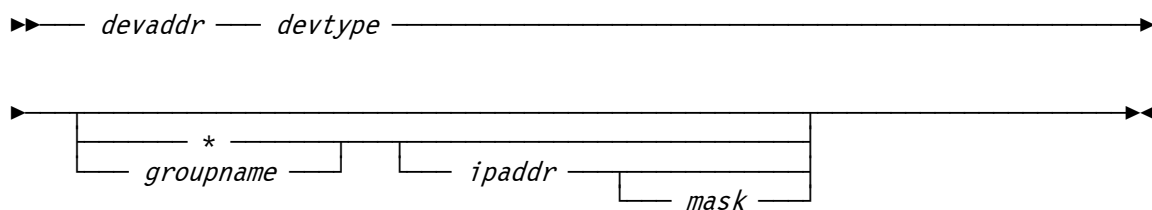

5.1.3 Parameter

devaddr This is the device address.

devtype This is the device type. Valid terminal device types are 3270 and 3278.

groupname If a terminal group name is given on the device statement then a device type suffix with this group name can be used to indicate that a device in this group is to be used. If a group name is specified as a terminal type suffix (e.g. *IBM-3278@GROUPNAME*) and there are no devices defined with that group name or no available devices remaining in

that group then the connection is rejected. If no group name is specified as a terminal type suffix then the connection will only be eligible to terminal devices which also have no group name specified.

The terminal group name should be 1-8 alphanumeric characters in length, the first character being alphabetic and it should not be a hexadecimal number. Upper and lower case letters in the group name are considered to be equivalent.

* The asterisk is used to indicate any terminal group name. It may be omitted if there are no additional arguments following the group name. If an IP address (and optionally mask) is specified and there is no specific group name desired then the asterisk must be coded to distinguish the terminal group name and the IP address arguments.

ipaddr [mask] The optional IP address and subnet masks specify the IP address(es) at which client(s) are allowed to connect via the device address identified by the device statement. This provides an additional means of specifying which device(s) a client tn3270 session may connect to.

If the IP address and mask (default 255.255.255.255 if not specified) of the tn3270 client attempting to connect match the IP address/mask entered on the device statement, then the client is eligible to connect at this device address. Otherwise the client is ineligible to connect at this device address and the next available device, if any, for which the client is eligible to connect, will be attempted.

If no permissible terminal devices remain (terminal devices for which the client is eligible to connect) or there are no more available terminal devices then the client connection is rejected.

The optional IP address and subnet mask may be specified in conjunction with the terminal group argument. In this case the terminal group argument must be specified ahead of the optional IP address and subnet mask arguments. To specify an IP address and a subnet mask without also specifying a terminal group use an asterisk (“*”) as the group name substitute or placeholder.

If an IP address / mask are not specified then any client tn3270 session is allowed to connect to the device (provided they are also a member of the specified terminal group, if any).

The terminal group name must match if specified, regardless of any optional IP address / mask. To summarize, the device number suffix always takes precedence over any group name and any group name always takes precedence over any IP address/mask value.

5.1.4 Examples

Example 1:

Define a 3270 device on device address 0200.

```
0200 3270
```

Example 2:

Define a 3270 device on device address 0200. Allow clients with any terminal group name but only from IP address 192.168.0.100 to connect.

```
0200 3270 * 192.168.0.100
```

Example 3:

Define a 3270 device on device address 0200. Allow clients with any terminal group name but only from IP address 192.168.0.100 with subnet mask 255.255.255.0 to connect.

```
0200 3270 * 192.168.0.100 255.255.255.0
```

Example 4:

Define a 3270 device on device address 0200. Allow only clients with terminal group name CONSOLE and from IP address 192.168.0.100 with subnet mask 255.255.255.0 to connect.

```
0200 3270 CONSOLE 192.168.0.100 255.255.255.0
```

Example 5:

Define a 3270 device on device address 0200. Allow only clients with terminal group name TSOTERM to connect.

```
0200 3270 TSOTERM
```

5.2 Integrated 3270 (SYSG) Console

5.2.1 Function

The integrated 3270 (SYSG) console is similar to a local non-SNA 3270 device, except that it is not addressed by a subchannel number and it is supported only by certain system control programs. The SYSG console is defined like a 3270 device except that the device type is SYSG and the device address is ignored. Only one SYSG console can be defined in a configuration.

Use tn3270 client software to connect to the SYSG console device via the port number specified on the CNSLPORT statement, just as you would connect to a regular local non-SNA 3270 device.

The SYSG console configuration statement recognizes optional arguments which specify group name and IP address in the same way as previously described for a local non-SNA 3270 device. These optional arguments provide a means to ensure that a given tn3270 client can connect directly to the SYSG console.

If the group name and IP address arguments are not specified, then the SYSG console is considered to be a member of the general pool of devices eligible for connection to any incoming tn3270 client.

5.2.2 Syntax

Descriptive

```
devaddr SYSG [{groupname | *} [ipaddr [mask]]]
```

Diagram

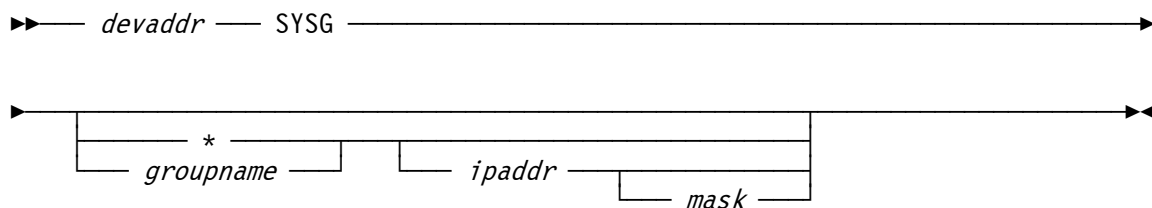

5.2.3 Parameter

devaddr This is the device address. In the case of the integrated 3270 (SYSG) console this address is ignored.

SYSG This is the device type. The only valid device type is SYSG.

groupname If a terminal group name is given on the device statement then a device type suffix with this group name can be used to indicate that a device in this group is to be used. If a group name is specified as a terminal type suffix (e.g. IBM-3278@GROUPNAME) and there are no devices defined with that group name or no available devices remaining in that group then the connection is rejected. If no group name is specified as a terminal type suffix then the connection will only be eligible to terminal devices which also have no group name specified.

The terminal group name should be 1-8 alphanumeric characters in length, the first character being alphabetic and it should not be a hexadecimal number. Upper and lower case letters in the group name are considered to be equivalent.

- * The asterisk is used to indicate any terminal group name. It may be omitted if there are no additional arguments following the group name. If an IP address (and optionally mask) is specified and there is no specific group name desired then the asterisk must be coded to distinguish the terminal group name and the IP address arguments.

ipaddr [mask] The optional IP address and subnet masks specify the IP address(es) at which client(s) are allowed to connect via the device address identified by the device statement. This provides an additional means of specifying which device(s) a client tn3270 session may connect to.

If the IP address and mask (default 255.255.255.255 if not specified) of the tn3270 client attempting to connect match the IP address/mask entered on the device statement, then the client is eligible to connect at this device address. Otherwise the client is ineligible to connect at this device address and the next available device, if any, for which the client is eligible to connect, will be attempted.

If no permissible terminal devices remain (terminal devices for which the client is eligible to connect) or there are no more available terminal devices then the client connection is rejected.

The optional IP address and subnet mask may be specified in conjunction with the terminal group argument. In this case the terminal group argument must be specified ahead of the optional IP address and subnet mask arguments. To specify an IP address and a subnet mask without also specifying a terminal group use an asterisk (“*”) as the group name substitute or placeholder.

If an IP address / mask are not specified then any client tn3270 session is allowed to connect to the device (provided they are also a member of the specified terminal group, if any).

The terminal group name must match if specified, regardless of any optional IP address / mask. To summarize, the device number suffix always takes precedence over any group name and any group name always takes precedence over any IP address/mask value.

5.2.4 Examples

Example 1:

Define an integrated 3270 (SYSG) console on device address 0000 (the device address is ignored for SYSG consoles).

```
0000 SYSG
```

Example 2:

Define an integrated 3270 (SYSG) console on device address 0000. Allow only clients with terminal group name SYSGCONS and from IP address 192.168.0.100 with subnet mask 255.255.255.0 to connect.

```
0000 SYSG SYSGCONS 192.168.0.100 255.255.255.0
```

Example 3:

Define an integrated 3270 (SYSG) console on device address 0000. Allow clients with any terminal group name but only from IP address 192.168.0.100 to connect.

```
0000 SYSG * 192.168.0.100
```

Example 4:

Define an integrated 3270 (SYSG) console on device address 0000. Allow only clients with terminal group name SYSGCONS and from IP address 192.168.0.100 to connect.

```
0000 SYSG SYSGCONS 192.168.0.100
```

Example 5:

Define an integrated 3270 (SYSG) console on device address 0000. Allow only clients with terminal group name SYSGCONS to connect.

```
0000 SYSG SYSGCONS
```

5.3 Console Printer-Keyboard Devices

5.3.1 Function

These device statements are used to define “Console Printer-Keyboard” devices to Hercules. To use the Console Printer-Keyboard device a telnet client must connect to the host machine via the port number specified on the CNSLPORT statement in that configuration file.

If the telnet client software allows it to specify a device type suffix (e.g. ansi@0009) then the suffix can be used to specify the specific 1052 or 3215 device to which the client should connect. If no suffix is used in the telnet client software (or the software does not allow it), then the client will be connected to the first available 1052 or 3215 device for which it is eligible.

5.3.2 Syntax

Descriptive

```
devaddr devtype [NOPROMPT] [{groupname | *} [ipaddr [mask]]]
```

Diagram

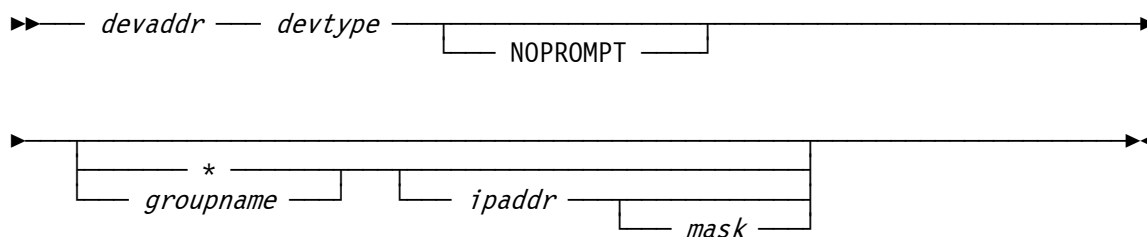

5.3.3 Parameter

devaddr This is the device address.

devtype This is the device type. Valid terminal device types are 1052 and 3215.

NOPROMPT The NOPROMPT argument may be specified to cause suppression of the “ENTER INPUT FOR CONSOLE DEVICE nnnn” prompt message which is otherwise normally issued to the device whenever the system is awaiting input from the device.

The NOPROMPT argument, if specified, must precede the optional group name and any ipaddr mask arguments.

groupname If a terminal group name is given on the device statement then a device type suffix with this group name can be used to indicate that a device in this group is to be used. If a group name is specified as a terminal type suffix (e.g. IBM-3278@GROUPNAME) and there are no devices defined with that group name or no available devices remaining in that group then the connection is rejected. If no group name is specified as a terminal type suffix then the connection will only be eligible to terminal devices which also have no group name specified.

The terminal group name should be 1-8 alphanumeric characters in length, the first character being alphabetic and it should not be a hexadecimal number. Upper and lower case letters in the group name are considered to be equivalent.

- * The asterisk is used to indicate any terminal group name. It may be omitted if there are no additional arguments following the group name. If an IP address (and optionally mask) is specified and there is no specific group name desired then the asterisk must be coded to distinguish the terminal group name and the IP address arguments.

ipaddr [mask] The optional IP address and subnet masks specify the IP address(es) at which client(s) are allowed to connect via the device address identified by the device statement. This provides an additional means of specifying which device(s) a client tn3270 session may connect to.

If the IP address and mask (default 255.255.255.255 if not specified) of the tn3270 client attempting to connect match the IP address/mask entered on the device statement, then the client is eligible to connect at this device address. Otherwise the client is ineligible to connect at this device address and the next available device, if any, for which the client is eligible to connect, will be attempted.

If no permissible terminal devices remain (terminal devices for which the client is eligible to connect) or there are no more available terminal devices then the client connection is rejected.

The optional IP address and subnet mask may be specified in conjunction with the terminal group argument. In this case the terminal group argument must be specified ahead of the optional IP address and subnet mask arguments. To specify an IP address and a subnet mask without also specifying a terminal group use an asterisk (“*”) as the group name substitute or placeholder.

If an IP address / mask are not specified then any client tn3270 session is allowed to connect to the device (provided they are also a member of the specified terminal group, if any).

The terminal group name must match if specified, regardless of any optional IP address / mask. To summarize, the device number suffix always takes precedence over any group name and any group name always takes precedence over any IP address/mask value.

5.3.4 Examples

Example 1:

Define a 1052 console printer-keyboard device on device address 0009.

```
0009 1052
```

Example 2:

Define a 1052 console printer-keyboard device on device address 0009 and suppress the “ENTER INPUT FOR CONSOLE DEVICE nnnn” prompt messages.

```
0009 1052 NOPROMPT
```

Example 3:

Define a 3215 console printer-keyboard device on device address 0009. Allow only clients with terminal group name CONSOLES and from IP address 192.168.0.100 to connect.

```
0009 3215 CONSOLES 192.168.0.100 255.255.255.0
```

Example 4:

Define a 3215 console printer-keyboard device on device address 0009. Allow only clients with terminal group name CONSOLES and from IP address 192.168.0.100 with subnet mask 255.255.255.0 to connect. Additionally suppress the “ENTER INPUT FOR CONSOLE DEVICE nnnn” prompt messages.

```
0009 3215 NOPROMPT CONSOLES 192.168.0.100 255.255.255.0
```

Example 5:

Define a 3215 console printer-keyboard device on device address 0009. Allow clients with any terminal group name but only from IP address 192.168.0.100 with subnet mask 255.255.255.0 to connect. Additionally suppress the “ENTER INPUT FOR CONSOLE DEVICE nnnn” prompt messages.

```
0009 3215 NOPROMPT * 192.168.0.100 255.255.255.0
```

5.4 Integrated Console Printer-Keyboard Devices

5.4.1 Function

These device statements are used to define “Integrated Console Printer-Keyboard” devices to the Hercules configuration. The statements have one optional argument, the default command prefix for sending input to the device. The default command prefix is “/”. All integrated devices must use a different command prefix.

To send a logon command to a 1052-C or 3215-C enter “/logon” on the Hercules console.

5.4.2 Syntax

Descriptive

```
devaddr devtype [{prefix | /}]
```

Diagram

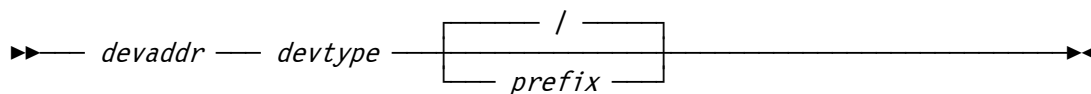

5.4.3 Parameter

devaddr This is the device address.

devtype This is the device type. Valid terminal device types are 1052-C and 3215-C.

prefix This is the command prefix for the device. The default command prefix is “/”. All devices must use a different command prefix.

5.4.4 Examples

Example 1:

Define a 3215-C integrated console printer-keyboard device on device address 0009. Specify “/” as command prefix.

```
0009 3215-C /
```

5.5 Card Reader Devices

5.5.1 Function

The card reader device statements are used to define card readers to the Hercules configuration. The argument specifies a list of file names containing card images. Additional arguments can be defined after the file names.

5.5.2 Syntax

Descriptive

```
devaddr devtype filename [ filename ... ] [SOCKDEV] [EOF] [INTRQ]
[MULTIFILE] [EBCDIC [AUTOPAD]] [ASCII [TRUNC]]
```

Diagram

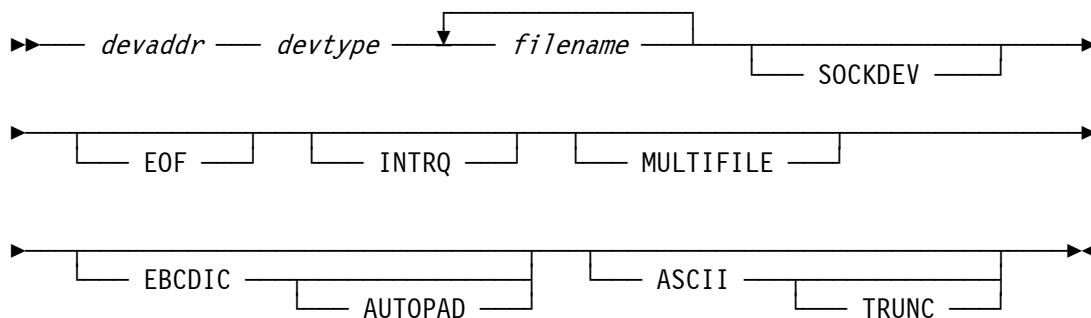

5.5.3 Parameter

- devaddr** This is the device address.
- devtype** This is the device type. Valid card reader types are 1442, 2501, 3505.
- filename** The name (and optionally the path) of the card reader file.
- SOCKDEV** Indicates that the card reader is a socket device, wherein the filename is actually a socket specification instead of a device filename. When used, there must be only one filename specified in the form "*port*", "*host:port*" or "*sockpath/sockname*". The device then accepts remote connections on the given TCP/IP port or Unix domain socket and reads data from the socket instead from a device file. This allows automatic remote submission of card reader data. See chapter "Submitting Jobs via the Socket Reader" for more details.
- EOF** EOF specifies that unit exception status is presented after reading the last card in the file. This option is persistent and will remain in effect until the reader is reinitialized with the INTRQ option.

INTRQ	INTRQ specifies that unit check status with intervention required sense bytes is presented after reading the last card in the file. This option is persistent and will remain in effect until the reader is reinitialized with the EOF option.
MULTIFILE	Specifies, when multiple files are entered, to automatically open the next input file and continue reading whenever EOF is encountered on a given file. If not specified reading stops once EOF is reached on a given file and an attention interrupt is required to open and begin reading the next file.
EBCDIC	Specifies that the file contains fixed length 80-byte EBCDIC records with no line-end delimiters.
ASCII	Specifies that the file contains variable length lines of ASCII characters delimited by LF (line feed) or CRLF (carriage return line feed) sequences at the end of each line. If neither EBCDIC or ASCII is coded then the device handler attempts to detect the format of the card image file when the device is first accessed. Auto-detection is not supported for socket devices and the default is ASCII if SOCKDEV is specified.
TRUNC	With ASCII files, TRUNC defines, that lines longer than 80 characters are truncated instead of producing a unit check error.
AUTOPAD	With EBCDIC files, AUTOPAD defines, that the file is automatically padded to a multiple of 80 bytes if necessary.

5.5.4 Examples

Example 1:

Define a 3505 card reader device on device address 000C. The name and path of the card reader file is "D:/JCL/DUMMY.JCL". A unit exception status has to be presented after reading the last card in the file.

```
000C 3505 D:/JCL/DUMMY.JCL EOF
```

Example 2:

Define a 1442 card reader device on device address 000C. The name and path of the card reader file is "D:/JCL/JCL.TXT". The file contains fixed length 80-byte EBCDIC records, automatically padded to a multiple of 80 bytes if necessary. A unit check status with intervention required sense bytes has to be presented after reading the last card in the file.

```
000C 1442 D:/JCL/JCL.TXT EBCDIC AUTOPAD INTRQ
```

Example 3:

Define a 2501 card reader device on device address 000C. The card reader is a socket device accepting remote connections from address 127.0.0.1 port 2501. The file contains variable length lines of ASCII characters delimited by line feed or carriage return line feed sequences at the end of each line. Lines longer than 80 bytes have to be truncated and a unit exception status has to be presented after reading the last card in the file.

```
000C 2501 127.0.0.1:2501 SOCKDEV ASCII TRUNC EOF
```

5.6 Card Punch Devices

5.6.1 Function

The card punch statement defines a card punch device to the Hercules configuration. The argument specifies the name of the file to which the punched output will be written. Additional arguments may be specified after the filename.

5.6.2 Syntax

Descriptive

```
devaddr devtype filename [ASCII] [CRLF] [NOCLEAR]
```

Diagram

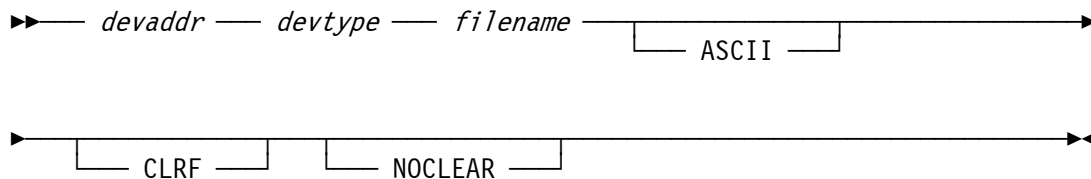

5.6.3 Parameter

- devaddr** This is the device address.
- devtype** This is the device type. A valid card punch type is 3525.
- filename** The name (and optionally the path) of the card punch file.
- ASCII** ASCII specifies that the file will be written as variable length lines of ASCII characters, delimited by line feeds or carriage return line feed sequences. Trailing blanks are removed from each line. If the ASCII argument is not specified, the file is written as fixed length 80-byte EBCDIC records with no line-end delimiters.
- CRLF** This optional parameter specifies that carriage return line feed sequences are written at the end of each line. If the CRLF argument is not specified, line feeds are only written at the end of each line.
- NOCLEAR** This argument specifies that the output file will not be cleared to zero bytes when it is opened. If NOCLEAR is not specified, then any previous content of the file is destroyed when the file is opened for output.

5.6.4 Examples

Example 1:

Define a 3525 card punch device on device address 000D. The punched output has to be written to the file "D/PCH/PCH1.TXT" as variable length lines of ASCII records delimited by carriage return line feed sequences. Any existing output in the file has to be kept when the file is opened for output.

```
000D 3525 D:/PCH/PCH1.TXT ASCII CRLF NOCLEAR
```

Example 2:

Define a 3525 card punch device on device address 000D. The punched output has to be written to the file "D/PCH/PCH2.TXT" as fixed length 80-byte EBCDIC records with no line-end delimiters. Any existing output in the file will be destroyed when the file is opened for output.

```
000D 3525 D:/PCH/PCH2.TXT
```

5.7 Line Printer Devices

5.7.1 Function

The line printer device statement defines a printer to the Hercules configuration. The argument specifies the name of a file to which the printer output will be written. The output is written in the form of variable length lines of ASCII characters, delimited by line feeds or carriage return line feed sequences. Trailing blanks are removed from each line. Carriage control characters are translated to blank lines or ASCII form feed characters. If the file exists it will be overwritten.

If the filename begins with the vertical bar '|' pipe character, then it is removed and the remainder of the filename is interpreted as a command line (the name of a program or batch file followed by any necessary arguments) to which to "pipe" the printer output to. This is known as the "print-to-pipe" feature. All printer output is then sent to the piped program's stdin input, and all of the piped program's stdout and stderr output is piped back to Hercules for displaying on the hardware console.

SOCKDEV indicates that the line printer is a socket device wherein the filename is actually a socket specification in the form *host:port* instead of a device filename. The device then accepts remote connections on the given TCP/IP port and writes data to the socket instead to a device file. A Windows software that supports a socket printer is Fish's "HercPrt" (Hercules Remote Printer Spooler). It spools the print output from a Hercules socket printer and creates either PDF, RTF or just plain text files. A control file enables HercPrt to split the printouts on job separator page boundaries and name the file according to the actual job accounting field values.

5.7.2 Syntax

Descriptive

```
devaddr devtype filename [CRLF] [NOCLEAR]
```

or

```
devaddr devtype [host:]port SOCKDEV
```

Diagram

```
▶▶— devaddr — devtype — filename —————▶  
                                          └── CLRF ─┘
```

```
▶└───┬───┬───┬───┬───┬───┬───┬───┬───┬───▶  
     └── NOCLEAR ─┘
```

or

```
▶▶— devaddr — devtype —————▶  
                                  └── host: ─┘ port — SOCKDEV —▶▶
```

5.7.3 Parameter

devaddr	This is the device address.
devtype	This is the device type. Valid printer types are 1403 and 3211.
filename	<p>The name (and optionally the path) of the printer file or the "print-to-pipe" command line. If the filename begins with the vertical bar ' ' pipe character, then it is removed and the remainder of the filename is interpreted as a command line (the name of a program or batch file followed by any necessary arguments) to which to "pipe" the printer output to. This is known as the "print-to-pipe" feature. All printer output is then sent to the piped program's stdin input, and all of the piped program's stdout and stderr output is piped back to Hercules for displaying on the hardware console.</p> <p>If the "print-to-pipe" command line contains arguments, then quotes must be placed around the entire filename string including the vertical bar. If the "print-to-pipe" command line itself contains quotes, then the command line must be enclosed in apostrophes instead of quotes.</p>
CRLF	This optional parameter specifies that carriage return line feed sequences are written at the end of each line. If the CRLF argument is not specified then line feeds only are written at the end of each line.
NOCLEAR	This argument specifies that the output file will not be cleared to zero bytes when it is opened. If NOCLEAR is not specified, then any previous content of the file is destroyed when the file is opened for output.
SOCKDEV	SOCKDEV indicates that the line printer is a socket device wherein the filename is actually a socket specification instead of a device filename. When used, there must only be one filename specified in the form <i>port</i> or <i>host:port</i> . The device then accepts remote connections on the given TCP/IP port and writes data to the socket instead to a device file. This allows automatic remote spooling of line printer data. The sockdev option is mutually exclusive with all other printer options (like CRLF etc.) and must be specified alone.

5.7.4 Examples

Example 1:

Define a 1403 line printer device on device address 000E. The printed output has to be written to the file "D:\PRT\PRT1.TXT" with carriage return line feed sequences at the end of each line. Any existing output in the file has to be kept when the file is opened for output.

```
000E 1403 D:/PRT/PRT1.TXT CRLF NOCLEAR
```

Example 2:

Define a 3211 line printer device on device address 000F. The printed output has to be written to the file "D:\PRT\PRT2.TXT" with line feeds only at the end of each line. Any existing output in the file will be overwritten when the file is opened for output.

```
000F 3211 D:/PRT/PRT2.TXT
```

Example 3:

Define a 1403 line printer device on device address 000E. The line printer is a socket device with the IP address 192.168.0.199 and port 1403. Output is written to the socket instead to a device file.

```
000E 1403 192.168.0.199:1403 SOCKDEV
```

Example 4:

Define a 1403 line printer device on device address 000E. The command line for the print-to-pipe feature is "/usr/bin/lpr", the argument for the 'lpr' program is "-Phplj" (Unix example). In the case of the Windows example the command line for the print-to-pipe feature is "C:\utils\pr", the argument for the 'pr' program is "-PLPT1:". Each printed line will have a carriage return line feed sequence at the end.

```
000E 1403 "|/usr/bin/lpr -Phplj" crlf      (for Unix)
```

```
000E 1403 "|c:\utils\pr -s -PLPT1:" crlf  (for Windows)
```

5.8 Emulated Tape Devices

Tape device statements are used to define tape devices to the Hercules configuration. Five types of emulation are supported:

- SCSI tapes
- Optical Media Attach (OMA) virtual files
- AWSTAPE virtual files
- HET virtual files
- Fake Tape virtual files

5.8.1 SCSI Tapes

5.8.1.1 Function

When defining SCSI tapes the argument specifies the tape device name (usually **/dev/nst0**). SCSI tapes are read and written using variable length EBCDIC blocks and filemarks exactly like a mainframe tape volume (see also the `AUTO_SCSE_MOUNT` system parameter).

5.8.1.2 Syntax

Descriptive

```
devaddr devtype devname [--no-erg] [--blkid-32 | --blkid-22]
```

Diagram

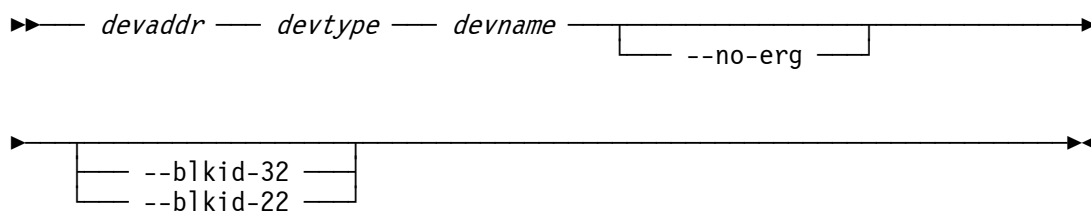

5.8.1.3 Parameter

- devaddr** This is the device address.
- devtype** This is the device type. Valid device types are 3410, 3420, 3422, 3430, 3480, 3490, 8809 and 9347.
- devname** The tape device name (usually **/dev/nst0** on Linux or **\\.\Tape0** on Windows).
- no-erg** This option is intended to prevent issuance of the Erase Gap command to those SCSI tape drives that do not support it (e.g. Quantum DLT series). It causes Hercules's device emulation logic to ignore any Erase Gap commands issued to the drive and to return immediate 'success' instead.

This option should only be used (specified) for drives such as the Quantum which support switching from read mode to write mode in the middle of a data stream without the need of an intervening Erase Gap command. Specifying it for any other model SCSI drive may cause incorrect functioning as a result of the Erase Gap command not being issued to the actual SCSI hardware.

Check the manufacturer information for your particular model of SCSI-attached tape drive (and/or use Fish's "ftape" Windows utility) to determine whether or not this option is needed for your particular drive.

--blkid-32 This option indicates that your SCSI-attached tape drive only supports 32-bit block-ids (as used by 3590 drives) and not the 22-bit format used by 3480/3490 drives. You should only specify this option if you intend to define the drive as a model 3480 or 3490 device and then only if your actual SCSI drive uses 32-bit block-ids. If you define your Hercules tape drive as a model 3590 device however this option is not required as 3590 drives are already presumed to use 32-bit block-ids.

Specifying this option on a 3480/3490 device statement will cause Hercules device emulation logic to automatically translate the actual SCSI tape drive's 32-bit block-id into 22-bit format before returning it back to the guest operating system (since that is the format it expects it to be in for a model 3480/3490 drive), and to translate the guest's 22-bit format block-id into 32-bit format before sending it to the actual SCSI hardware (since that is the format that the actual hardware requires it to be in).

--blkid-22 The opposite of the above --blkid-32 option.

5.8.1.4 Examples

Example 1:

Define a 3420 tape device on device address 0580. The tape device is a SCSI-attached tape drive which only supports 32-bit block-ids.

```
0580 3420 /dev/nst0 --blkid-32
```

5.8.2 Optical Media Attach (OMA) virtual files

5.8.2.1 Function

OMA device statements are used to define Optical Media Attach (OMA) virtual files to the Hercules configuration. OMA virtual files are read-only files which normally reside on CDROM. OMA virtual tapes consist of one CDROM file corresponding to each physical file of the emulated tape. An ASCII text file called the "Tape Descriptor File" (TDF) specifies the names of the files which make up the virtual tape. The argument specifies the name of the tape descriptor file.

Each file on the virtual tape can be in one of the following three formats:

TEXT TEXT files consist of variable length ASCII records delimited by carriage return line feed (CRLF) sequences at the end of each record. Each record is translated to EBCDIC and presented to the program as one physical tape block.

FIXED nnnnn FIXED files consist of fixed length EBCDIC blocks of the specified length (nnnnn).

HEADERS HEADERS files consist of variable length EBCDIC blocks. Each block is preceded by a 12-byte header.

If you have any IBM manuals in BookManager format on CDROM, you can see some examples of TDF files in the "\TAPES" directory on the CDROM.

5.8.2.2 Syntax

Descriptive

devaddr devtype tdf

Diagram

▶— *devaddr* — *devtype* — *tdf* —▶

5.8.2.3 Parameter

devaddr This is the device address

devtype This is the device type Valid device types are 3410, 3420, 3422, 3430, 3480, 3490, 8809 and 9347.

tdf The filename (and path) of the tape descriptor file.

5.8.2.4 Examples

Example 1:

Define a 3480 tape device on device address 0582. The tape device is an Optical Media Attach (OMA) virtual file (CD-ROM). The filename of the Tape Descriptor File (TDF) is "UAA186.TDF" located in path "/CDROM/TAPES/".

```
0582 3480 /CDROM/TAPES/UAA186.TDF
```

5.8.3 AWSTAPE virtual files

5.8.3.1 Function

AWSTAPE device statements are used to define AWSTAPE virtual files to the Hercules configuration. AWSTAPES contain a complete tape in one file. AWSTAPE files consist of variable length EBCDIC blocks. Each block is preceded by a 6-byte header. Filemarks are represented by a 6-byte header with no data. This is the same format as is used by the IBM P/390 systems. The argument specifies the location of the AWSTAPE file.

5.8.3.2 Syntax

Descriptive

*devaddr devtype {awsfile | *} [arguments]*

where arguments are:

[MAXSIZE={*n* | 0} | MAXSIZEK={*n* | 0} | MAXSIZEM={*n* | 0}]

[EOTMARGIN=*n*]

[READONLY={0 | 1}]

[RO | NORING | RW | RING]

[DEONIRQ={0 | 1}]

[NOAUTOMOUNT]

Diagram

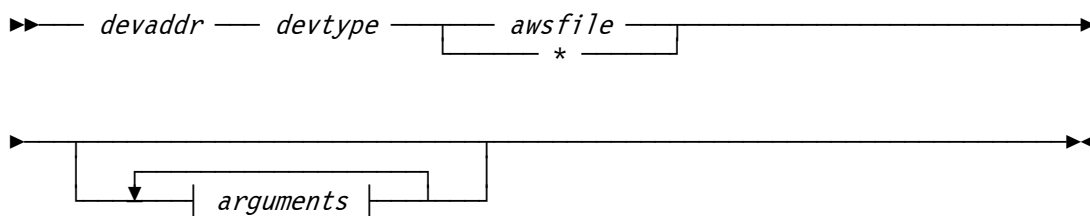

where arguments are:

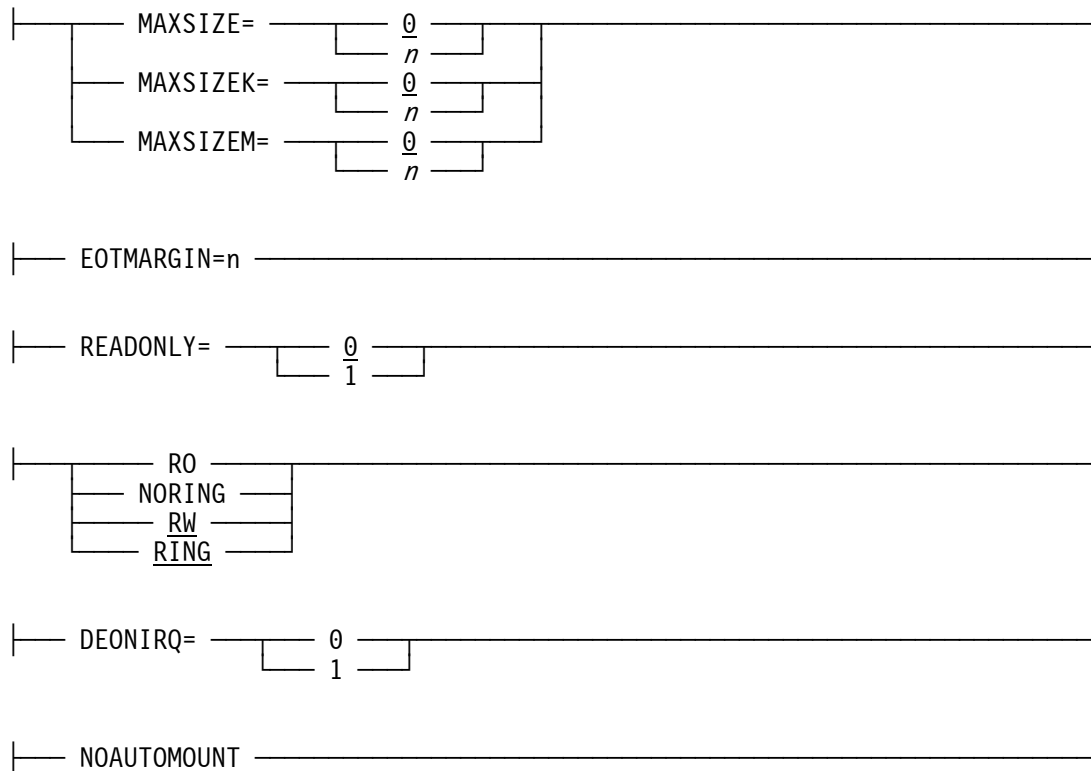

5.8.3.3 Parameter

devaddr	This is the device address.
devtype	This is the device type. Valid device types are 3410, 3420, 3422, 3430, 3480, 3490, 8809 and 9347.
awsfile	The filename (and path) of the AWSTAPE file or “*”. An asterisk defines an empty tape station. The tape must be manually be loaded on request.

If the filename starts with the “@” character (at sign), the file then describes a list of tape emulation files to be loaded in succession. The syntax of each line in this file is identical to the information that can be coded directly after the device type in the overall configuration file. Any emulation file name parameter specified in this file may be substituted by the character “*”, in which case it specifies a set of options to be applied to all additional emulation files specified in the list.

This function emulates an Automatic Cartridge Feeder (ACF. The ACF is a feature on cartridge type tape drives (3480, 3490, etc..) that automatically loads a new tape when a tape is removed from the drive. There is no real control over this device by the host as it just keeps on feeding tapes one after the other. Although the ACF feature is unique to cartridge type systems, the emulation accepts the use of the same technique for emulated 1/2 inch tapes reel drives as well.

Parameters are appended in succession. In all cases, if the same parameter is coded more than once, the last instance takes precedence. Therefore it is possible to specify a set of parameters in the base configuration file, another on an “*” line and another for each individual line in the list of files. Parameters are then appended in that order. A SCSI tape device should not be given in a file list.

The remaining parameters are described in section 5.8.6 (“Common parameters for AWS, HET and FakeTape virtual files”).

5.8.3.4 Examples

Example 1:

Define a 3490 tape device on device address 0580. The tape device is an AWSFILE virtual file named "R0673A.AWS" located in path "/S390/TAPES/".

```
0580 3490 /S390/TAPES/R0673A.AWS
```

5.8.4 HET virtual files

5.8.4.1 HET virtual files

HET device statements are used to define HET virtual files to the Hercules configuration. These contain a complete tape in one file and have the same structure as the AWSTAPE format with the added ability to have compressed data.

The first argument specifies the location of the HET file. The filename must end with “.HET” to be recognized by Hercules as a HET file (e.g. “023178.HET”). There are several additional arguments that control various HET settings.

5.8.4.2 Syntax

Descriptive

*devaddr devtype {hetfile | *} [arguments]*

where arguments are:

[AWSTAPE]

[COMPRESS={0 | 1}]

[IDRC={0 | 1}]

[METHOD={1 | 2}]

[LEVEL={*n* | 4}]

[CHUNKSIZE={*nnnnn* | 65535}]

[MAXSIZE={*n* | 0} | MAXSIZEK={*n* | 0} | MAXSIZEM={*n* | 0}]

[EOTMARGIN=*n*]

[READONLY={0 | 1}]

[STRICTSIZE={0 | 1}]

[RO | NORING | RW | RING]

[DEONIRQ={0 | 1}]

[NOAUTOMOUNT]

Diagram

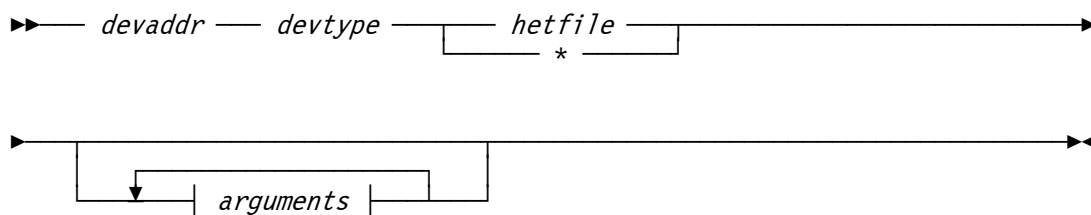

where arguments are:

|— AWSTAPE —————|

|— COMPRESS= ——— 0 ———|
 | |

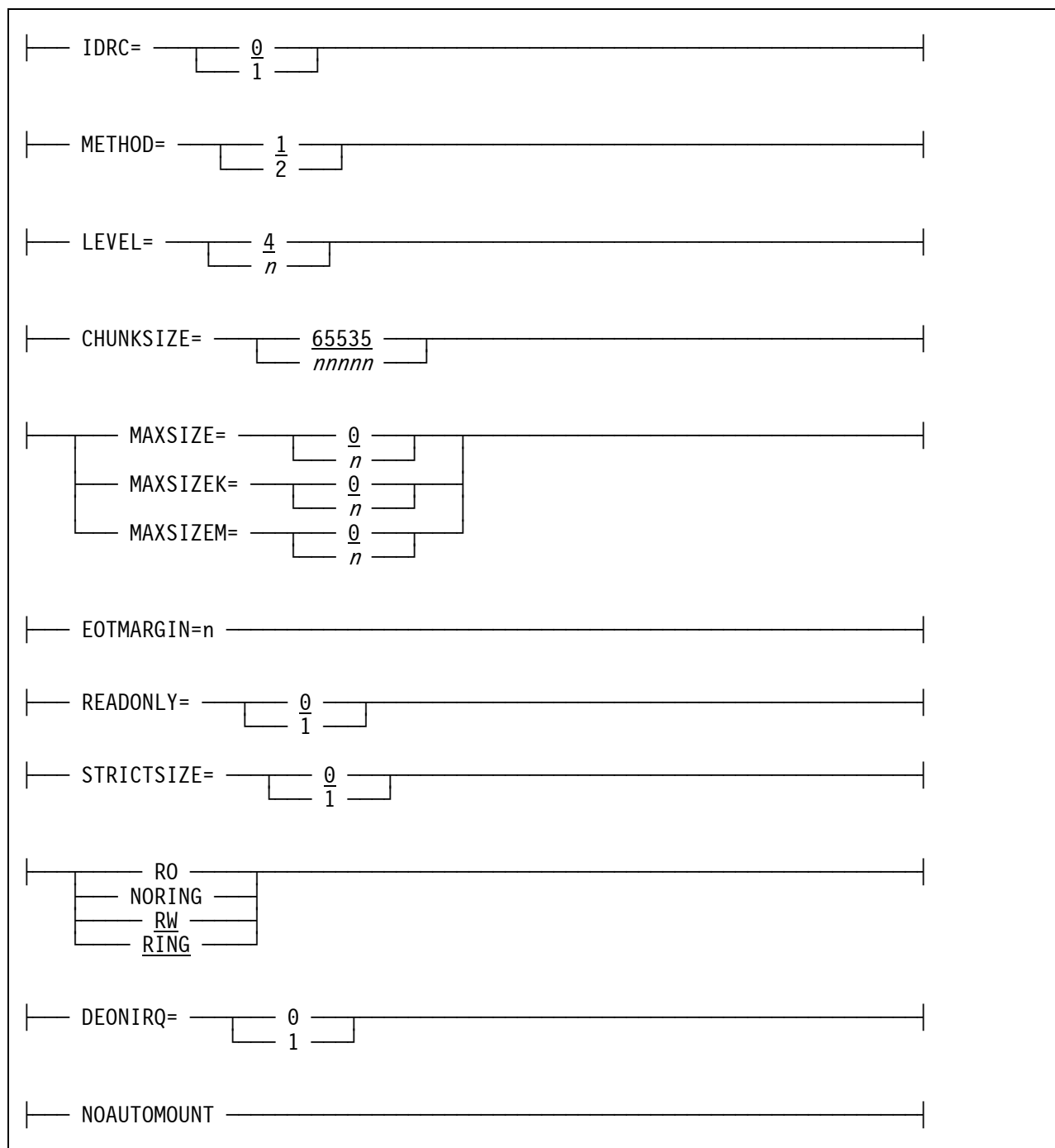

5.8.4.3 Parameter

- devaddr** This is the device address.
- devtype** This is the device type. Valid device types are 3410, 3420, 3422, 3430, 3480, 3490, 8809 and 9347.
- hetfile** The filename (and path) of the HET file or “*”. An asterisk defines an empty tape station. The tape must be manually loaded on request.
- If the filename starts with the “@” character (at sign), the file then describes a list of tape emulation files to be loaded in succession. The syntax of each line in this file is identical

to the information that can be coded directly after the device type in the overall configuration file. Any emulation file name parameter specified in this file may be substituted by the character "*", in which case it specifies a set of options to be applied to all additional emulation files specified in the list.

This function emulates an Automatic Cartridge Feeder (ACF). The ACF is a feature on cartridge type tape drives (3480, 3490, etc..) that automatically loads a new tape when a tape is removed from the drive. There is no real control over this device by the host as it just keeps on feeding tapes one after the other. Although the ACF feature is unique to cartridge type systems, the emulation accepts the use of the same technique for emulated 1/2 inch tapes reel drives as well.

Parameters are appended in succession. In all cases, if the same parameter is coded more than once, the last instance takes precedence. Therefore it is possible to specify a set of parameters in the base configuration file, another on an "*" line and another for each individual line in the list of files. Parameters are then appended in that order. A SCSI tape device should **not** be given in a file list!

- AWSTAPE** The AWSTAPE argument causes HET files to be written in AWSTAPE format. This disables the additional feature provided by the HET format.
- IDRC=n** COMPRESS and IDRC control whether compression should be used when writing to HET files. The value of *n* can be "1" to turn compression on (the default), or can be "0" to turn compression off. IDRC is currently a synonym for COMPRESS but may be used in the future to control another emulated tape drive feature. Therefore COMPRESS is the preferred method to turn compression on or off.
- COMPRESS=n** Same as above.
- METHOD=n** The METHOD argument allows you to specify which compression method to use. A value of "1" forces the use of ZLIB compression. A value of "2" forces the use of BZIP2 compression. The default is "1".
- LEVEL=n** The LEVEL option controls the level of compression. It ranges from "1" (for fastest compression) to "9" (for best compression). The default compression level is "4".
- CHUNKSIZE=nnnnn** The CHUNKSIZE option allows you to create HET files with different chunk sizes. The AWSTAPE (and therefore HET) formats allow each tape block to be logically broken up into smaller chunks. For instance, if the S/3x0 application creates tapes with a block size of 27998, those blocks would be broken down into *nnnnn* sized chunks. Although possible it is not recommended to change the chunk size, as decreasing this may reduce compression performance. The range of *nnnnn* is from 4096 to 65535. 65535 being the default.
- STRICTSIZE=n** Upon reaching the tape file size limit, depending on strictsize, the tape file will or will not be truncated to enforce the maxsize limit. The limit is only enforced during a write type operation. If the file already exists and the program only reads the file, then the file will not be truncated, regardless of the strictsize setting.

This affects any write that starts below the limit, but that would extend beyond the limit. The STRICTSIZE parameter only affects compressed HET files. On AWS tapes, the limit is always enforced, but the file is not truncated (the write does not occur, because first AWS tapes are never truncated and second the effects of the write are known in advance).

Regardless of strictsize, any write operation (Write, Write TM) will return a Unit Check with Equipment Check to the program if the file size exceeds the predefined limit. If STRICTSIZE is "0", the write will actually have been performed on the tape file. When STRICTSIZE is set to "1", the file will be truncated on the preceding tape block boundary.

Care must be taken that regardless of the STRICTSIZE setting, the tape may become unusable for the guest program should such an event occur (absence of a Tape Mark for example). This option has no effect if maxsize is 0. The default is "0" (do not truncate).

The remaining parameters are described in section 5.8.6 (“Common parameters for AWS, HET and FakeTape virtual files”).

5.8.4.4 Examples

Example 1:

Define a 3490 tape device on device address 0580. The tape device is a HET virtual file with name "R0674A.HET" located in path "/S390/TAPES/". BZIP2 compression has to be turned on at a level of 9 (best compression).

```
0580 3490 /S390/TAPES/R0674A.HET COMPRESS=1 METHOD=2 LEVEL=9
```

5.8.5 Fake Tape virtual files

5.8.5.1 Function

Fake Tape virtual files contain a complete tape in one file. FakeTape files consist of variable length EBCDIC blocks. Each block is preceded by a 12-byte ASCII-hex-character header. Filemarks are represented by a 12-byte character header with no data. The FakeTape format is used by the Flex-ES system from Fundamental Software Inc (FSI). The argument specifies the location of the FakeTape file (for example "ickdsf.fkt"). "FLEX-ES" and "FakeTape" are trademarks of Fundamental Software, Inc.

5.8.5.2 Syntax

Descriptive

```
devaddr devtype { fakefile | * } [arguments]
```

where arguments are:

```
[MAXSIZE={n | 0} | MAXSIZEK={n | 0} | MAXSIZEM={n | 0}]
```

```
[EOTMARGIN=n]
```

```
[READONLY={0 | 1}]
```

```
[RO | NORING | RW | RING]
```

```
[DEONIRQ={0 | 1}]
```

```
[NOAUTOMOUNT]
```

Diagram

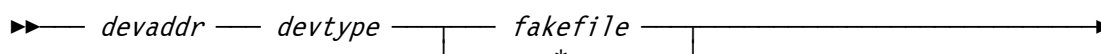

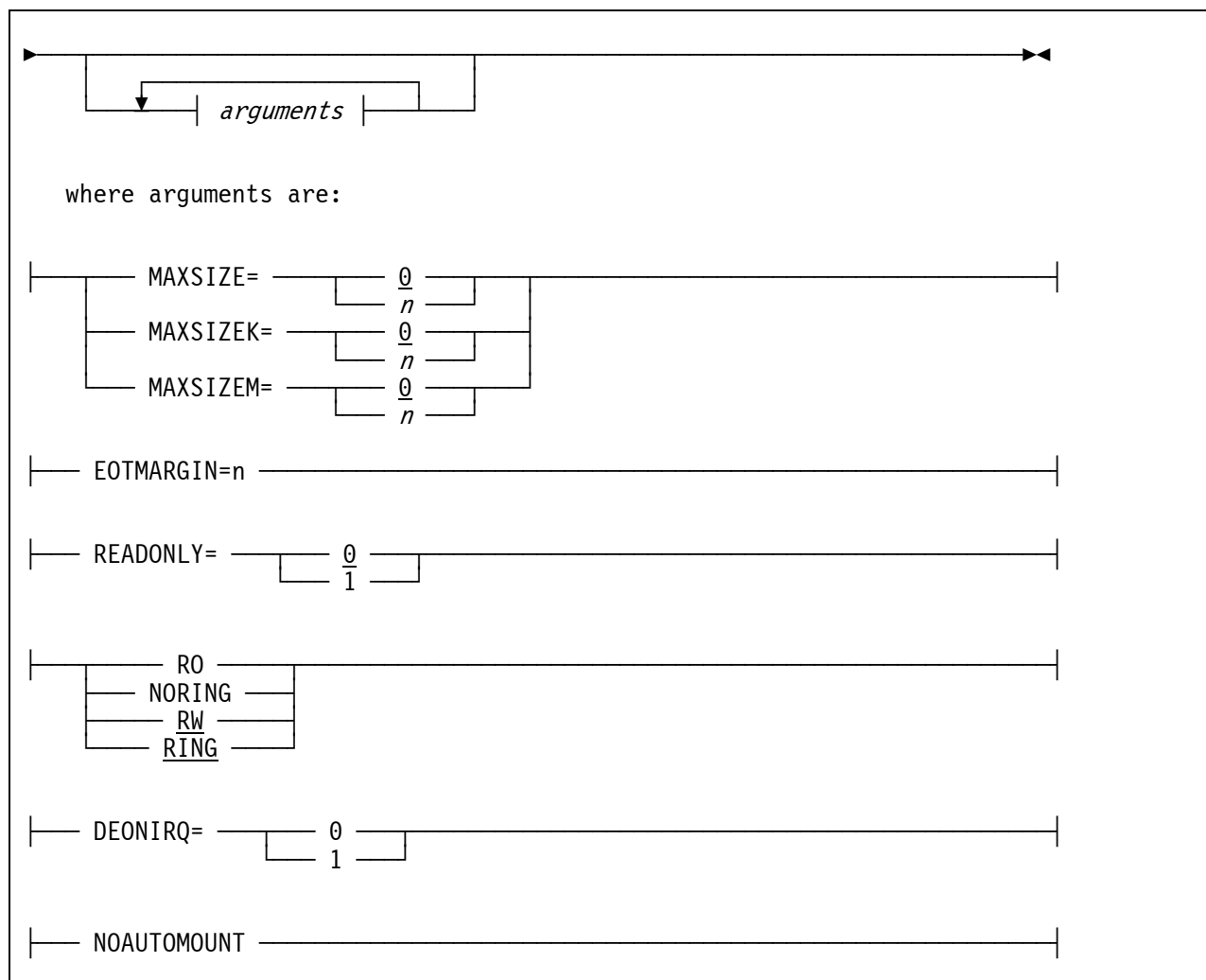

5.8.5.3 Parameter

- devaddr** This is the device address.
- devtype** This is the device type. Valid device types are 3410, 3420, 3422, 3430, 3480, 3490, 8809 and 9347.
- fakefile** The filename (and path) of the Fake Tape virtual file or "*". An asterisk defines an empty tape station. The tape must be manually be loaded on request.

If the filename starts with the "@" character (at sign), the file then describes a list of tape emulation files to be loaded in succession. The syntax of each line in this file is identical to the information that can be coded directly after the device type in the overall configuration file. Any emulation file name parameter specified in this file may be substituted by the character "*", in which case it specifies a set of options to be applied to all additional emulation files specified in the list.

This function emulates an Automatic Cartridge Feeder (ACF. The ACF is a feature on Cartridge type tape drives (3480, 3490, etc..) that automatically loads a new tape when a tape is removed from the drive. There is no real control over this device by the host as it just keeps on feeding tapes one after the other. Although the ACF feature is unique to cartridge type systems, the emulation accepts the use of the same technique for emulated 1/2 inch tapes reel drives as well.

Parameters are appended in succession. In all cases, if the same parameter is coded more than once, the last instance takes precedence. Therefore it is possible to specify a set of parameters in the base configuration file, another on an "*" line and another for each individual line in the list of files. Parameters are then appended in that order. A SCSI tape device should not be given in a file list.

The remaining parameters are described in section 5.8.6 ("Common parameters for AWS, HET and FakeTape virtual files").

5.8.5.4 Examples

Example 1:

Define a 3490 tape device on device address 0580. The tape device is an Fake Tape virtual file named "R0528A.FKT" located in path "/S390/TAPES/".

```
0580 3490 /S390/TAPES/R0528A.FKT
```

5.8.6 Common parameters for AWS, HET and Fake Tape virtual files

MAXSIZE=n This specifies the maximum number of bytes (specified in Bytes) for the emulated file. This parameter defaults to "0", meaning there is no limit on the file size.

MAXSIZEK=n This is the same as above but specified in Kilobytes.

MAXSIZEM=n This is the same as above but specified in Megabytes.

EOTMARGIN=n Specifies the number of bytes remaining (before reaching *MAXSIZE*) at which point the tape device will signal the presence of the "End-of-Tape" marker, thus allowing the program to switch to the next tape.

READONLY=n Specifies whether the tape is mounted read-only (without a write ring or with the cartridge protect switch set to "write protect"). A parameter of 1 means read-only; a parameter of 0 means read-write. If **READONLY=1**, **RO** or **NORING** is not specified; **READONLY=0** is the default. Note that **READONLY=0** does not override the host system file permission settings for the underlying AWS or HET file. If the AWS or HET file is marked read-only, the tape will be mounted read-only despite specification of **READONLY=0**.

RO / NORING Specifies that the tape is mounted read-only (without a write ring or with the cartridge protect switch set to "write protect"). **RO** and **NORING** are equivalent to **READONLY=1**.

RW / RING Specifies that the tape should be mounted read-write, if possible. **RW** and **RING** are equivalent to **READONLY=0**. This is the default if **RO**, **NORING** or **READONLY=1** is not specified. Note that **RW** and **RING** do not override the host system file permission settings for the underlying AWS or HET file. If the AWS or HET file is marked read-only, the tape will be mounted read-only despite specification of **RW** or **RING**.

DEONIRQ=n Specifies whether a device end is presented if intervention is required during tape motion. A parameter of 1 selects this option; a parameter of 0 turns it off.

NOAUTOMOUNT Indicates that support for guest-initiated automatic tape volume mounting is to always be disabled for this tape device. Automatic guest tape-mount support is automatically globally enabled for all virtual (non-SCSI) tape devices by default whenever an allowable automount directory is defined via the **AUTOMOUNT** configuration file statement or the automount console command. The **NOAUTOMOUNT** option allows you to specifically disable such support for a given device.

The automount feature enables software running in guest operating systems to automatically mount, unmount and/or query for themselves the host "virtual tape volume"

filename mounted on a tape drive, via the use of special CCW opcodes (0x4B Set Diagnose and 0xE4 Sense ID) without any intervention on the part of the Hercules operator. An example of such a program for DOS/VSE called TMOUNT is provided in the util subdirectory of the distributed source code.

This is a sticky option. When specified, automount support for the device remains disabled until the option is specifically removed via a devinit command without the option specified. This means if NOAUTOMOUNT is enabled for a device while global automount functionality is currently disabled (because no AUTOMOUNT statement was specified at Hercules startup), then automount functionality remains disabled for the device even should global automount functionality be later manually enabled via an automount console command.

When the 0x4B Set Diagnose CCW is used to auto-mount a virtual tape volume onto a given tape drive, an absolute (fully-qualified) pathname should normally always be specified, but need not be if a path relative to the currently defined "default allowable" automount directory is used instead.

The default allowable automount directory is always the first "allowable" directory that was defined, or else the current directory if no allowable directories were specifically defined. There is always a default allowable directory whenever any allowable or unallowable automount directories are defined.

Fully-resolved, absolute-full-path filenames are defined as being those which, for Windows, have a ':' (colon) in the second position or, for other host operating systems (e.g. Linux), have a '/' (slash) in the first position. Paths which start with a '.' (period) are considered relative paths and will always be appended to the currently defined default allowable automount directory, before being resolved into fully-qualified paths by the host system (i.e. only fully-resolved absolute pathnames are used in the performance of the actual automatic tape volume mount).

For example, if more than one allowable automount directory is defined and the volume wishing to be mounted happens to reside in the second one, then a fully-qualified absolute pathname should of course be specified (or else one that is relative to the default directory which happens to resolve to the desired file).

All attempts to automount host files in any defined "disallowable" directory (or any sub-directory thereof [or otherwise *not* within any defined "allowable" directory or subdirectory]) will be rejected. An error message is always issued in such cases, just as one is whenever a successful mount or unmount is performed.

A sample guest automount program called TMOUNT for the DOS/VSE operating system is provided in the "util" subdirectory of the distributed source code.

5.8.7 Basic ACF (Automatic Cartridge Feeder) Support

5.8.7.1 Function

The ACF (Automatic Cartridge Feeder) is a feature on cartridge type tape drives (3480, 3490, etc.) that automatically loads a new tape when a tape is removed (ejected) from the drive. There is no real control over this functionality by the host as the device just keeps on feeding tapes one after the other.

Although the ACF features is unique to cartridge type tape systems the emulation accepts to use the same technique for emulated ½ inch tapes reel drives as well. ACF is supported through a file that contains a list of files (emulated tapes or cartridges) that will be loaded one after the other.

To manually reset the ACF to the top of the stack the DEVINIT panel command can be used to "reload" the ACF feature.

5.8.7.2 Syntax

Descriptive

devaddr devtype @filename [arguments]

Diagram

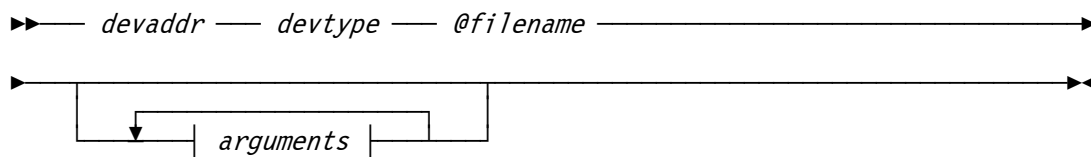

5.8.7.3 Parameter

devaddr This is the device address.

devtype This is the device type. Valid device types are 3410, 3420, 3422, 3430, 3480, 3490, 8809 and 9347.

@filename The filename (without the prefixing '@') contains a list of files that will be loaded one after the other. The filenames contained in the file list cannot describe another ACF file nor an SCSI tape handle (`/dev/stx`). However the files may be standard AWS, HET, Fake Tape or OMA files.

arguments These are the same arguments that apply to the AWS, HET, Fake Tape or OMA files, as described above.

5.8.7.4 Syntax ACF description file

```
# comment line
* arguments
filename [arguments]
```

5.8.7.5 Parameter

The hash symbol starts a comment line.

***** Any options following the asterisk are applied to each file of the list, followed by the options specified on the device configuration entry, followed by the options specified on each individual entry of the file list. Care must be taken that all '*' lines are processed at once.

filename The filename (and path) of the AWS, HET, Fake Tape or OMA tape file.

arguments These are the same arguments that apply to the AWS, HET, Fake Tape or OMA files, as described above. The arguments are processed in the order in which they appear. Any conflicting argument overrides the previous one.

5.8.7.6 Examples

Example 1:

Define a 3490 Automatic Cartridge Feeder (ACF) on device address 0589. ZLIB compression is turned on. The file "newstack" describes a list of tape emulation files to be loaded in succession.

a) Hercules configuration file:

```
0589 3490 @NEWSTACK COMPRESS=1
```

b) "NEWSTACK" file:

```
* MAXSIZEM=16 EOTMARGIN=131072
tape01.aws COMPRESS=0
tape02.het MAXSIZEM=32 EOTMARGIN=65536
tape03.het MAXSIZE=0
```

The above example is equivalent to issuing the following (one at the start and one after each tape unload):

a) in the configuration file:

```
180 3420 tape01.aws maxsizeM=16 eotmargin=131072 compress=0
```

b) via devinit panel command:

```
devinit 180 tape02.het compress=1 maxsizeM=32 eotmargin=65536
devinit 180 tape03.het eotmargin=131072 compress=1 maxsize=0
```

Example 2:

Resolution of the arguments using '*' lines.

The following ACF file

```
* compress=0
tape01.aws
* compress=1
tape02.aws
```

is equivalent to this one

```
* compress=1
tape01.aws
tape02.aws
```

5.9 Channel-to-Channel Adapters

5.9.1 Introduction

The Channel-to-Channel Adapter device statements define CTC adapters to the Hercules configuration. All of the communications emulation implemented within Hercules use a CTCA (Channel-to-Channel Adapter) type device. Depending on the type, the CTCA device will provide either a point-to-point or a virtual network adapter interface to the driving system's TCP/IP stack or in the case of CTCT, a true CTCA connection to another instance of Hercules via a TCP/IP connection.

All current emulations, with the exception of VMNET and CTCT use the Universal TUN/TAP driver on Linux and TunTap32 (WinPCap) on the Windows platforms which creates a network interface on the driving system which allow Hercules to present frames to, and receive frames from the TCP/IP stack. This network interface is configured on Linux platforms by the hercific program which is invoked by Hercules after the TUN/TAP device is opened.

The following are the emulation types currently supported:

- CTCL (Channel-to-Channel link to TCP/IP stack)
- CTCT (Channel-to-Channel emulation via TCP Connection)
- LCS (LAN Channel Station emulation)
- VMNET (Channel-to-Channel link via SLIP/VMNET)

5.9.2 CTCL (Channel-to-Channel link to TCP/IP stack)

5.9.2.1 Function

The CTCL is a point-to-point connection with the TCP/IP stack of the driving system on which Hercules is running.

5.9.2.2 Syntax

Descriptive

```
devaddr CTCL [{-n | --dev} devname]  
                [{-s | --netmask} netmask]  
                [{-m | --macaddr} macaddr | 00:00:5E:nn:nn:nn]  
                [{-t | --mtu} mtu | 1500] *Linux only  
                [{-i | --ibuff} {ibuff | 64}] *Windows only  
                [{-k | --kbuff} {kbuff | 1024}] *Windows only  
                [-d | --debug]  
guestip hostip
```

Diagram

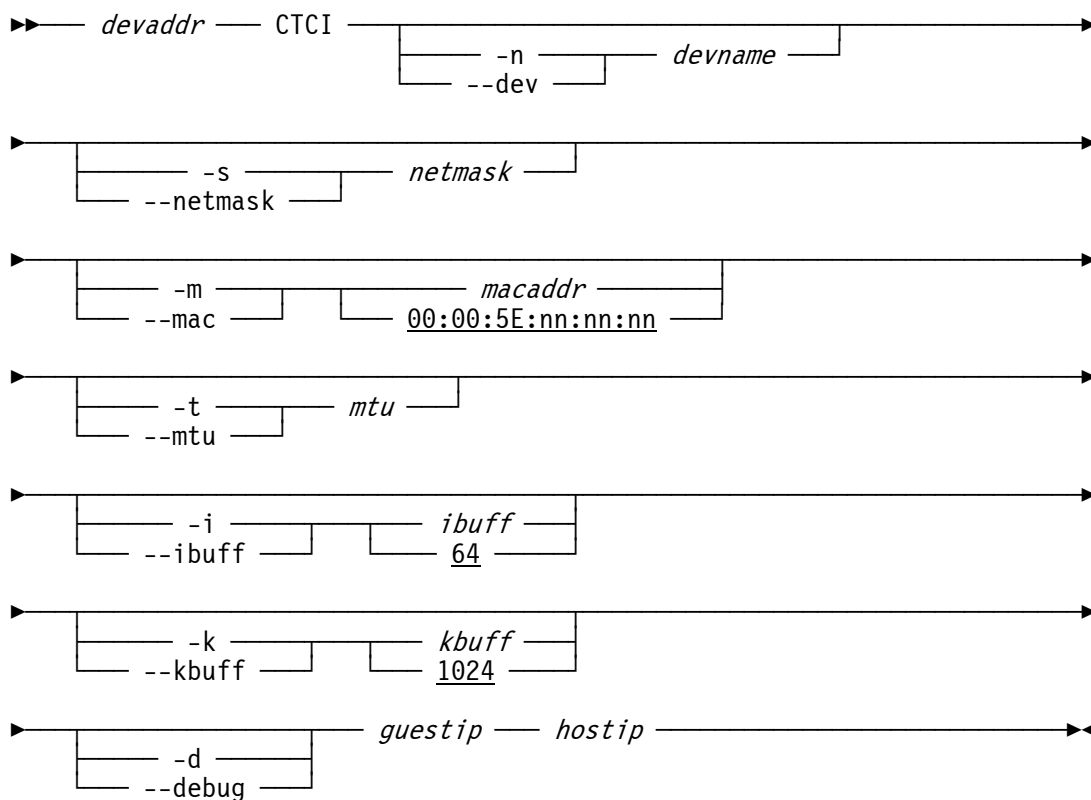

5.9.2.3 Parameter

devaddr This is the device address.

CTCI This specifies the device/protocol type.

-n devname For Linux: Specifies the name of the tunnel device to use. The default is “/dev/net/tun”, which is correct for version 2.4 and above of the Linux kernel.

For Windows: Identifies the host network adapter. If your network adapter does not have a permanent (static) IP address assigned to it (e.g. you use DHCP and have a dynamic IP assigned) then instead of specifying an IP address as the second parameter in the device statement, you must specify the MAC address of the adapter. In this case the second argument (hostip) must be coded as “0.0.0.0”. This is simply a placeholder because two IP addresses are expected to satisfy the device definition syntax.

--dev devname This is the same as “-n devname”.

-s netmask This is the netmask to be configured on the link. Note: Since this is a point-to-point link netmask is meaningless from the perspective of the actual network device.

--netmask netmask This is the same as “-s netmask”.

--m macaddr This is the optional hardware address of the interface in the format of either “xx:xx:xx:xx:xx:xx” or “xx-xx-xx-xx-xx-xx”. The default is 00:00:5E:nn:nn:nn where the “nn:nn:nn” part is constructed from the last three octets of the specified guestip.

--macaddr macaddr This is the same as “-m macaddr”.

-t mtu	Linux only: Specifies the maximum transmission unit size (default 1500 bytes).
--mtu mtu	This is the same as “-t mtu”.
-i ibuff	Windows only: This specifies the TunTap32 I/O buffer size in KB. <i>nnnn</i> has to be between 16 and 1024 (1 MB). The default value is 64 KB.
--ibuff ibuff	This is the same as “-i ibuff”.
-k kbuff	Windows only: This specifies the WinPcap device driver capture buffer size in KB. <i>nnnn</i> has to be between 64 and 16384 (16 MB). The default value is 1024 (1 MB).
--kbuff kbuff	This is the same as “-k kbuff”.
-d	Specifies that debugging output has to be produced on the Hercules control panel. This should normally be left unspecified.
--debug	This is the same as “-d”.
guestip	Specifies the IP address of the guest operating system running under Hercules.
hostip	Identifies the host network adapter to use. If the host system is configured with DHCP this should instead be the MAC address of the ethernet adapter you wish to have Hercules use to connect to the outside world. If this parameter is specified using the <i>-m</i> or <i>--dev</i> option, then the value here must be specified as "0.0.0.0" to satisfy the statement syntax.

5.9.2.4 Examples

Example 1:

Define 3088 CTC adapters on device addresses 0E20 and 0E21. The device/protocol type is CTCI (Channel-to-Channel link to Linux TCP/IP stack). The IP address of the guest operating system running under Hercules is 192.168.1.99, the host IP address (the network adapter) to use is 192.168.1.100.

```
0E20 3088 CTCI 192.168.1.99 192.168.1.100
0E21 3088 CTCI 192.168.1.99 192.168.1.100
```

Example 2:

Define 3088 CTC adapters on device addresses 0E20 and 0E21. The device/protocol type is CTCI (Channel-to-Channel link to Win32 TCP/IP stack). The WinPcap device driver capture buffer has to be set to 2048 KB, the TunTap32 I/O buffer size has to be set to 128 KB. The IP address of the guest operating system running under Hercules is 192.168.1.99 and the MAC address of the network adapter to use is 00-80-B3-E1-DF-69.

```
0E20 3088 CTCI -n 00-80-B3-E1-DF-69 -k 2048 -i 128 192.168.1.99 0.0.0.0
0E21 3088 CTCI -n 00-80-B3-E1-DF-69 -k 2048 -i 128 192.168.1.99 0.0.0.0
```

5.9.3 CTCT (Channel-to-Channel emulation via TCP Connection)

5.9.3.1 Function

This is an emulated Channel-to-Channel adapter to another Hercules system. CTCT only supports IP traffic and cannot be used to transport NJE, SNA, PVM, etc. type payloads. This may change in the future.

5.9.3.2 Syntax

Descriptive

devaddr CTCT lport rhost rport bufsize

Diagram

▶— *devaddr* — CTCT — *lport* — *rhost* — *rport* — *bufsize* —▶

5.9.3.3 Parameter

devaddr	This is the device address.
CTCT	This specifies the device/protocol type.
lport	Specifies the local TCP port. This is the TCP port that Hercules will listen on for this CTC adapter.
rhost	Specifies the remote host. This is the name or IP address of the remote host system that Hercules is running on, not the name or IP address of the OS running under this instance of Hercules.
rport	Specifies the remote TCP port. The rport parameter on this system must match the lport parameter on the remote system and vice versa.
bufsize	Specifies the buffer size for the link. If this link is used for IP traffic this parameter should be more than the MTU of the interface definition in the OS TCPIP stack.

5.9.3.4 Examples

Example 1:

Define 3088 CTC adapters on device addresses 0400 and 0401. The device/protocol type is CTCT (Channel-to-Channel emulation via TCP connection). The local TCP ports on which Hercules will listen are 30880 and 30881. The IP address of the remote host is 192.168.100.2, the remote ports are also 30880 and 30881. The buffer size for the link is 2048 KB.

```
0400 3088 CTCT 30880 192.168.100.2 30880 2048
0401 3088 CTCT 30881 192.168.100.2 30881 2048
```

5.9.4 LCS (LAN Channel Station)

5.9.4.1 Function

This statement defines an emulated LAN Channel Station adapter. This emulation mode appears to the operating system running in the Hercules machine as an IBM 8232 LCS device, an IBM 2216 router, an IBM 3172 running ICP (Interconnect Communications Program), the LCS3172 driver of an IBM P/390, or an IBM Open Systems Adapter (OSA).

Rather than a point-to-point link, this emulation creates a virtual ethernet adapter through which the guest operating system running in the Hercules machine can communicate. As such, this mode is not limited to TCP/IP traffic, but in fact will handle any ethernet frame.

5.9.4.2 Syntax

Descriptive

```
devaddr LCS [{-n | --dev} devname]
            [{-o | --oat} file]
            [{-m | --mac} macaddr]
            [-d | --debug]
            [guestip]
```

Diagram

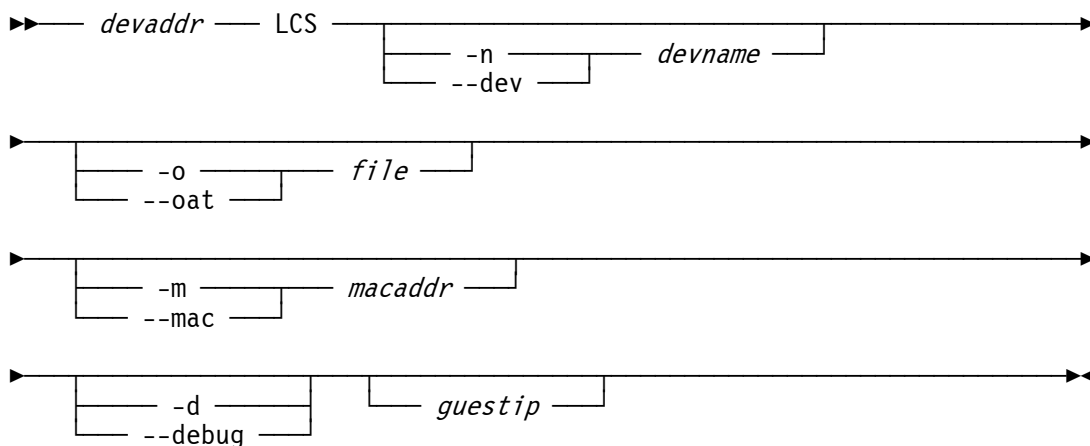

5.9.4.3 Parameter

devaddr This is the address pair of the LCS device. This pair must be an even-odd address. This can be specified as two separate LCS statements with a single device address ("0E20 LCS ...") or as a single statement with a device address count ("0E20.2 LCS ...").

LCS This specifies the LAN Channel Station device/protocol type.

-n devname Identifies the host network adapter to use:
 - On Linux systems this is name of the TUN/TAP special character device, normally /dev/net/tun.
 - On Windows this is either the IP or MAC address of the host systems network card. TunTap32 will automatically select the first network adapter it finds if the option is omitted, this may be not desirable for some users.

--dev devname This is the same as "-n devname".

- o file** *file* specifies the filename of the Address Translation file. If this option is specified the optional *--mac* and *guestip* entries are ignored in preference to statements in the OAT file. For a description of the OAT file see next section.
- oat file** This is the same as “-o file”.
- m macaddr** *macaddr* is the optional hardware address of the interface in the format xx:xx:xx:xx:xx:xx. If you use the -o/--oat option do not specify an address here, it will be ignored.
- mac macaddr** This is the same “-m macaddr”.
- d** Specifies that debugging output has to be produced on the Hercules control panel. This should normally be left unspecified.
- debug** This is the same as “-d”.
- guestip** This is an optional IP address of the Hercules (guest OS) side. This is only used to establish a point-to-point routing table entry on the driving system. If you use the --oat option do not specify an address here, it will be ignored.

5.9.4.4 OAT File Syntax

The syntax for the Address Translation file is as follows:

```

*****
* Dev   Mode  Port  Entry specific information...
*****
0400  IP    00    PRI  172.021.003.032
0402  IP    00    SEC  172.021.003.033
0404  IP    00    NO   172.021.003.038
0406  IP    01    NO   172.021.002.016
040E  SNA   00

HWADD 00  02:00:FE:DF:00:42
HWADD 01  02:00:FE:DF:00:43
ROUTE 00  172.021.003.032  255.255.255.224

```

Figure 2: OAT File Syntax

- Dev** This is the base device address.
- Mode** This is the operation mode: IP or SNA. (Note: The SNA operation mode is currently not implemented.)
- Port** This is the virtual (relative) adapter number.
- Entry** This applies only for IP Mode and specifies where a packet with an unknown IP address is forwarded. PRI is the primary default entry, SEC is the entry to use when the primary is not available and NO specifies that this is not a default entry.
- n.n.n.n** This specifies the home IP address.

When the operation mode is IP specify only the even (read) device number *dev*. The odd (write) address will be created automatically. Additionally two other statements can be included in the Address Translation file. These are the HWADD and ROUTE statements.

Use the HWADD statement to specify a hardware (MAC) address for a virtual adapter. The first parameter after the HWADD specifies the relative adapter for which the address is applied.

The ROUTE statement is included for convenience. It allows the hercific program to create a network route for this specific virtual adapter. Please note that it is not necessary to include point-to-point routes for each IP address in the table. This is done automatically by the emulation module.

The read / write devices can be swapped by coding the odd address of the even-odd pair in the OAT. Up to 4 virtual (relative) adapters (00-03) are currently supported.

If no Address Translation file is specified, the emulation module will create the following:

- An ethernet adapter (port 0) for TCP/IP traffic only.
- Two device addresses (devnum and devnum+1).

5.9.4.5 Examples

Example 1:

Define LCS (LAN Channel Station emulation) adapters on device addresses 0440 and 0441. The name of the TUN/TAP special character device is "/dev/net/tun". The IP address of the Hercules guest OS side is 192.168.200.2.

```
0440.2 LCS -n /dev/net/tun 192.168.200.2
```

5.9.5 VMNET (Channel-to-Channel link via SLIP/VMNET)

5.9.5.1 Function

If the emulation mode is not specified on the configuration statement, it is assumed to be a point-to-point link to the driving system's TCP/IP stack using Willem Konynenberg's VMNET package. This provides the same function as the CTCL mode of operation, except that it uses a virtual SLIP interface instead of the TUN/TAP driver.

5.10 FBA DASD Devices

5.10.1 Function

This device statement is used to define a FBA DASD device to the Hercules configuration. The argument specifies the name of a file which contains the FBA DASD image or the INET address of a Hercules shared device server.

The file consists of fixed length 512-byte records each of which represents one physical block of the emulated disk. To allow access to a minidisk within a full-pack FBA DASD image file two additional arguments (origin and numblks) may be specified after the filename.

5.10.2 Syntax

Descriptive

```
devaddr devtype filename [origin | 0] [numblks] [sf=shadowfile] [SYNCIO]
```

or

```
devaddr devtype ipname [:port | :3990] [:devnum] [COMP=n]
```

Diagram

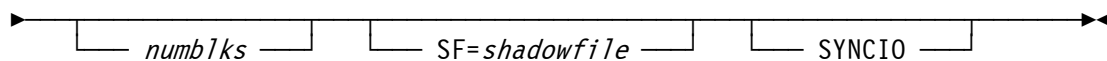
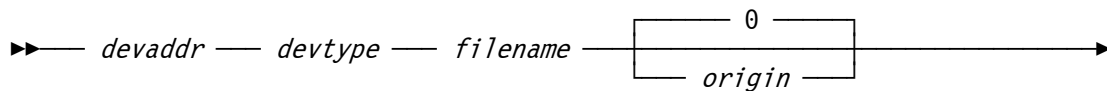

or

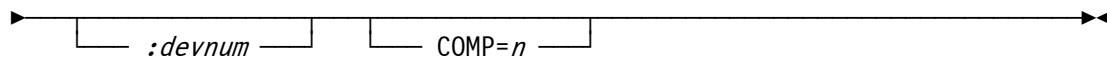
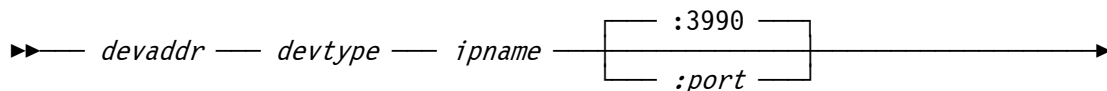

5.10.3 Parameter

devaddr This is the device address.

devtype This is the device type. Valid device types are 3310, 3370, 9332, 9335, 9336 and 0671.

filename	This specifies the filename (and path) of the file containing the DASD image.
origin	This defines the relative block number within the DASD image file at which the minidisk begins. The number must be less than the number of blocks in the file. The default origin is zero.
numblks	Specifies the number of 512-byte blocks in the minidisk. This number must not exceed the number of blocks in the file minus the origin. If omitted or specified as an asterisk ("*"), then the minidisk continues to the end of the DASD image file.
shadowfile	The handling of shadow files for FBA devices is identical as that for CCKD devices. Please refer to the following CCKD section for information regarding the use of the SF=shadow file option.
SYNCIO	SYNCIO enables possible synchronous I/O and is explained in detail in the following CKD DASD section.
ipname	This is the host name or IP address of the system, where the Hercules shared device server is running.
port	This is the port number the shared device server is listening on. If omitted the default is 3990.
devnum	Devnum specifies the device number on the shared device server. If omitted the default is the current device number on the local system.
COMP=n	This keyword requests that the data has to be transferred compressed between the client and the server. The argument <i>n</i> specifies the compression level (1-9). A value closer to 1 means less compression but also less processor time to perform the compression. A value closer to 9 means the data is compressed more but also more processor time is required to compress the data.

5.10.4 Examples

Example 1:

Define a 3310 FBA DASD device on device address 0120. The name and path of the file containing the DASD image is "D:/DASD/TST001.FBA".

```
0120 3310 D:/DASD/TST001.FBA
```

Example 2:

Define a 3370 FBA DASD device on device address 0120. The DASD device is attached to a shared device server which is running on a machine with IP address 192.168.200.1 and listening on port 3990. The device address of the DASD on the shared device server is 0121.

```
0120 3370 192.168.200.1:3990:0121
```

5.11 CKD DASD Devices

5.11.1 Function

This device statement is used to define a CKD DASD device to the Hercules configuration. The argument specifies the name of a file that contains the CKD DASD image or the INET address of a Hercules shared device server.

The file consists of a 512-byte device header record followed by fixed length track images. The length of each track image depends on the emulated device type and is always rounded up to the next multiple of 512 bytes.

Volumes larger than 2 GB (for example the 3390, model 3) can be supported by spreading the data across more than one file. Each file contains a whole number of cylinders. The first file (which contains cylinders 0-2518 in the case of a 3390) usually has “_1” as the last two characters of its name. The ckddasd driver allocates the remaining files by replacing the last characters of the file name by the characters “_2”, “_3” and so on.

If your operating system supports large file sizes (or 64-bit offsets) then volumes larger than 2GB can be kept in a single file. The two character suffix is not used in this case.

Alternatively the argument may specify the name of a file containing a compressed CKD DASD image (CCKD DASD files). The CKD driver will automatically detect whether the file contains a regular CKD image or a compressed CKD image.

5.11.2 Syntax

Descriptive

```
devaddr devtype filename [sf=shadowfile] [NOSYNCIO | SYNCIO] [READONLY]
                               [FAKEWRITE] [CU=type]
```

or

```
devaddr devtype ipname [ :port | :3990 ] [ :devnum ] [COMP=n]
```

Diagram

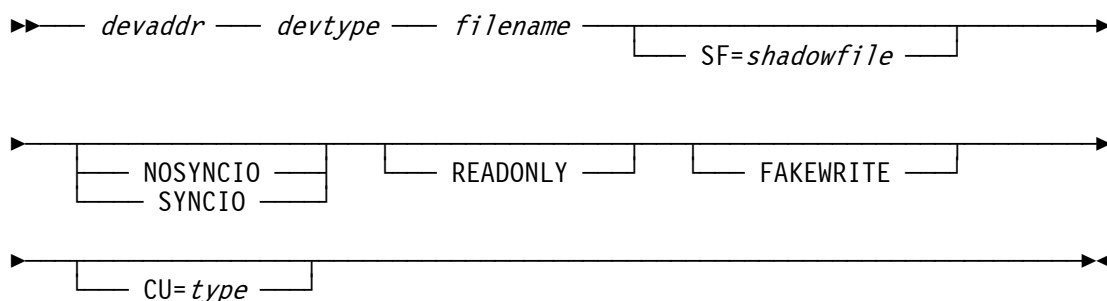

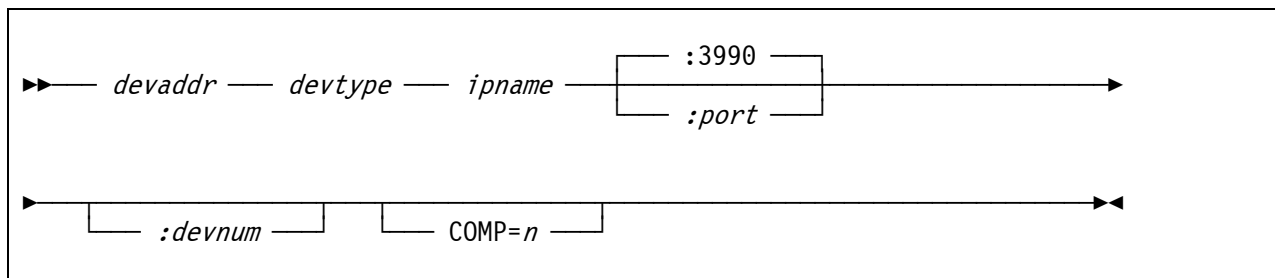

5.11.3 Parameter

- devaddr** This is the device address.
- devtype** This is the device type. Valid device types are 2311, 2314, 3330, 3350, 3375, 3380, 3390 and 9345.
- filename** This specifies the filename (and path) of the file containing the DASD image.
- shadowfile** A shadow file contains all the changes made to the emulated DASD device since it was created, maintained until the next shadow file is created. The moment of the shadow file's creation can be thought of a snapshot of the current emulated DASD at that time, as if the shadow file is later removed the emulated DASD reverts back to the state it was when the snapshot was taken.

Using shadow files, the base files can be kept on a read-only device like CDROM or can be defined as read-only thus ensuring that these files can never be corrupted.

The shadow file does not have to actually exist when it is defined in the configuration file. The *shadow* operand of the *sf=* parameter is simply a filename template that will be used to name the shadow file whenever one is be created. Shadow files are created using the *sf+ xxxx* or *sf+ ** commands.

The shadow file name must have a position where the shadow file number will be set. This is either the character preceeding the last period after the slash or the last character if there is no period. For example: *sf=shadows/linux1_*.dsk*.

Hercules console commands are provided to add a new shadow file, remove the current shadow file (with or without backward merge), compress the current shadow file and display the shadow file status and statistics.

Please note, that the "sf" parameter has to be coded in lowercase letters otherwise an error message is presented ("HHCDA003E parameter 2 is invalid: SF=...").

Details on how to work with shadow files can be found in chapter 7.94 ff.

- [NO]SYNCIO** SYNCIO enables possible "synchronous" I/O. This is a DASD I/O feature wherein guest I/O requests are completed "synchronously" during the actual emulated execution of the SIO / SSCH (START IO / START SUBCHANNEL) instructions rather than being deferred and executed asynchronously in a separate device I/O thread.

Only I/O which are known to be able to be completed without actually needing to perform any actual host I/O are completed synchronously (e.g. whenever the data being requested is found already be in the cache). If the requested data is not found in the cache then actual host I/O will need to be done and the request is passed to a device I/O thread to be completed asynchronously instead.

SYNCIO is the default for CKD devices. SYNCIO statistics may be displayed via the Hercules SYNCIO console command. SYNCIO may be abbreviated as SYIO.

Note: If you plan on using SYNCIO with Linux/390 and/or zLinux you might also want to take a look at the IODELAY configuration statement as well.

READONLY READONLY returns “write inhibited” sense when a write is attempted. Note that not all the sense bits may be set absolutely correctly.

FAKEWRITE FAKEWRITE is a workaround for the READONLY sense problem mentioned above. In these cases the disk is not intended to be updated (e.g. MVS updates the DSCB last referenced field for a readonly file) and any writes appear to be successful even though nothing is actually written.

type Specifies the type of control unit to which this device is attached. The use of this parameter does not necessarily imply that all functions of the specified control unit are emulated. The purpose is to force a particular control unit type to be indicated in the data returned by SENSE ID and similar CCW's.

Normally the default value is appropriate and this parameter need not to be specified. Additional to the table below the following values may be specified: 3990-3 and 3990-6.

The default value depends on the device type:

Device Type	Default CU Type
2311	2841
2314	2314
3330, 3340, 3350, 3375, 3380	3880
3390	3990
9345	9343

Table 6: Default CU Types

ipname This is the host name or IP address of the system where the Hercules shared device server is running.

port This is the port number the shared device server is listening on. If omitted the default is 3990.

devnum Devnum specifies the device number on the shared device server. If omitted the default is the current device number on the local system.

COMP=n This keyword requests that the data has to be transferred compressed between the client and the server. The argument *n* specifies the compression level (1-9). A value closer to 1 means less compression but also less processor time to perform the compression. A value closer to 9 means the data is compressed more but also more processor time is required to compress the data.

Two other options *LAZYWRITE* and *FULLTRACKIO* have been deprecated. They are still accepted to support compatibility with older configuration files but do nothing. It is strongly recommended to remove these statements from the configuration file.

5.11.4 Examples

Example 1:

Define a 3390 CKD DASD device on device address 0A8C. The name and path of the file containing the DASD image is "D:/DASD/SARES1.CKD".

```
0A8C 3390 D:/DASD/SARES1.CKD
```

Example 2:

Define a 3390 CKD DASD device on device address 0AA2. The name and path of the file containing the DASD image is "D:/DASD/SARES1.CKD". Synchronous I/O has to be enabled and the device has to return the "write inhibited" sense when a write is attempted.

```
0AA2 3390 D:/DASD/SARES1.CKD SYNCIO READONLY
```

Example 3:

Define a 3390 CCKD DASD device on device address 0A00. The name and path of the file containing the DASD image is "D:/DASD/SARES1.CCKD". All changes to the DASD device have to go to the shadow file(s) "D:/SHADOW/SARES1_*.CCKD".

```
0A00 3390 D:/DASD/SARES1.CCKD SF=D:/SHADOW/SARES1_*.CCKD
```

Example 4:

Define a 3390 CKD DASD device on device address 0A8C. The DASD device is attached to a shared device server which is running on a machine with IP address 192.168.200.1 and listening on port 3990. The device address of the DASD on the shared device server is also 0A8C.

```
0A8C 3390 192.168.200.1:3990:0A8C
```

5.12 Communication Lines (Preliminary 2703 BSC Support)

5.12.1 Function

This statement describes a BSC emulation line entry to either link 2 Hercules engines or a custom made program emulating a 2780, 3780 or 3x74, or a custom made program interfacing to a real BSC line.

The communication is emulated over a TCP connection. All bytes are transferred as-is (except for doubling DLE in transparent mode) just as over a real BSC link. Emulated EIA (DCD, DTR, CTS, etc.) or X.21/V.11 leads (C, T, etc.) are treated differently depending on the DIAL option selected.

The line emulates a point-to-point BSC link. There is no point-to-multipoint handling.

5.12.2 Syntax

Descriptive

```
devaddr devtype DIAL={IN | OUT | INOUT | NO}
                LHOST={hostname | ipaddress | *} LPORT={servicename | port}
                RHOST={hostname | ipaddress } RPORT={servicename | port}
                [RTO={0 | -1 | nnn | 3000}]
                [PTO={0 | -1 | nnn | 3000}]
                [ETO={0 | -1 | nnn | 10000}]
```

Diagram

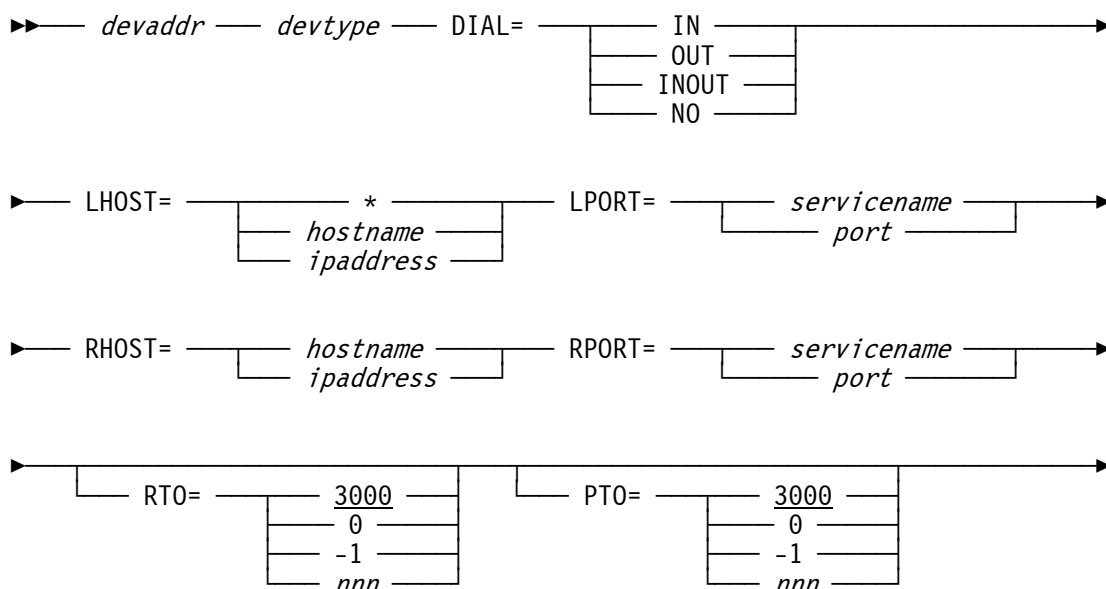

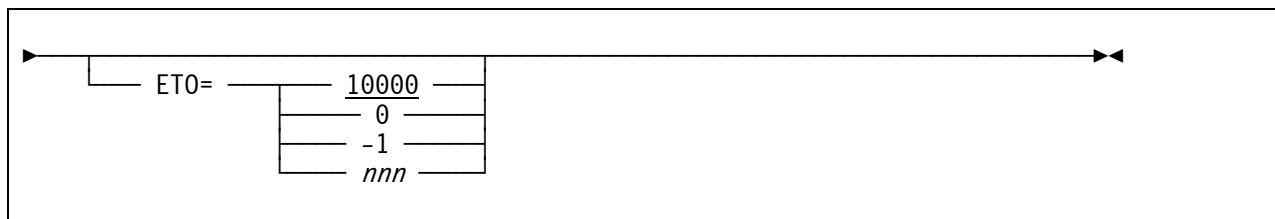

5.12.3 Parameter

devaddr	This is the device address.
devtype	This is the device type. A valid device type is 2703.
DIAL	This specifies the call direction (if any). If DIAL=NO is specified the TCP outgoing connection is attempted as soon as an ENABLE CCW is executed. Also in this mode, an incoming connection will always be accepted. If DIAL=IN or INOUT is specified a TCP incoming call is accepted only if an ENABLE CCW is currently executing on the device. With DIAL=OUT the ENABLE CCW is rejected. When DIAL=IN or INOUT is coded a DIAL CCW allows the application to establish a TCP connection to a specific host. For other DIAL values the DIAL CCW is rejected.
LHOST	Specifies which IP address to listen on. This also conditions the network interface from which incoming calls will be accepted. An asterisk (“*”) means all incoming TCP calls are accepted regardless of the destination IP address or call origin. A given IP address when DIAL=OUT is specified has no effect.
LPORT	Specifies the TCP port for which to listen to incoming TCP calls. This value is mandatory for DIAL=IN, DIAL=INOUT or DIAL=NO. It is ignored for DIAL=OUT.
RHOST	Specifies the remote host to which to direct a TCP connection on a DIAL=NO line when an ENABLE CCW is executed. This value is mandatory when DIAL=NO is specified, It is ignored for other DIAL values.
RPORT	Specifies the remote port to which to direct a TCP connection on a DIAL=NO line when an ENABLE CCW is executed. This value is mandatory when DIAL=NO is specified, It is ignored for other DIAL values.

The following arguments are tuning options. In most cases using the default values will give the best result.

RTO	Specifies the number of milliseconds before terminating a read on a timeout when no read termination control character is received. A value of zero means the read ends immediately. “-1” specifies that there is no timeout.
PTO	Specifies the number of milliseconds before terminating a POLL on a timeout when no ACK or NACK sequence is received. A value of zero means the POLL ends immediately. “-1” specifies that there is no timeout.
ETO	Specifies the number of milliseconds before terminating an ENABLE operation on a timeout. The timeout applies when DIAL=NO, DIAL=IN or DIAL=INOUT is specified, the outgoing TCP call fails (DIAL=NO) and there is no previously or currently established TCP connection for this line. When DIAL=NO is specified the timeout defaults to 10 seconds, for DIAL=IN or DIAL=INOUT, the timeout defaults to “-1”, meaning there is no timeout.

5.12.4 Examples

Example 1:

Define 2703 BSC emulation line on device address 0023. The outgoing connection should be attempted as soon as an ENABLE CCW is expected, incoming connections should always be accepted (DIAL=NO). The IP address to listen on is 127.0.0.1 with port 3780. The remote port to which to direct a TCP connection is 3781.

```
0023 2703 DIAL=NO LHOST=LOCALHOST LPORT=3780 RPORT=3781
```

6. Hercules Console

6.1 Hercules Hardware Console

Various aspects of Hercules can be controlled with console commands. These commands are entered from the command line of the Hercules hardware management console (HMC).

The Hercules hardware management console window is the panel that is active by default after starting Hercules. An alternate semi-graphical "New Panel" display showing devices, registers etc. is also available. Pressing the escape key switches between the two panels.

The main Hercules screen contains a scrollable list of messages with a command input area and a system status line at the bottom of the screen. To scroll through the messages, use either the Page Up or Page Down keys, the Ctrl + Up Arrow or Ctrl + Down Arrow keys, or the Home or End and/or the Ctrl + Home or Ctrl + End keys.

Important messages are highlighted in a different color (usually red) and are prevented from being scrolled off the screen for two minutes. If Extended Cursor handling is available then important messages currently at the top of the screen can be removed early by moving the cursor to the line containing the message and then pressing enter.

Use the Insert key to switch between insert and overlay mode when typing in the command input area. Use the Home and End keys to move to the first or last character of the command you are typing, or the use the left/right arrow keys to move to a specific character. Use the Escape key to erase the input area.

When a command is prefixed with '-', the command will not be redisplayed at the console. This can be used in scripts and is also used internally when commands are to be invoked without being redisplayed at the console.

Pressing "Escape" when the command input area is already empty causes the screen to switch to the semi-graphical "New Panel" display mode, which shows the overall status of the system and devices.

When in the semi-graphical "New Panel" display mode there is no command input area. Instead, single character "hot keys" are used to issue some of the more common functions such as starting or stopping the CPU. The hot-keys are those which are highlighted. Pressing the '?' key displays brief help information on how to use the semi-graphical panel.

Sample windows are shown in the pictures on the following pages.

```

Hercules Emulator HMC - MVS V3.8J
Hercules Version 3.07
(c)Copyright 1999-2010 by Roger Bowler, Jan Jaeger, and others
Built on Mar 23 2010 at 01:41:44
Build information:
  Windows (MSUC) build for AMD64
  Modes: S/370 ESA/390 z/Arch
  Max CPU Engines: 8
  Using fthreads instead of pthreads
  Dynamic loading support
  Using shared libraries
  HTTP Server support
  No SIGABEND handler
  Regular Expressions support
  Automatic Operator support
  Machine dependent assists: cmpxchg1 cmpxchg4 cmpxchg8
Running on GOOPY Windows_NT-6.1 AMD64 MP=8
HHCHD018I Loadable module directory is hercules
Crypto module loaded (c) Copyright Bernard van der Helm, 2003-2010
  Active: Message Security Assist
         Message Security Assist Extension 1
         Message Security Assist Extension 2
HHCCF077I Engine 0 set to type 0 (CP)
HHCCF077I Engine 1 set to type 0 (CP)
HHCCF077I Engine 2 set to type 0 (CP)
HHCCF077I Engine 3 set to type 0 (CP)
HHCCF081I D:/MUS/CONF/MUS38J.CONF Will ignore include errors .
HHCPM197I Log option set: TIMESTAMP
HHCHT001I HTTP listener thread started: tid=00000B7C, pid=3984
HHCHT013I Using HTTPROOT directory "D:\Hercules\html\"
HHCCF020W Vector Facility support not configured
HHCHT006I Waiting for HTTP requests on port 8089
HHCCF065I Hercules: tid=00000F74, pid=3984, ppid=3984, priority=0
HHCS0041 Device 000E bound to socket 192.168.0.101:14031
HHCS0020I Socketdevice listener thread started: tid=00000C40, pid=3984
HHCS0041 Device 000F bound to socket 192.168.0.101:14032
HHCTE001I Console connection thread started: tid=00000E50, pid=3984
HHCTE003I Waiting for console connection on port 3278
HHCDA020I D:/MUS/DASD/SORT00.CCKD cyls=200 heads=20 tracks=4000 trklen=7680
HHCDA020I D:/MUS/DASD/SORT01.CCKD cyls=200 heads=20 tracks=4000 trklen=7680
HHCDA020I D:/MUS/DASD/SORT02.CCKD cyls=203 heads=20 tracks=4060 trklen=7680
HHCDA020I D:/MUS/DASD/SORT03.CCKD cyls=200 heads=20 tracks=4000 trklen=7680
HHCDA020I D:/MUS/DASD/SORT04.CCKD cyls=200 heads=20 tracks=4000 trklen=7680
HHCDA020I D:/MUS/DASD/SORT05.CCKD cyls=200 heads=20 tracks=4000 trklen=7680
HHCDA020I D:/MUS/DASD/WORK00.CCKD cyls=555 heads=30 tracks=16650 trklen=1945
HHCDA020I D:/MUS/DASD/WORK01.CCKD cyls=555 heads=30 tracks=16650 trklen=1945
HHCDA020I D:/MUS/DASD/PRD000.CCKD cyls=560 heads=30 tracks=16800 trklen=1945
HHCDA020I D:/MUS/DASD/PRD001.CCKD cyls=560 heads=30 tracks=16800 trklen=1945
HHCDA020I D:/MUS/DASD/PRD002.CCKD cyls=560 heads=30 tracks=16800 trklen=1945
HHCDA020I D:/MUS/DASD/PRD003.CCKD cyls=560 heads=30 tracks=16800 trklen=1945
HHCDA020I D:/MUS/DASD/MUSRES.CCKD cyls=560 heads=30 tracks=16800 trklen=1945
HHCDA020I D:/MUS/DASD/MUSDLB.CCKD cyls=555 heads=30 tracks=16650 trklen=1940
Command ==>
CPU0000 PSW=0000000000000000 24M..... instcount=0

```

Figure 3: Hercules Hardware Console

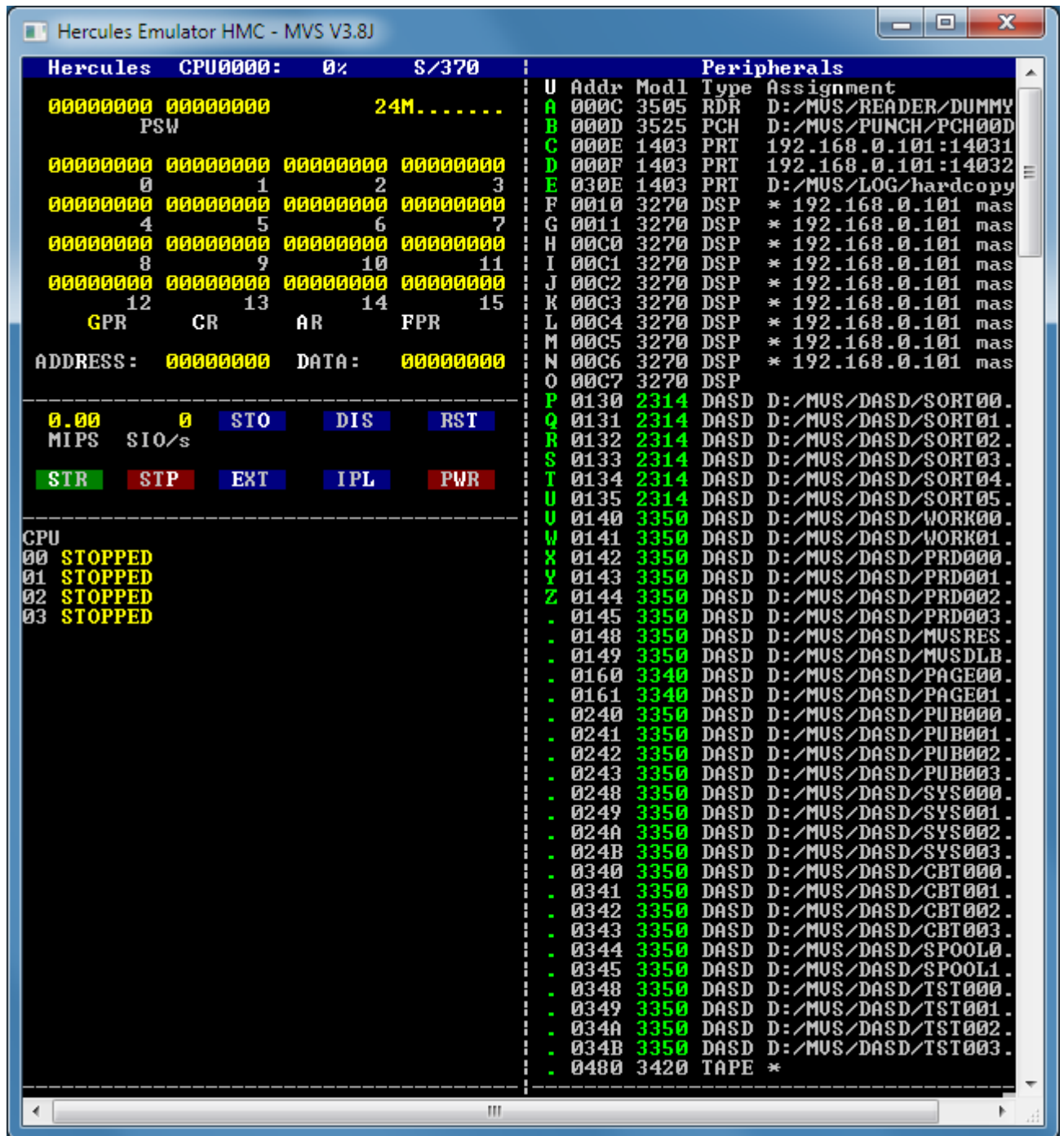

Figure 4: Hercules device and status panel

6.2 Web browser interface

It is not necessary to work directly on the PC where Hercules is running to enter the console commands. Instead of using the hardware management console on the Hercules server itself it is possible to work from a browser interface in a web browser.

The requirement to be able to work with the web browser interface is a running Hercules HTTP server. The HTTP server is started through the HTTPPORT and HTTPROOT configuration statements. For details on configuring the HTTP server please see section "System Parameter Descriptions".

Once the HTTP server is started, the interface can be used from a web browser on any machine, that has a network connection to the Hercules server. With this interface you can operate Hercules nearly in the same way as you would do locally on the hardware management console.

The following picture shows the main panel of the web browser interface.

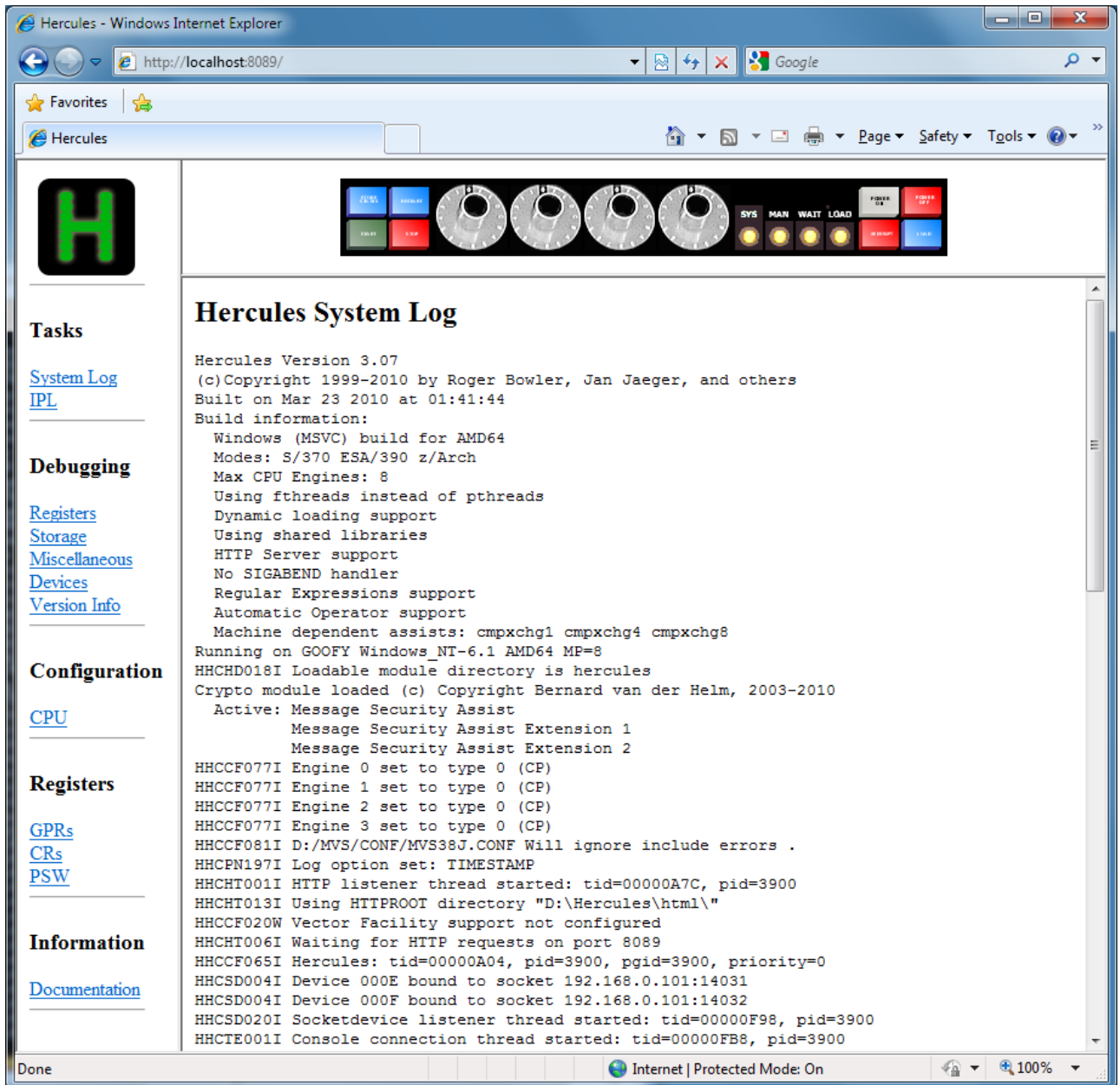

Figure 5: Hercules web browser interface

6.3 Using the keyboard

The usage of the keyboard in the Hercules hardware management console is distinguished between normal cursor handling and extended cursor handling.

6.3.1 Normal cursor handling

The normal cursor handling is available on all platforms (Windows and Unix).

Normal cursor handling	
Key	Action
Esc	Erases the contents of the command input area. If the command input area is already empty, switches to semi-graphical New Panel.
Del	Deletes the character at the cursor position.
Backspace	Erases the previous character.
Insert	Toggles between insert mode and overlay mode.
Tab	Attempts to complete the partial file name at the cursor position in the command input area. If more than one possible file exists, a list of matching file names is displayed.
Home	Moves the cursor to the start of the input in the command input area. If the command input area is empty, scrolls the message area to the top.
End	Moves the cursor to the start of the input in the command input area. If the command input area is empty, scrolls the message area to the bottom.
Page Up	Scrolls the message area up one screen.
Page Down	Scrolls the message area down one screen.
Up arrow	Recalls the previous command into the input area.
Down arrow	Recalls the next command into the input area.
Right arrow	Moves cursor to the next character of the input area.
Left arrow	Moves cursor to the previous character of the input area.
Ctrl + Up arrow	Scrolls the message area up one line.
Ctrl + Down arrow	Scrolls the message area down one line.
Ctrl + Home	Scrolls the message area to the top.
Ctrl + End	Scrolls the message area to the bottom.

Table 7: Normal cursor handling

6.3.2 Extended cursor handling

The following additional keyboard functions are effective when the Hercules Extended Cursor Handling feature (OPTION_EXTCURS) is activated at compile time. At present, this feature is activated on the Windows platform only.

Extended cursor handling	
Key	Action
Alt + Up arrow	Moves cursor up one row.
Alt + Down arrow	Moves cursor down one row.
Alt + Right arrow	Moves cursor right one column.
Alt + Left arrow	Moves cursor left one column.
Tab	If the cursor is outside the command input area, moves cursor to the start of the input in the command input area. Otherwise behaves like as described in the previous table.
Home	If the cursor is outside the command input area, moves cursor to the start of the input in the command input area. Otherwise behaves like as described in the previous table.
End	If the cursor is outside the command input area, moves cursor to the end of the input in the command input area. Otherwise behaves like as described in the previous table.

Table 8: Extended cursor handling

6.4 Log formats

The appearance of the log in terms of prefixing the messages is dependent on the used environment. The most flexible ways of prefixing the messages is given when running Hercules using the WinGUI. Running Hercules with the native console gives only limited options. The following table show an overview of the log options, depending on the Hercules version used.

Message Prefix	Native Hercules Console	Hercules with WinGUI
Date	No	Yes
Time	Yes	Yes
Process ID	No	Yes
Prefix(es) visible on console	No	Yes
Prefix(es) visible on hardcopy log	Yes	Yes

Table 9: Message prefix overview

Most of the console command examples in this book are made using the WinGUI as described below. In some examples the log options have been reduced to fit one log line into the example boxes in the manual.

6.4.1 Hercules Console

Using Hercules under Linux, Mac OS or Windows (without WinGUI) lets you prefix the console messages with a timestamp. The difference between these options is shown in the next figure. Switching the option can be done with the `logopt` console command or can be set at startup time through the `logopt` system parameter.

Please note that the console itself does not show the timestamp, independent of the `logopt` settings. Only the hardcopy log does show the timestamp.

```
.
.
.
logopt notimestamp
HHCPN197I Log option set: NOTIMESTAMP
gpr
CPU0000: R0=0000000000000000 R1=0000000000000000
CPU0000: R2=0000000000000000 R3=0000000000000000
CPU0000: R4=0000000000000000 R5=0000000000000000
CPU0000: R6=0000000000000000 R7=0000000000000000
CPU0000: R8=0000000000000000 R9=0000000000000000
CPU0000: RA=0000000000000000 RB=0000000000000000
CPU0000: RC=0000000000000000 RD=0000000000000000
CPU0000: RE=0000000000000000 RF=0000000000000000
23:01:32 logopt timestamp
23:01:32 HHCPN197I Log option set: TIMESTAMP
23:01:36 gpr
23:01:36 CPU0000: R0=0000000000000000 R1=0000000000000000
23:01:36 CPU0000: R2=0000000000000000 R3=0000000000000000
23:01:36 CPU0000: R4=0000000000000000 R5=0000000000000000
23:01:36 CPU0000: R6=0000000000000000 R7=0000000000000000
23:01:36 CPU0000: R8=0000000000000000 R9=0000000000000000
23:01:36 CPU0000: RA=0000000000000000 RB=0000000000000000
23:01:36 CPU0000: RC=0000000000000000 RD=0000000000000000
23:01:36 CPU0000: RE=0000000000000000 RF=0000000000000000.
.
.
```

Figure 6: Message prefixing using the native Hercules console

6.4.2 Hercules using the WinGUI

Using the WinGUI with the Windows version of Hercules gives you the possibility to prefix all messages with the current date, the current time and the process ID. These prefixing options can be selected individually in the "Format" tab of the "Advanced Logging Options", where they can be separately turned on or off as showed in the next figure.

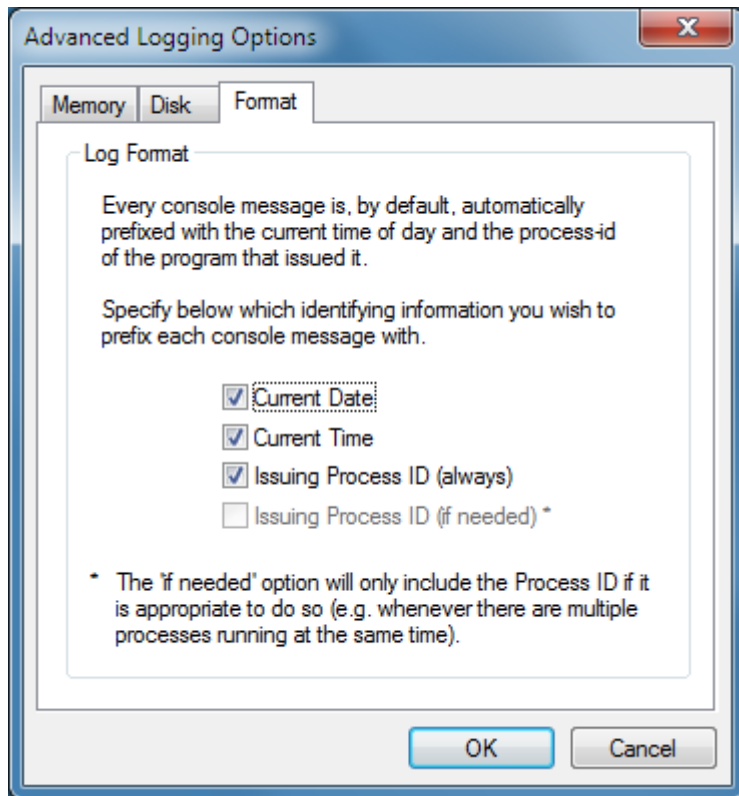

Figure 7: WinGUI Advanced Logging Options

The logopt system parameter or console command has no effect when using the WinGUI. Prefixing the messages is only influenced over the GUI settings. The following figure shows the log messages using all prefixing options (date, time and process ID) as specified above.

```

.
.
.
2010/06/18 19:12:18.071 000008E4 HHC01416I Build information:
2010/06/18 19:12:18.071 000008E4 HHC01417I Windows (MSVC) build for AMD64
2010/06/18 19:12:18.071 000008E4 HHC01417I Modes: S/370 ESA/390 z/Arch
2010/06/18 19:12:18.071 000008E4 HHC01417I Max CPU Engines: 8
2010/06/18 19:12:18.071 000008E4 HHC01417I Using fthreads Threading Model
2010/06/18 19:12:18.072 000008E4 HHC01417I Using FishIO
2010/06/18 19:12:18.072 000008E4 HHC01417I Dynamic loading support
2010/06/18 19:12:18.072 000008E4 HHC01417I Using shared libraries
2010/06/18 19:12:18.072 000008E4 HHC01417I HTTP Server support
2010/06/18 19:12:18.072 000008E4 HHC01417I No SIGABEND handler
2010/06/18 19:12:18.072 000008E4 HHC01417I Regular Expressions support
2010/06/18 19:12:18.072 000008E4 HHC01417I Automatic Operator support
.
.
.

```

Figure 8: Message prefixing using the console of the Hercules WinGUI

6.5 Hercules Console Commands (sorted alphabetically)

The following table shows an overview of the valid Hercules console commands that can be entered in the control panel (Hercules console display). In this table the commands are sorted alphabetically rather than grouped by functionality.

Command	Description
!message	SCP priority message
# or *	Log comment to syslog
.reply	SCP command
?	List all commands / command specific help (alias for help)
aea	Display AEA tables
aia	Display AIA tables
ar	Display access registers
archmode	Set architecture mode
attach	Configure device
auto_scsi_mount	Automatic SCSI tape mounts (synonym for SCSIMOUNT)
automount	Show or update allowable tape automount directories
b	Set breakpoint (synonym for B+)
b+	Set breakpoint (synonym for B)
b-	Delete breakpoint
cache	Cache command
cckd	CCKD command
cd	Change directory
cf	Configure CPU online or offline
cfall	Configure all CPU's online or offline
clocks	Display TOD clock and CPU timer
cmdtgt	Specify the command target
conkpalv	Display / alter console TCP/IP keep-alive settings
cpu	Define target CPU for console display and commands

Command	Description
cr	Display or alter control registers
cscript	Cancel a running script thread
ctc	Enable / disable CTC debugging
define	Rename device
defsym	Define symbol
detach	Remove device
devinit	Reinitialize device
devlist	List device or all devices
devtmax	Display or set max device threads
ds	Display subchannel
ecpsvm	ECPS:VM commands
exit	Synonym for "quit"
ext	Generate external interrupt
f{+/-} addr	Mark frames usable / unusable
fpc	Display floating point control registers
fpr	Display floating point register
g	Turn off instruction stepping and start CPU
gpr	Display or alter general purpose registers
hao	Hercules Automated Operator (HAO)
help	List all commands / command specific help
herc	Send Hercules command
herclogo	Read a new logo file
hst	History of commands
i	Generate I/O attention interrupt for device
iodelay	Display or set I/O delay value
ipending	Display pending interrupts

Command	Description
ipl	IPL normal from device xxxx
iplc	IPL clear from device xxxx
k	Display CCKD internal trace
ldmod	Load a module
loadcore	Load a core image file
loadparm	Set IPL parameter
loadtext	Load a text deck file
log	Direct log output
logopt	Change log options
lparname	Display or set LPAR name
lparnum	Display or set LPAR identification number
lsdep	List module dependencies
lsmmod	List dynamic modules
maxrates	Display maximum observed MIPS/SIO rate or define new reporting interval
message	Display message on console like VM
mounted_tape_reinit	Control tape initialization
msg	Display message on console like VM
msghld	Display or set timeout value of held messages
msgnoh	Display message on console like VM, but without header
ostailor	Specify intended operating system
panrate	Display or set console refresh rate
pgmtrace	Trace program interrupts
pr	Display prefix register
pscp	Send system control program priority message
psw	Display or alter program status word
ptt	Set / display pthread trace

Command	Description
pwd	Print working directory
qd	Query DASD
quiet	Toggle automatic refresh of console display data
quit	Terminate the emulator
r	Display or alter real storage
restart	Generate restart interrupt
resume	Resume Hercules
rmmod	Delete a module
s	Instruction stepping
s+	Instruction stepping on
s-	Instruction stepping off
s?	Instruction stepping query
s{+/-} dev	Turn CCW stepping on / off
savecore	Save a core image file
sclpboot	Set or display SCLP base directory
scp	Send system control program command
script	Run a sequence of console commands contained in a file
scsimount	Automatic SCSI tape mounts (synonym for AUTO_SCSI_MOUNT)
sf+	Create a new shadow file
sf-	Remove a shadow file
sfc	Compress a shadow file
sfd	Display shadow file statistics
sfk	Perform a chkdsk on the active shadow file
sh	Shell command
shrd	SHRD command
sizeof	Display size of structures

Command	Description
ssd	Signal Shutdown
start	Start CPU or printer device
startall	Start all CPU's
stop	Stop CPU or printer device
stopall	Stop all CPU's
store	Store CPU status at absolute zero
suspend	Suspend Hercules
syncio	Display syncio device statistics
sysclear	Issue SYSTEM CLEAR RESET manual operation
sysreset	Issue SYSTEM RESET manual operation
t	Instruction trace
t+	Instruction trace on
t-	Instruction trace off
t?	Instruction trace query
t{+/-} CKD	Turn CKD_KEY tracing on / off
t{+/-} dev	Turn CCW tracing on / off
timerint	Display or set timers update interval
tlb	Display TLB tables
toddrag	Display or set TOD clock drag factor
traceopt	Instruction trace display option
tt32	Control / query CTCI-W32 functionality
u	Disassemble storage
uptime	Display Hercules Emulator uptime
v	Display or alter virtual storage
version	Display version information

Table 10: Hercules Console Commands (sorted alphabetically)

6.6 Hercules Console Commands (grouped by functionality)

The next table shows an overview of the valid Hercules console commands that can be entered in the control panel (Hercules console display). In this table the commands are grouped by functionality.

Command	Description
help	List all commands / command specific help
?	List all commands / command specific help (alias for help)
# or *	Log comment to syslog
message	Display message on console like VM
msg	Display message on console like VM
msgnoh	Display message on console like VM, but without header
quiet	Toggle automatic refresh of console display data
hst	History of commands
hao	Hercules Automated Operator (HAO)
log	Direct log output
logopt	Change log options
uptime	Display Hercules Emulator uptime
version	Display version information
quit	Terminate the emulator
exit	Synonym for "quit"
cpu	Define target CPU for console display and commands
start	Start CPU or printer device
stop	Stop CPU or printer device
startall	Start all CPU's
stopall	Stop all CPU's
cf	Configure CPU online or offline

Command	Description
cfall	Configure all CPU's online or offline
.reply	SCP command
!message	SCP priority message
ssd	Signal Shutdown
ptt	Set / display pthread trace
i	Generate I/O attention interrupt for device
ext	Generate external interrupt
restart	Generate restart interrupt
archmode	Set architecture mode
loadparm	Set IPL parameter
lparname	Display or set LPAR name
lparnum	Display or set LPAR identification number
ipl	IPL normal from device xxxx
iplc	IPL clear from device xxxx
sysreset	Issue SYSTEM RESET manual operation
sysclear	Issue SYSTEM CLEAR RESET manual operation
store	Store CPU status at absolute zero
sclproof	Set or display SCLP base directory
psw	Display or alter program status word
gpr	Display or alter general purpose registers
fpr	Display floating point register
fpc	Display floating point control registers
cr	Display or alter control registers
ar	Display access registers
pr	Display prefix register

Command	Description
timerint	Display or set timers update interval
clocks	Display TOD clock and CPU timer
ipending	Display pending interrupts
ds	Display subchannel
r	Display or alter real storage
v	Display or alter virtual storage
u	Disassemble storage
devtmax	Display or set max device threads
k	Display CCKD internal trace
attach	Configure device
detach	Remove device
define	Rename device
devinit	Reinitialize device
devlist	List device or all devices
qd	Query DASD
mounted_tape_reinit	Control tape initialization
auto_scsi_mount	Automatic SCSI tape mounts (synonym for SCSIMOUNT)
scsimount	Automatic SCSI tape mounts (synonym for AUTO_SCSI_MOUNT)
automount	Show or update allowable tape automount directories
cd	Change directory
pwd	Print working directory
sh	Shell command
cache	Cache command
cckd	CCKD command
shrd	SHRD command

Command	Description
conkpalv	Display / alter console TCP/IP keep-alive settings
t	Instruction trace
t+	Instruction trace on
t-	Instruction trace off
t?	Instruction trace query
s	Instruction stepping
s+	Instruction stepping on
s-	Instruction stepping off
s?	Instruction stepping query
b	Set breakpoint (synonym for B+)
b+	Set breakpoint (synonym for B)
b-	Delete breakpoint
g	Turn off instruction stepping and start CPU
ostailor	Specify intended operating system
pgmtrace	Trace program interrupts
savecore	Save a core image file
loadcore	Load a core image file
loadtext	Load a text deck file
ldmod	Load a module
rmmod	Delete a module
lsmod	List dynamic modules
lsdep	List module dependencies
iodelay	Display or set I/O delay value
ctc	Enable / disable CTC debugging
tt32	Control / query CTCI-W32 functionality

Command	Description
toddrag	Display or set TOD clock drag factor
panrate	Display or set console refresh rate
msghld	Display or set timeout value of held messages
syncio	Display syncio device statistics
maxrates	Display maximum observed MIPS/SIO rate or define new reporting interval
defsym	Define symbol
script	Run a sequence of console commands contained in a file
cscript	Cancel a running script thread
ecpsvm	ECPS:VM commands
aea	Display AEA tables
aia	Display AIA tables
tlb	Display TLB tables
sizeof	Display size of structures
suspend	Suspend Hercules
resume	Resume Hercules
herclogo	Read a new logo file
traceopt	Instruction trace display option
cmdtgt	Specify the command target
herc	Send Hercules command
scp	Send system control program command
pscp	Send system control program priority message
sf+	Create a new shadow file
sf-	Remove a shadow file
sfc	Compress a shadow file

Command	Description
sfd	Display shadow file statistics
sfk	Perform a chkdsk on the active shadow file
t{+/-} dev	Turn CCW tracing on / off
s{+/-} dev	Turn CCW stepping on / off
t{+/-} CKD	Turn CKD_KEY tracing on / off
f{+/-} addr	Mark frames usable / unusable

Table 11: Hercules Console Commands (grouped by functionality)

7. Console Command Descriptions

7.1 !message (SCP priority message)

7.1.1 Function

The “!message” (SCP) command is used to enter a system control program (i.e. guest operating system) priority command on the hercules console. The command to be issued has to be prefixed with an exclamation point '!’.

This command is similar to the “.reply” command. It is up to the operating system to differentiate between them.

7.1.2 Syntax

Descriptive

!prio_msg

Diagram

▶— *!prio message* —▶

7.1.3 Parameter

prio_msg The priority message that will be routed to the system control program running under the Hercules Emulator.

7.1.4 Examples

For a similar sample please see the “.reply” command.

7.2 # or * (Log comment to syslog)

7.2.1 Function

The hash ("#") or asterisk ("*") simply provide a convenient way of entering comments into the Hercules console log with no other effect. The comment is not processed in any way other than to echo it at the console.

7.2.2 Syntax

Descriptive

anytext

or

* *anytext*

Diagram

▶— # — *anytext* —————▶◀

or

▶— * — *anytext* —————▶◀

7.2.3 Parameter

anytext The text that has to be displayed on the Hercules system log.

7.2.4 Examples

Example 1:

Log a text string to the syslog.

```
09:09:34.781 00000FC4 * Comment routed to Hercules system log.
```

Figure 9: Log comment command

7.3 .reply (SCP command)

7.3.1 Function

The “.reply” (SCP) command is used to give a reply to a system control program (i.e. the guest operating system running under Hercules) message. To reply to a SCP message that gets issued to the Hercules console, prefix the reply with a period (dot).

7.3.2 Syntax

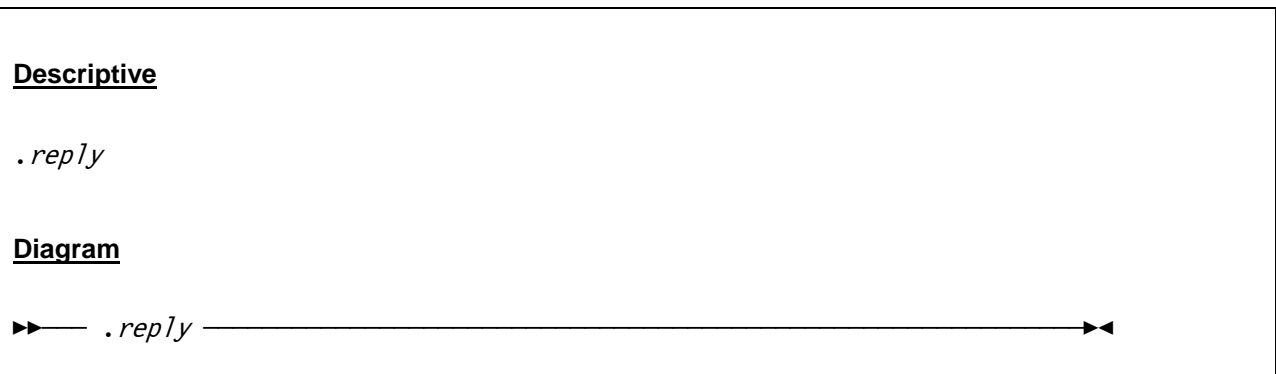

7.3.3 Parameter

reply The reply that will be routed to the system control program running under the Hercules Emulator.

7.3.4 Examples

Example 1:

Reply to message IGGN504A.

```
2007/06/30 09:09:34.781 00000FC4 *   IGGN504A SPECIFY UNIT FOR CATALOG.MVS.MASTER ON MVSRES
2007/06/30 09:10:04.390 00000FC4 .r 00,0148
2007/06/30 09:10:04.406 00000FC4 HHCCP041I SYSCONS interface active
2007/06/30 09:10:04.406 00000FC4 IEE600I REPLY TO 00 IS:0148
```

Figure 10: SCP command

7.4 ? (List all commands / command specific help)

7.4.1 Function

The "?" command is an alias for the HELP command and displays additional information for specific Hercules console commands if extra information is available. If the command has additional help text it will be displayed. "?" without parameter lists all available commands. The help text is usually limited to explaining the format of the command and its various required or optional parameters and is not meant to replace reading the documentation.

7.4.2 Syntax

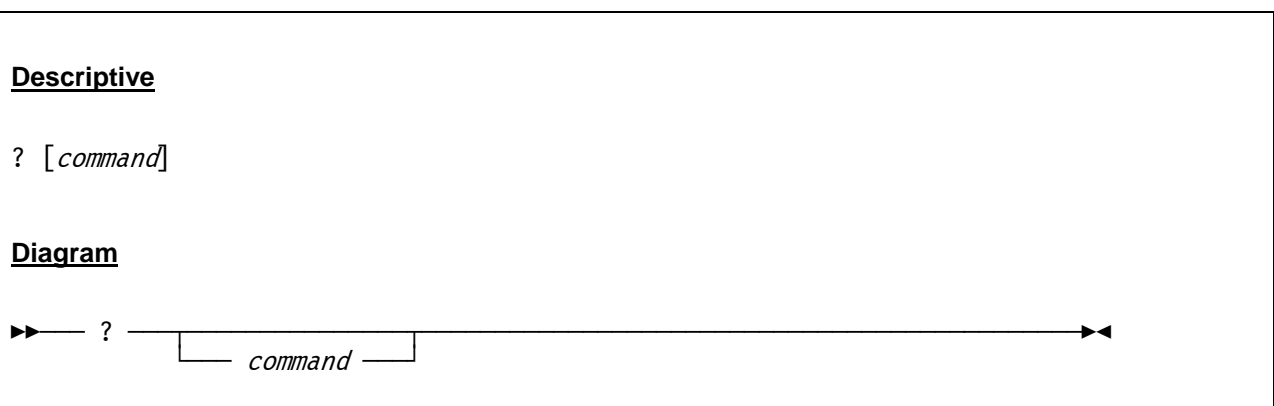

7.4.3 Parameter

command The Hercules console command to which additional information is desired.

7.4.4 Examples

Example 1:

List all valid console commands.

```
22:51:42.150 00000F28 ?
22:51:42.150 00000F28 HHCPN140I Valid panel commands are...
22:51:42.150 00000F28
22:51:42.150 00000F28 Command      Description...
22:51:42.150 00000F28 -----      -----
22:51:42.165 00000F28 ?           list all commands
22:51:42.165 00000F28 help        command specific help
22:51:42.165 00000F28 *           (log comment to syslog)
22:51:42.165 00000F28
22:51:42.165 00000F28 hst         history of commands
22:51:42.165 00000F28 log         direct log output
22:51:42.165 00000F28 logopt      change log options
```

22:51:42.165	00000F28	version	display version information
22:51:42.165	00000F28		
22:51:42.165	00000F28	quit	terminate the emulator
22:51:42.165	00000F28	exit	(synonym for 'quit')
22:51:42.165	00000F28		
22:51:42.165	00000F28	cpu	define target cpu for panel display and commands
22:51:42.165	00000F28		
22:51:42.165	00000F28	start	start CPU (or printer device if argument given)
22:51:42.165	00000F28	stop	stop CPU (or printer device if argument given)
22:51:42.165	00000F28		
22:51:42.165	00000F28	startall	start all CPU's
22:51:42.165	00000F28	stopall	stop all CPU's
22:51:42.181	00000F28		
22:51:42.181	00000F28	herclogo	Read a new hercules logo file
22:51:42.181	00000F28		
22:51:42.181	00000F28	traceopt	Instruction trace display options
22:51:42.181	00000F28		
22:51:42.181	00000F28	sf+dev	add shadow file
22:51:42.181	00000F28	sf-dev	delete shadow file
22:51:42.181	00000F28	sf=dev ..	rename shadow file
22:51:42.181	00000F28	sfc	compress shadow files
22:51:42.181	00000F28	sfd	display shadow file stats
		.	
		.	
		.	
22:51:42.181	00000F28		
22:51:42.181	00000F28	t{+/-}dev	turn CCW tracing on/off
22:51:42.181	00000F28	s{+/-}dev	turn CCW stepping on/off
22:51:42.181	00000F28	t{+/-}CKD	turn CKD_KEY tracing on/off
22:51:42.181	00000F28	f{+/-}adr	mark frames unusable/usable

Figure 11: “?” command

7.5 AEA (Display AEA tables)

7.5.1 Function

Display the Hercules AEA tables. The AEA table is an address lookup accelerator which saves absolute data addresses for further lookups to eliminate the calls to `logical_to_main`. This shortens the translation path length.

7.5.2 Syntax

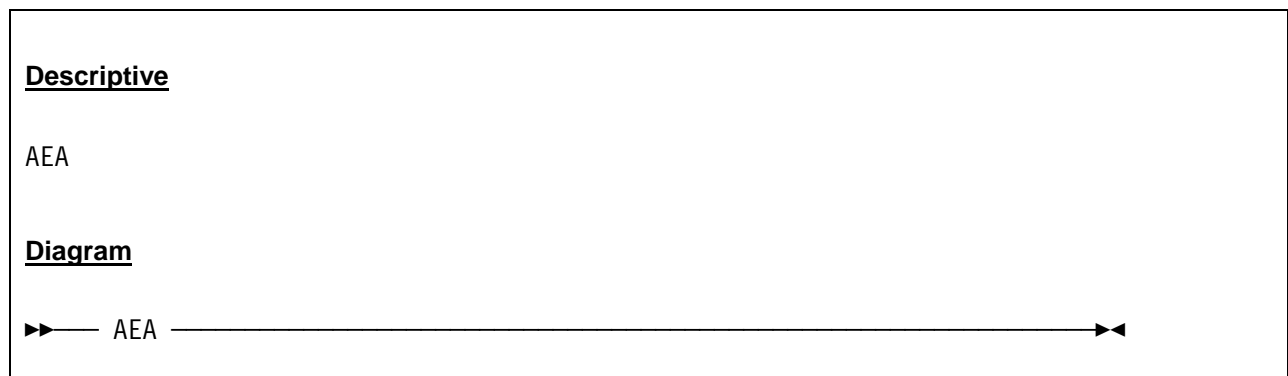

7.5.3 Parameter

None.

7.5.4 Examples

Example 1:

Display the AEA tables

```
14:21:38.731 00000FC4 aea
14:21:38.731 00000FC4 aea mode Primary
14:21:38.731 00000FC4 aea ar 0d 07 01 -1 01 01 01 01 01 01 01 01 01 01 01 01 01 01 01 01 01
14:21:38.731 00000FC4 aea common 0 0 01 0 0 0 0 0 0 0 01 0 0 0 0 0 0 0 0 0 0
14:21:38.731 00000FC4 aea cr[1] 000000003ffffe07f
14:21:38.731 00000FC4 cr[7] 000000003ffffe07f
14:21:38.731 00000FC4 cr[13] 000000003ffffe07f
14:21:38.731 00000FC4 cr[r] 00000000fffffffff
```

Figure 12: AEA command

7.6 AIA (List AIA fields)

7.6.1 Function

Display the Hercules AIA fields. The AIA fields are an instruction fetch accelerator which save absolute instruction addresses for further lookups to shorten the translation path length.

7.6.2 Syntax

Descriptive

AIA

Diagram

▶— AIA —————▶

7.6.3 Parameter

None.

7.6.4 Examples

Example 1:

Display the AIA fields.

```
00000FC4 aia
00000FC4 mainstor 10041000 aim 4ECA4000 aiv 0000000001581000 aie 0000000000000000
```

Figure 13: AIA command

7.7 AR (Display access registers)

7.7.1 Function

Display the current contents of the access registers.

7.7.2 Syntax

Descriptive

AR

Diagram

▶— AR —————▶

7.7.3 Parameter

None.

7.7.4 Examples

Example 1:

Display the access registers.

```
14:22:01.091 00000FC4 ar
14:22:01.091 00000FC4 CPU0000: AR00=00000000 AR01=00000000 AR02=0000195B AR03=88586380
14:22:01.091 00000FC4 CPU0000: AR04=88582860 AR05=090C52C8 AR06=88586190 AR07=00000000
14:22:01.091 00000FC4 CPU0000: AR08=8858631C AR09=081F6060 AR10=00000000 AR11=00000000
14:22:01.091 00000FC4 CPU0000: AR12=00000000 AR13=00000000 AR14=00000002 AR15=00000000
```

Figure 14: AR command

7.8 ARCHMODE (Set architecture mode)

7.8.1 Function

Specifying the archmode command without any parameters displays the current setting of the the initial architecture mode. Additional parameters may be specified to set a new value for the architecture mode.

7.8.2 Syntax

Descriptive

ARCHMODE [S/370 | ESA/390 | ESAME | z/ARCH]

Diagram

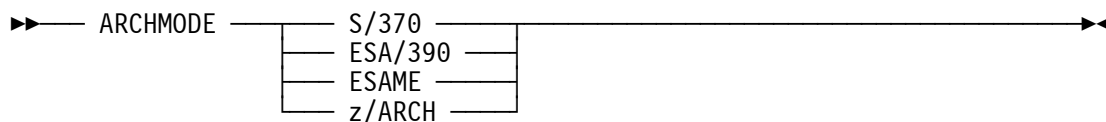

7.8.3 Parameter

S/370 Use S/370 for OS/360, VM/370 and MVS 3.8

ESA/390 Use ESA/390 for MVS/XA, MVS/ESA, OS/390, VM/ESA, VSE/ESA, Linux/390 and ZZSA. z/OS can be run until version 1.2 with ESA/390 mode without installed bimodal feature or until version 1.4 with installed bimodal feature.

ESAME Use ESAME (Enterprise System Architecture, Modal Extensions) for z/OS, z/VM, z/VSE and z/Linux. When ESAME is specified, the machine will always be IPL'ed in ESA/390 mode but the system is capable of being switched into the z/Architecture mode after IPL. This is handled automatically by all z/Architecture operating systems.

z/ARCH This is the same as ESAME.

7.8.4 Examples

Example 1:

Display the current setting of the initial architecture mode.

```
2007/06/30 08:15:41.859 00000FC4 archmode
2007/06/30 08:15:41.859 00000FC4 HHCPN126I Architecture mode = ESA/390
```

Figure 15: ARCHMODE command (display architecture mode)

Example 2:

Change the setting of the current architecture mode.

```
2007/06/30 08:15:54.625 00000FC4 archmode esame  
2007/06/30 08:15:54.625 00000FC4 HHCPN129I Architecture successfully set to z/Arch mode.
```

Figure 16: ARCHMODE command (set architecture mode)

7.9 ATTACH (Configure device)

7.9.1 Function

The ATTACH command configures a new device and makes it available in the active configuration. The effect of this command is immediately visible in the device display of the Hercules Windows GUI or the Hercules “Peripherals” display if the GUI is not used.

7.9.2 Syntax

Descriptive

ATTACH *devn type [argument [argument ...]]*

Diagram

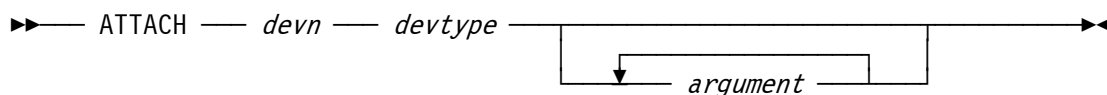

7.9.3 Parameter

- devn** The device number of the device that is to be configured in the current configuration.
- type** The device type that is to be configured in the current configuration. For a list of valid device types see chapter 5 (Device Definition Descriptions).
- arguments** These are the additional arguments for the device that is to be configured in the current configuration. The arguments are dependent on the device type. For additional information on the valid arguments see chapter 5 (Device Definition Descriptions).

7.9.4 Examples

Example 1:

Attach a printer device to the active configuration.

```
2007/06/30 13:32:45.562 00000618 attach 000f 1403 d:/mvs/prt/prt2.txt crlf
```

Figure 17: ATTACH command (configure printer)

Example 2:

Attach a display terminal to the active configuration.

```
2007/06/30 13:33:01.062 00000618 attach 0700 3270
```

Figure 18: ATTACH command (configure display terminal)

7.10 AUTOMOUNT (Show or update allowable tape automount directories)

7.10.1 Function

The AUTOMOUNT command allows it to add or delete entries from the list of allowable/unallowable tape automount directories, or lists all currently defined list entries, if any.

The format of the <dir> directory operand for add/del operations is identical to that as described in the documentation for the AUTOMOUNT configuration file statement (i.e. prefix with '+' or '-' as needed).

The automount feature is appropriately enabled or disabled for all tape devices as needed depending on the updated empty/non-empty list state.

7.10.2 Syntax

Descriptive

AUTOMOUNT {ADD *directory* | DEL *directory* | LIST}

or

AUTOMOUNT [± | -] *directory*

Diagram

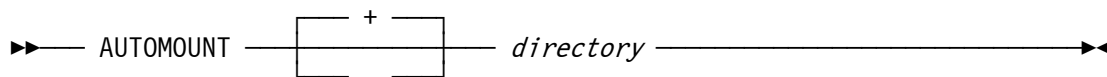

or

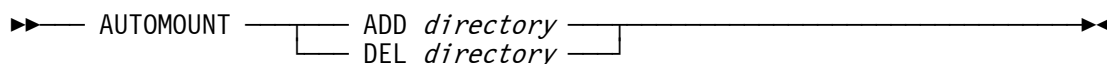

7.10.3 Parameter

- ADD or +** Add an entry to the list of allowable tape automount directories.
- DEL or -** Delete an entry from the list of allowable tape automount directories.
- LIST** List all currently defined list entries of allowable tape automount directories.
- directory** Specifies the host system directory where the guest is allowed or not to automatically load virtual tape volumes from.

7.10.4 Examples

Example 1:

Add an entry to the list of allowable tape automount directories.

```
0000097C automount add D:/MVS/Tape_1
0000097C HHCPN210I Default Allowed AUTOMOUNT directory = "D:\MVS\Tape_1\"
0000097C automount add D:/MVS/Tape_2
0000097C HHCPN210I Allowed AUTOMOUNT directory = "D:\MVS\Tape_2\"
```

Figure 19: AUTOMOUNT command (add entry)

Example 2:

List all currently defined list entries of allowable tape automount directories.

```
0000097C automount list
0000097C HHCPN203I "+D:\MVS\Tape_1\"
0000097C HHCPN203I "+D:\MVS\Tape_2\"
```

Figure 20: AUTOMOUNT command (list entries)

Example 3:

Delete an entry from the list of allowable tape automount directories.

```
0000097C automount del D:/MVS/Tape_2
0000097C HHCPN214I Ok.
```

Figure 21: AUTOMOUNT command (delete entry)

7.11 AUTO_SCSI_MOUNT (Automatic SCSI tape mounts)

7.11.1 Function

The AUTO_SCSI_MOUNT command displays or modifies the automatic SCSI tape mount option. When entered without any operands it displays the current value and any pending tape mount requests. Entering a value between 1 and 99 enables the option and specifies how often (in seconds) to query SCSI tape drives to automatically detect when a tape has been mounted. When a tape is mounted an unsolicited device attention interrupt will be presented to the guest operating system.

Notes: Enabling this option may negatively impact Hercules performance depending on how the host operating system (Windows, Linux, etc.) processes SCSI attached tape drive status queries. AUTO_SCSI_MOUNT is a synonym for the SCSIMOUNT command.

7.11.2 Syntax

Descriptive

AUTO_SCSI_MOUNT [NO | YES | *n*]

Diagram

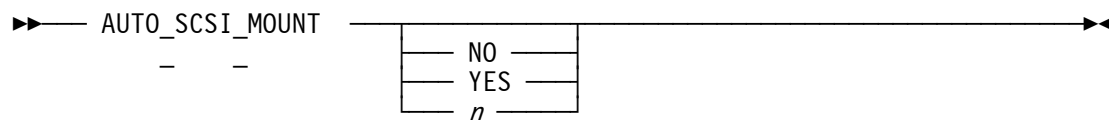

7.11.3 Parameter

- NO** No indicates that the AUTO_SCSI_MOUNT option is disabled forcing all SCSI tape mounts to be done manually via an appropriate DEVINIT command.
- YES** Yes enables the option and causes periodic queries of the SCSI tape drive in a five second interval to automatically detect when a tape is mounted. YES is equivalent with "AUTO_SCSI_MOUNT 5".
- n** A value from 1 to 99 seconds inclusive enables the option and causes periodic queries of the SCSI tape drive to automatically detect when a tape is mounted.

7.11.4 Examples

Example 1:

Display the current AUTO_SCSI_MOUNT settings.

```
2009/03/07 21:50:43.843 00000574 auto_scsi_mount
2009/03/07 21:50:43.843 00000574 Auto SCSI mount 0 seconds
```

Figure 22: AUTO_SCSI_MOUNT command (display settings)

Example 2:

Set AUTO_SCSI_MOUNT to 30 seconds.

```
2009/03/07 21:50:52.062 00000574 auto_scsi_mount 30
2009/03/07 21:51:04.468 00000574 auto_scsi_mount
2009/03/07 21:51:04.468 00000574 Auto SCSI mount 30 seconds
```

Figure 23: AUTO_SCSI_MOUNT command (set value)

7.12 B (Set breakpoint)

7.12.1 Function

The B command sets a breakpoint. The argument gives an instruction address or a range of addresses where you wish to halt the execution. Once the breakpoint is reached, instruction execution is temporarily halted and the next instruction to be executed is displayed. You may then examine registers and / or storage etc. To continue execution after reaching a breakpoint enter the “G” command.

The “B” and “B+” commands are synonymous with the “S+” command.

7.12.2 Syntax

Descriptive

B { *addr* | *addr-addr* }

Diagram

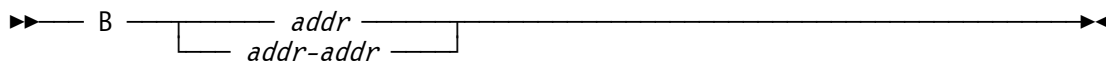

7.12.3 Parameter

addr Instruction address or range of addresses where instruction execution is to be stopped.

7.12.4 Examples

Example 1:

Set a breakpoint at instruction address 01000000.

```
12:50:14.546 00000FC4 b 01000000
12:50:14.546 00000FC4 HHCPN040I Setting breakpoint at 0000000001000000-0000000001000000
```

Figure 24: B command

7.13 B+ (Set breakpoint)

7.13.1 Function

The B+ command sets a breakpoint. The argument gives an instruction address or a range of addresses where you wish to halt the execution. Once the breakpoint is reached, instruction execution is temporarily halted and the next instruction to be executed is displayed. You may then examine registers and / or storage etc. To continue execution after reaching a breakpoint enter the “G” command.

The “B” and “B+” commands are synonymous with the “S+” command.

7.13.2 Syntax

Descriptive

B+ { *addr* | *addr-addr* }

Diagram

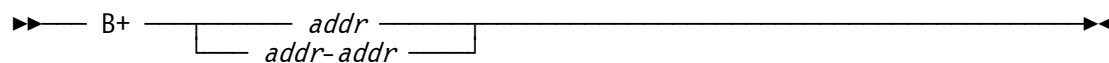

7.13.3 Parameter

addr Instruction address or range of addresses where instruction execution is to be stopped.

7.13.4 Examples

Example 1:

Set a breakpoint at instruction address 01000000.

```
12:50:14.546 00000FC4 b+ 01000000
12:50:14.546 00000FC4 HHCPN040I Setting breakpoint at 0000000001000000-0000000001000000
```

Figure 25: B+ command

7.14 B- (Delete breakpoint)

7.14.1 Function

The B- command removes any previously set breakpoint.

7.14.2 Syntax

Descriptive

B-

Diagram

► B- —————><

7.14.3 Parameter

None.

7.14.4 Examples

Example 1:

Delete the previously set breakpoint.

```
2007/06/30 12:50:33.312 00000FC4 b-
2007/06/30 12:50:33.312 00000FC4 HHCPN041I Deleting breakpoint
```

Figure 26: B- command

7.15 CACHE (Cache command)

7.15.1 Function

The CACHE command displays the current Hercules cache statistics.

7.15.2 Syntax

Descriptive

CACHE

Diagram

▶— CACHE —————▶

7.15.3 Parameter

None.

7.15.4 Examples

Example 1:

Display the current cache statistics.

```
2007/06/30 14:28:48.622 00000FC4 cache
2007/06/30 14:28:48.622 00000FC4 cache..... 0
2007/06/30 14:28:48.622 00000FC4 nbr ..... 229
2007/06/30 14:28:48.622 00000FC4 busy ..... 0
2007/06/30 14:28:48.622 00000FC4 busy% ..... 0
2007/06/30 14:28:48.622 00000FC4 empty ..... 0
2007/06/30 14:28:48.622 00000FC4 waiters ..... 0
2007/06/30 14:28:48.622 00000FC4 waits ..... 0
2007/06/30 14:28:48.622 00000FC4 buf size ..... 13014528
2007/06/30 14:28:48.622 00000FC4 hits ..... 80529
2007/06/30 14:28:48.622 00000FC4 fast hits ..... 73072
2007/06/30 14:28:48.622 00000FC4 misses ..... 22839
2007/06/30 14:28:48.622 00000FC4 hit% ..... 77
2007/06/30 14:28:48.622 00000FC4 age ..... 94500
2007/06/30 14:28:48.622 00000FC4 last adjusted ... Thu Jan 01 01:00:00 1970
2007/06/30 14:28:48.622 00000FC4 last wait ..... Thu Jan 01 01:00:00 1970
2007/06/30 14:28:48.622 00000FC4 adjustments ..... 0
2007/06/30 14:28:48.622 00000FC4 cache[1] ..... not created
```

```
2007/06/30 14:28:48.622 00000FC4 cache[2] ..... not created
2007/06/30 14:28:48.622 00000FC4 cache[3] ..... not created
2007/06/30 14:28:48.622 00000FC4 cache[4] ..... not created
2007/06/30 14:28:48.622 00000FC4 cache[5] ..... not created
2007/06/30 14:28:48.622 00000FC4 cache[6] ..... not created
2007/06/30 14:28:48.622 00000FC4 cache[7] ..... not created
```

Figure 27: CACHE command

7.16 CCKD (CCKD command)

7.16.1 Function

The CCKD console command can be used to affect CCKD processing. The CCKD console command supports the same options as the CCKD configuration statement.

7.16.2 Syntax

Descriptive

CCKD [HELP | STATS | OPTS | *option=value* [,*option=value* ...]]

where option can be:

[COMP={-1 | *n*}]

[,COMPPARM={-1 | *n*}]

[,RA={2 | *n*}]

[,RAQ={4 | *n*}]

[,RAT={2 | *n*}]

[,WR={2 | *n*}]

[,GCINT={5 | *n*}]

[,GCPARM={0 | *n*}]

[,NOSTRESS={0 | 1}]

[,FREEPEND={-1 | *n*}]

[,FSYNC={0 | 1}]

[,TRACE={0 | *n*}]

[,LINUXNULL={0 | 1}]

[,GCSTART={0 | 1}]

Diagram

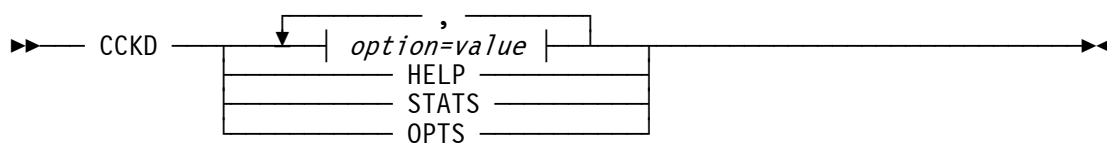

where option can be:

COMP=

COMPPARM=

RA=

RAQ=

RAT=

WR=

GCINT=

GCPARM=

NOSTRESS=

FREPEND=

FSYNC=

TRACE=

LINUXNULL=

GCSTART=

7.16.3 Parameter

HELP Display the CCKD help information (CCKD command only).
STATS Display the current CCKD statistics (CCKD command only).
OPTS Display the current CCKD options (CCKD command only).

option Set a CCKD option. Multiple options may be specified, seperated by a comma with no intervening blanks.

The CCKD options are:

COMP=n Specifies the compression type to be used. This overrides the compression used for all CCKD files. The default (-1) means don't override the compression. Valid compression types are:

- 1 Default
- 0 None
- 1 zlib
- 2 bzip2

COMPPARM=n Overrides the compression parameter. A higher value generally means more compression at the expense of CPU and/or storage. The default (-1) means don't override the compression parameter. The value of *n* can be from -1 and 9.

RA=n Sets the Number of readahead threads. When sequential track or block group access is detected, some number (RAT=n) of tracks or block groups are queued (RAQ=n) to be read by one of the readahead threads. The default is 2, the value of *n* can be a number from 1 to 9.

RAQ=n Sets the size of the readahead queue. When sequential track or block group access is detected, some number (RAT=n) of tracks or block groups are queued in the readahead queue. The default is 4, the value of *n* can be a number from 0 to 16. A value of zero disables readahead.

RAT=n Sets the number of tracks or block groups to readahead when sequential track or block group access is detected. The default is 2, the value of *ratn* can be a number from 0 to 16. A value of zero disables readahead.

WR=n Sets the number of writer threads. When the cache is flushed, updated cache entries are marked write pending and a writer thread is signalled. The writer thread compresses the track or block group and writes the compressed image to the emulation file. A writer thread is cpu-intensive while compressing the track or block group and I/O-intensive while writing the compressed image. The writer thread runs one nicer than the CPU thread(s). The default is 2, a value from 1 to 9 can be specified

GCINT=n This is the number of seconds the garbage collector thread waits during an interval. At the end of an interval the garbage collector performs space recovery, flushes the cache and optionally fsyncs the emulation file. However, the file will not be fsynced unless at least 5 seconds have elapsed since the last fsync. The default is 10 seconds. You can specify a number between 1 to 60.

GCPARM=n A value affecting the amount of data moved during the garbage collector's space recovery routine. The garbage collector determines an amount of space to move based on the ratio of free space to used space in an emulation file and on the number of free spaces in the file. The garbage collector wants to reduce the free space to used space ratio and the number of free spaces. The value is logarithmic; a value of 8 means

moving 2^8 the selected value while a negative value similarly decreases the amount to be moved. Normally, 256K will be moved for a file in an interval. Specifying a value of 8 can increase the amount to 64M. At least 64K will be moved. Specifying a large value (such as 8) may not increase the garbage collection efficiency correspondingly. The default is 0. You can specify a number from -8 to 8.

- NOSTRESS=n** Indicates whether stress writes will occur or not. A track or block group may be written under stress when a high percentage of the cache is pending write or when a device I/O thread is waiting for a cache entry. When a stressed write occurs, the compression algorithm and/or compression parm may be relaxed, resulting in faster compression but usually a larger compressed image. If NOSTRESS is set to one, then a stressed situation is ignored. You would typically set this value to one when you want create the smallest emulation file possible in exchange for a possible performance degradation. The default is 0. You can specify 0 (enable stressed writes) or 1 (disable stressed writes).
- FREPEND=n** Specifies the free pending value for freed space. When a track or block group image is written, the space it previously occupied is freed. This space will not be available for future allocations until *n* garbage collection intervals have completed. In the event of a catastrophic failure, previously written track or block group images should be recoverable if the current image has not yet been written to the physical disk. By default the value is set to -1 which means that if fsync is specified then the value is 1 otherwise it is 2. If 0 is specified then freed space is immediately available for new allocations. The default is -1. You can specify a number from -1 to 4.
- FSYNC=n** Enables or disables fsync. When fsync is enabled then the disk emulation file is synchronized with the physical hard disk at the end of a garbage collection interval (no more often than 5 seconds though). This means that if freepend is non-zero and a catastrophic error occurs, the emulated disks should be recovered coherently. However, fsync may cause performance degradation depending on the host operating system and / or the host operating system level. The default is 0 (fsync disabled), you can specify 0 (disable fsync) or 1 (enable fsync).
- TRACE=n** Specifies the number of cckd trace entries. You would normally specify a non-zero value when debugging or capturing a problem in cckd code. When the problem occurs, you should enter the "k" Hercules console command which will print the trace table entries. The default is 0. You can specify a number between 0 and 200'000. Each trace entry represents 128 bytes. Normally, for debugging, it is recommended to use 100'000.
- LINUXNULL=n** If set to 1 then tracks written to 3390 CCKD volumes that were initialized with the *-linux* option will be checked if they are null (that is if all 12 4096 byte user records contain zeroes). This is used by the DASDCOPY utility. The default is 0.
- GCSTART=n** If set to 1 then space recovery will become active on any emulated disks that have free space. Normally space recovery will ignore emulated disks until they have been updated. The default is 0.

Notes:

- The size of the *cache* is a difficult number to determine. The storage used by the cache could also be used for emulated virtual storage instead. You don't want to steal storage from your emulated operating system so that it starts paging heavily. You also don't want your host operating system to page. However, you don't want your cache to flush too often because cpu cycles may have to be stolen from the cpu thread to compress updated images.
- You need at least one *l2cache* entry per compressed device. Since the maximum number of *l2cache* entries is 1024, this implies that no more than 1024 compressed devices can be defined. If you have a large number of devices then specify the maximum value otherwise the default should suffice.

- *raq* should be at least as large as *ra*. Readahead threads are scheduled from entries in the readahead queue. Likewise *rat* should not exceed *raq* because only *raq* tracks or block groups can be queued at any time.
- The number of writer threads *wr* should usually be 1 more than the number of host processors. This is because one writer thread could be cpu-bound (compressing a track or block-group image) and the other could be i/o-bound (writing the compressed image).
- The garbage collection interval governs the maximum time in seconds an updated track or block group image will reside in storage before being written to the emulation file. A large value may mean more data loss if a catastrophic error occurs. A small value may mean that more cpu time is spent compressing images.

For example, suppose that a particular image is updated several times each second. If the interval is changed from the default 5 seconds to 1 second, then that image will be compressed and written 5 times more often. A large value may cause more cache flushes within a garbage collection interval. These kind of flushes mean that a read will wait because there are no available cache entries, slowing the emulated operating system.

A large value will also cause more pending free space to build up (since free space is flushed each interval). This may mean that the garbage collector space recovery routine will perform more work and that the emulation file may be larger.

- Specify *fsync=1* and *gcint=5* if you are absolutely paranoid about your data being lost due to a failure. *fsync* will ensure your data on disk is coherent. However, *fsync* may cause a noticeable performance degradation. Note that an *fsync* will not be performed more often than every 5 seconds.

A general advice is to use the default options and adjust them only if you have a very good reason to do so.

7.16.4 Examples

Example 1:

Display the CCKD help panel. There is no specific CCKD help command. The CCKD command without argument will present the list of available options.

```

17:51:36.796 0000008E cckd
17:51:36.796 0000008E cckd command parameters:
17:51:36.796 0000008E help          Display help message
17:51:36.796 0000008E stats        Display cckd statistics
17:51:36.796 0000008E opts          Display cckd options
17:51:36.796 0000008E comp=<n>      Override compression          (-1 .. 2)
17:51:36.796 0000008E compparm=<n>  Override compression parm    (-1 .. 9)
17:51:36.796 0000008E ra=<n>        Set number readahead threads  (1 .. 9)
17:51:36.796 0000008E raq=<n>       Set readahead queue size     (0 .. 16)
17:51:36.796 0000008E rat=<n>       Set number tracks to read ahead (0 .. 16)
17:51:36.796 0000008E wr=<n>        Set number writer threads     (1 .. 9)
17:51:36.796 0000008E gcint=<n>    Set garbage collector interval (sec) (1 .. 60)
17:51:36.796 0000008E gcparm=<n>   Set garbage collector parameter (-8 .. 8)
17:51:36.796 0000008E                (least aggressive ... most aggressive)

```

```

17:51:36.796 0000008E nostress=<n>      1=Disable stress writes
17:51:36.796 0000008E freepend=<n>      Set free pending cycles      (-1 .. 4)
17:51:36.796 0000008E fsync=<n>        1=Enable fsync()
17:51:36.796 0000008E trace=<n>        Set trace table size        (0 .. 200000)

```

Figure 28: CCKD HELP command

Example 2:

Display the CCKD options panel.

```

17:51:13.453 0000008E cckd opts
17:51:13.453 0000008E comp=-1,compparm=-1,ra=2,raq=4,rat=2,wr=2,gcint=10,gcparm=0,nostress=0,
17:51:13.453 0000008E      freepend=-1,fsync=0,trace=0,linuxnull=0

```

Figure 29: CCKD OPTS command

Example 3:

Display the CCKD statistics panel.

```

0000008E cckd stats
0000008E reads....      344 Kbytes...      5175 writes...      0 Kbytes...      0
0000008E readaheads      42 misses...      4 syncios..      337 misses...      302
0000008E switches.      650 12 reads.      6      stress writes...      0
0000008E cachehits      347 misses...      303 12 hits..      33 misses...      6
0000008E waits          i/o.....      2 cache....      0
0000008E garbage collector  moves....      0 Kbytes...      0

```

Figure 30: CCKD STATS command

Example 4:

Set a CCKD parameter.

```

18:23:38.187 00000B28 cckd gcint=30
18:23:38.187 00000B28 comp=-1,compparm=-1,ra=2,raq=4,rat=2,wr=2,gcint=30,gcparm=0,nostress=0,
18:23:38.187 00000B28      freepend=-1,fsync=0,trace=0,linuxnull=0

```

Figure 31: CCKD command (set options)

7.17 CD (Change directory)

7.17.1 Function

The CD command changes the current directory.

7.17.2 Syntax

Descriptive

CD *path*

Diagram

▶— CD — *path* —————▶

7.17.3 Parameter

path This specifies the new path. The path can be specified absolute (“D:\S390\DASD”) or relative to the current path (“DASD”).

7.17.4 Examples

Example 1:

Change the current directory (absolute path).

```
14:22:01.091 00000FC4 cd D:\S390
14:22:01.091 00000FC4 D:\S390
```

Figure 32: CD command (absolute path)

Example 2:

Change the current directory (relative path).

```
14:22:55.084 00000FC4 cd DASD
14:22:55.084 00000FC4 D:\S390\DASD
```

Figure 33: CD command (relative path)

7.18 CF (Configure CPU online or offline)

7.18.1 Function

The CF command is used to place a CPU online or offline. The number of the CPU to be taken online or offline has to be specified first with the CPU command (refer to the CPU command for further information). If the CF command is issued without a parameter, the actual status of the CPU is displayed.

Use the CFALL command to display the status of all CPUs or to configure all CPUs online or offline.

7.18.2 Syntax

Descriptive

CF [ON | OFF]

Diagram

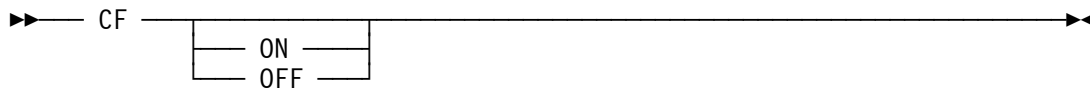

7.18.3 Parameter

ON Place the specified CPU online.

OFF Place the specified CPU offline.

7.18.4 Examples

Example 1:

Display the actual status of CPU 1.

```
2007/06/30 14:12:38.531 00000FC4 cpu 1
2007/06/30 14:12:42.796 00000FC4 cf
2007/06/30 14:12:42.796 00000FC4 HHCPN152I CPU0001 online
```

Figure 34: CF command (display CPU status)

Example 2:

Configure CPU 1 offline.

```
2007/06/30 14:12:47.531 00000FC4 cpu 1
2007/06/30 14:12:49.859 00000FC4 cf off
2007/06/30 14:12:49.859 00000FC4 HHCCP008I CPU0001 thread ended: tid=00000D28, pid=2972
2007/06/30 14:12:49.859 00000FC4 HHCPN153I CPU0001 offline
```

Figure 35: CF command (configure CPU offline)

Example 3:

Configure CPU 1 online.

```
14:12:50.531 00000FC4 cpu 1
14:12:52.906 00000FC4 cf on
14:12:52.906 00000FC4 HHCCP002I CPU0001 thread started: tid=000009D8, pid=2972, priority=0
14:12:52.906 00000FC4 HHCCP003I CPU0001 architecture mode ESA/390
14:12:52.906 00000FC4 HHCPN152I CPU0001 online
```

Figure 36: CF command (configure CPU online)

7.19 CFALL (Configure all CPUs online or offline)

7.19.1 Function

The CFALL command is used to place all CPUs online or offline. If the CFALL command is issued without a parameter, the actual status of all CPUs is displayed

7.19.2 Syntax



7.19.3 Parameter

ON Place all CPUs online.
OFF Place all CPUs offline.

7.19.4 Examples

Example 1:

Display the current status of all CPUs.

```
2007/06/30 14:24:25.875 00000FC4 cfall
2007/06/30 14:24:25.875 00000FC4 HHCPN154I CPU0000 online
2007/06/30 14:24:25.875 00000FC4 HHCPN154I CPU0001 online
2007/06/30 14:24:25.875 00000FC4 HHCPN155I CPU0002 offline
2007/06/30 14:24:25.875 00000FC4 HHCPN155I CPU0003 offline
2007/06/30 14:24:25.875 00000FC4 HHCPN155I CPU0004 offline
2007/06/30 14:24:25.875 00000FC4 HHCPN155I CPU0005 offline
```

Figure 37: CFALL command (display status of all CPUs)

Example 2:

Configure all CPUs offline.

```
2007/06/30 14:24:46.625 0000FC4 cfall off
2007/06/30 14:24:46.625 0000FC4 HHCCP008I CPU0000 thread ended: tid=0000CC0, pid=3172
2007/06/30 14:24:46.625 0000FC4 HHCCP008I CPU0001 thread ended: tid=0000012C, pid=3172
2007/06/30 14:24:46.625 0000FC4 HHCCP008I CPU0002 thread ended: tid=00000390, pid=3172
2007/06/30 14:24:46.625 0000FC4 HHCCP008I CPU0003 thread ended: tid=00000E08, pid=3172
2007/06/30 14:24:46.625 0000FC4 HHCCP008I CPU0004 thread ended: tid=00000EF4, pid=3172
2007/06/30 14:24:46.625 0000FC4 HHCCP008I CPU0005 thread ended: tid=00000FAC, pid=3172
2007/06/30 14:24:46.625 0000FC4 HHCPN155I CPU0000 offline
2007/06/30 14:24:46.625 0000FC4 HHCPN155I CPU0001 offline
2007/06/30 14:24:46.625 0000FC4 HHCPN155I CPU0002 offline
2007/06/30 14:24:46.625 0000FC4 HHCPN155I CPU0003 offline
2007/06/30 14:24:46.625 0000FC4 HHCPN155I CPU0004 offline
2007/06/30 14:24:46.625 0000FC4 HHCPN155I CPU0005 offline
2007/06/30 14:24:46.640 0000FC4 HHCTT003I Timer thread ended
```

Figure 38: CFALL command (configure all CPUs offline)

Example 3:

Configure all CPUs online.

```
14:24:42.375 0000FC4 cfall on
14:24:42.375 0000FC4 HHCCP002I CPU0000 thread started: tid=0000CC0, pid=3172, priority=0
14:24:42.375 0000FC4 HHCTT002I Timer thread started: tid=00000A14, pid=3172, priority=-20
14:24:42.375 0000FC4 HHCCP003I CPU0000 architecture mode ESA/390
14:24:42.375 0000FC4 HHCCP002I CPU0001 thread started: tid=0000012C, pid=3172, priority=0
14:24:42.375 0000FC4 HHCCP003I CPU0001 architecture mode ESA/390
14:24:42.375 0000FC4 HHCCP002I CPU0002 thread started: tid=00000390, pid=3172, priority=0
14:24:42.375 0000FC4 HHCCP003I CPU0002 architecture mode ESA/390
14:24:42.375 0000FC4 HHCCP002I CPU0003 thread started: tid=00000E08, pid=3172, priority=0
14:24:42.375 0000FC4 HHCCP003I CPU0003 architecture mode ESA/390
14:24:42.375 0000FC4 HHCCP002I CPU0004 thread started: tid=00000EF4, pid=3172, priority=0
14:24:42.375 0000FC4 HHCCP003I CPU0004 architecture mode ESA/390
14:24:42.375 0000FC4 HHCCP002I CPU0005 thread started: tid=00000FAC, pid=3172, priority=0
14:24:42.375 0000FC4 HHCCP003I CPU0005 architecture mode ESA/390
14:24:42.375 0000FC4 HHCPN154I CPU0000 online
14:24:42.375 0000FC4 HHCPN154I CPU0001 online
14:24:42.375 0000FC4 HHCPN154I CPU0002 online
14:24:42.375 0000FC4 HHCPN154I CPU0003 online
14:24:42.375 0000FC4 HHCPN154I CPU0004 online
14:24:42.375 0000FC4 HHCPN154I CPU0005 online
```

Figure 39: CFALL command (configure all CPUs online)

7.20 CLOCKS (Display TOD clock and CPU timer)

7.20.1 Function

The CLOCKS command is used to display the actual values of the emulators various internal clocks and timers.

7.20.2 Syntax



7.20.3 Parameter

None.

7.20.4 Examples

Example 1:

Display the TOD clock and CPU timer.

```
2007/06/30 14:22:22.137 00000FC4 clocks
2007/06/30 14:22:22.137 00000FC4 HHCPN028I tod = BE23401EA237A000      2005.364 13:22:22.115706
2007/06/30 14:22:22.137 00000FC4          h/w = BE23401EA237A000      2005.364 13:22:22.115706
2007/06/30 14:22:22.137 00000FC4          off = 0000000000000000
2007/06/30 14:22:22.137 00000FC4          ckc = BE23401EA77DD000      2005.364 13:22:22.137309
2007/06/30 14:22:22.137 00000FC4          cpt = 000000000000ED000
```

Figure 40: CLOCKS command

7.21 CMDTGT (Specify the command target)

7.21.1 Function

The CMDTGT command specifies the target environment for all following commands entered on the command line of the Hercules hardware console.

7.21.2 Syntax

Descriptive

CMDTGT {HERC | SCP | PSCP | ?}

Diagram

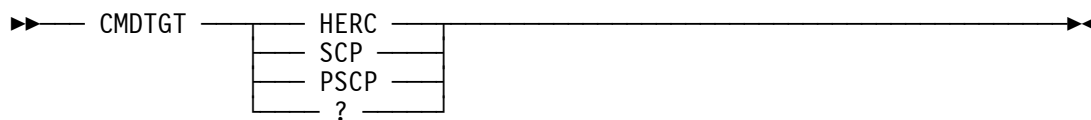

7.21.3 Parameter

HERC	The command target is the Hercules Emulator. This is the default, when no CMDTGT target has been given.
SCP	The target for the commands is the system control program (i.e. the guest operating system running under Hercules).
PSCP	All entered commands are system control program (i.e. guest operating system) priority commands.
?	Display the current target environment for commands.

7.21.4 Examples

Example 1:

Display the current target environment for commands.

```
2008/08/30 09:10:04.390 00000FC4 cmdtgt ?
2008/08/30 09:10:04.390 00000FC4 cmdtgt: Commands are sent to Hercules
```

Figure 41: CMDTGT command (display current setting)

Example 2:

Set the system control program as the target for commands.

```
2008/08/30 09:10:04.390 00000FC4 cmdtgt scp
2008/08/30 09:10:04.390 00000FC4 cmdtgt: Commands are sent to scp
```

Figure 42: CMDTGT command (set target to SCP)

Example 3:

Set the command target from SCP or PSCP back to Hercules (see also HERC command).

```
2008/08/30 09:10:04.390 00000FC4 herc cmdtgt herc
2008/08/30 09:10:04.390 00000FC4 cmdtgt: Commands are sent to Hercules
```

Figure 43: CMDTGT command (set target back to Hercules)

7.22 CONKPALV (Display / alter console TCP/IP keep-alive settings)

7.22.1 Function

The CONKPALV command specifies the tn3270 and telnet client keep-alive option values that control automatic detection of disconnected tn3270 / telnet client sessions.

The arguments *idle*, *intv* and *count* are the new values for the TCP/IP keep-alive settings: Send probe, when the connection goes idle for '*idle*' seconds, wait a maximum of '*intv*' seconds to the response for the probe and disconnect after '*count*' consecutive failed probes.

The CONKPALV command without any operand displays the current values. The format of the CONKPALV command must be exactly as shown, with each value separated from the next by a single comma, no intervening spaces and surrounded by parenthesis.

Some older platforms may ignore all of the values specified and may use platform specific values instead.

7.22.2 Syntax

Descriptive

CONKPALV (*idle*,*intv*,*count*)

Diagram

▶— CONKPALV — (*idle*,*intv*,*count*) —▶

7.22.3 Parameter

- idle** The *idle* value specifies the timeout value in seconds with no activity until the first keep-alive probe is sent. The default for the *idle* value is 3 seconds.
- intv** The *intv* value specifies the interval in seconds between the probes when no acknowledgement is received from the previous one. The default for the *intv* value is 1 second.
- count** The *count* value specifies the number of unacknowledged keep-alive packets sent before the connection is considered to have failed. The default value for the *count* value is 10.

Note: On Windows platforms the *count* value is ignored and cannot be changed from its default value of 10.

7.22.4 Examples

Example 1:

Set the TCP/IP keep-alive settings to 5 seconds idle time, 3 seconds interval between the probes and disconnect after 15 consecutive failed probes.

```
2007/06/30 19:00:30.500 000000E8 conkpalv (5,3,15)
2007/06/30 19:00:30.500 000000E8 HHCPN190I Keep-alive = (5,3,15)
```

Figure 44: CONKPALV command

7.23 CPU (Define target CPU for console displays and commands)

7.23.1 Function

The CPU command sets the target CPU for console displays and commands in a Hercules multi-CPU environment. If the Hercules configuration file sets a single CPU environment, then no CPU command is necessary. If the NUMCPU system parameter in the Hercules configuration file is set greater than one and no CPU command is given, then always the first CPU (CPU 0) is the target for console displays and commands.

7.23.2 Syntax

<p><u>Descriptive</u></p> <p>CPU <i>hh</i></p> <p><u>Diagram</u></p> <p>▶▶ — CPU — <i>hh</i> —————▶▶</p>
--

7.23.3 Parameter

hh The hexadecimal CPU address of the CPU in the multiprocessor configuration which you wish all console commands to apply to. For example, entering “CPU 1” followed by the command “GPR” in a dual CPU configuration will display the general purpose registers for CPU #1 in the configuration, as opposed to CPU #0.

7.23.4 Examples

Example 1:

Display the general purpose registers for CPU #0 in a multiprocessor configuration.

```
16:54:24.781 00000FC4 cpu 0
16:54:31.625 00000FC4 gpr
16:54:31.625 00000FC4 CPU0000: GR00=00000000 GR01=00000000 GR02=0252E12C GR03=02501EB0
16:54:31.625 00000FC4 CPU0000: GR04=02502400 GR05=00000C00 GR06=01379E76 GR07=00000000
16:54:31.625 00000FC4 CPU0000: GR08=0248EF58 GR09=00000000 GR10=0252EF7F GR11=0252DF80
16:54:31.625 00000FC4 CPU0000: GR12=813799C8 GR13=0252DF80 GR14=81379D22 GR15=00000C00
```

Figure 45: CPU command

7.24 CR (Display or alter control registers)

7.24.1 Function

The CR command displays or alters the actual contents of the control registers.

7.24.2 Syntax

Descriptive

CR [*nn=xxxxxxxx* | *nn=xxxxxxxxxxxxxxxxxxxx*]

Diagram

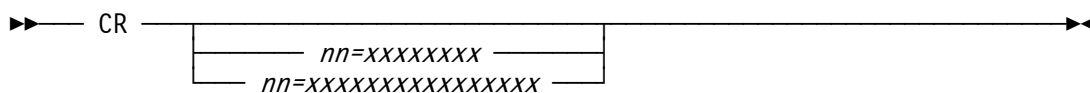

7.24.3 Parameter

- nn** This specifies the optional register number (00-15) to be altered.
- xxxxxxxx** This is the register value in hexadecimal (1-8 hex digits for 32-bit registers, 1-16 hex digits for 64-bit registers).

7.24.4 Examples

Example 1:

Display the control registers.

```
14:22:33.559 00000FC4 cr
14:22:33.559 00000FC4 CPU0000: CR00=5FB1EE40 CR01=3FFFE07F CR02=3F149FC0 CR03=00000001
14:22:33.559 00000FC4 CPU0000: CR04=00010001 CR05=3FFE7040 CR06=FE000000 CR07=3FFFE07F
14:22:33.559 00000FC4 CPU0000: CR08=00000000 CR09=00000000 CR10=00000000 CR11=00000000
14:22:33.559 00000FC4 CPU0000: CR12=01984E80 CR13=3FFFE07F CR14=FF8BF15F CR15=03150010
```

Figure 46: CR command (display control registers)

Example 2:

Alter control register number 15.

```
14:22:33.559 00000FC4 cr 15=FFFFFFFF
14:22:33.559 00000FC4 CPU0000: CR00=5FB1EE40 CR01=3FFFE07F CR02=3F149FC0 CR03=00000001
14:22:33.559 00000FC4 CPU0000: CR04=00010001 CR05=3FFE7040 CR06=FE000000 CR07=3FFFE07F
14:22:33.559 00000FC4 CPU0000: CR08=00000000 CR09=00000000 CR10=00000000 CR11=00000000
14:22:33.559 00000FC4 CPU0000: CR12=01984E80 CR13=3FFFE07F CR14=FF8BF15F CR15=FFFFFFFF
```

Figure 47: CR command (alter control register)

7.25 CSCRIPT (Cancel a running script thread)

7.25.1 Function

The CSCRIPT command will cancel the currently running script. If no script is running, no action is taken.

7.25.2 Syntax

Descriptive

CSCRIPT

Diagram

▶— CSCRIPT —————▶

7.25.3 Parameter

None.

7.25.4 Examples

Example 1:

Cancel the currently running script.

```
2007/06/30 13:13:05.656 00000FC4 cscript
```

Figure 48: CSCRIPT command

7.26 CTC (Enable / disable debug packet tracing)

7.26.1 Function

The CTC command enables or disables the debug packet tracing for the specified CTCI/LCS device group(s) identified by *devnum* or for all CTCI/LCS device group(s) if *devnum* is not specified or specified as ALL.

7.26.2 Syntax

Descriptive

CTC DEBUG {ON | OFF} [*devnum* | ALL]

Diagram

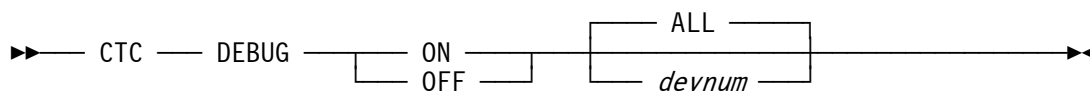

7.26.3 Parameter

- ON** Enables the debug packet tracing.
- OFF** Disables the debug packet tracing.
- devnum** Specifies the CTCI/LCS device group(s) for which debug packet tracing has to be enabled or disabled.
- ALL** Enables or disables the debug packet tracing for all CTCI/LCS device groups. 'ALL' is the default if no device group is specified.

7.26.4 Examples

Example 1:

Enable the debug packet tracing for all CTCI/LCS devices.

```
2008/01/27 19:04:11.375 00000378 ctc debug on
2008/01/27 19:04:11.375 00000378 HHCPNXXI CTC debugging now ON for all CTCI/LCS device groups.
2008/01/27 19:04:30.906 00000378 HHCT046I 0E20: Sending packet to tun0:
2008/01/27 19:04:30.906 00000378 +0000 4500011C 00AC0000 4001F71C C0A80063 E.....@.7.{y.c
2008/01/27 19:04:30.937 00000378 +0010 C0A80065 0800E930 93363000 C1DC84EA {y.e..Z0160.A.d.
2008/01/27 19:04:30.937 00000378 +0020 928D5000 031181A7 7256FAF1 2C74E437 k.P...axrV.1,tU7
2008/01/27 19:04:30.937 00000378 +0030 2E32D6E1 0BB94DC7 32A143D1 796B4E57 .2O...MG2~CJykNW
```

```

2008/01/27 19:04:30.937 00000378 +0040 73E431C1 0A7E75E7 746E90B1 06DD5477 sU1A.~uXtn...Tw
2008/01/27 19:04:30.937 00000378 +0050 2CD450A1 26F97A07 44BA6191 285B7697 ,MP~&9z.D.aj([vp
2008/01/27 19:04:30.937 00000378 +0060 0CC6B381 4932DA27 29903671 3AE634B7 .F.aI2.').6q:W4.
2008/01/27 19:04:30.937 00000378 +0070 5F8EDA61 1BA31647 700B8F51 06EE0ED7 __.a.t.Gp..Q...P
2008/01/27 19:04:30.937 00000378 +0080 77104541 4D32AE67 3A57EC31 625384F7 w.EAM2.g:W.lbSd7
2008/01/27 19:04:30.937 00000378 +0090 593E7421 133A2287 4DB0CD11 12671717 Y>t!:"gM...g..
2008/01/27 19:04:30.937 00000378 +00A0 2E1CE701 6B81F2A7 2061B1F1 6DE94537 ..X.ka2x a.lmZE7
2008/01/27 19:04:30.937 00000378 +00B0 6DBF1DE1 1E429EC7 27C61AD1 3F0A8F57 m...B.G'F.J?..W
2008/01/27 19:04:30.937 00000378 +00C0 4E4898C1 0024A6E7 664987B1 656B7577 NHqA.$wXfIg.ekuw
2008/01/27 19:04:30.937 00000378 +00D0 71ECD7A1 74408B07 39677891 381C7797 q.P~t@..9gxj8.wp
2008/01/27 19:04:30.937 00000378 +00E0 54EF5A81 2E1ECB27 67AB6D71 279E15B7 T.Za...'g.mq'...
2008/01/27 19:04:30.937 00000378 +00F0 7BA3A161 33B7E747 6EB0E651 1FE0CFD7 {t~a3.XGn.WQ.\.P
2008/01/27 19:04:30.937 00000378 +0100 606D2C41 1F745F67 11236331 2A4525F7 `m,A.t_g.#c1*E%7
2008/01/27 19:04:30.937 00000378 +0110 21BF7B21 222CB387 24BE6411 !.{"",.g$.d.
2008/01/27 19:04:30.937 00000378 HHCCT049I 0E20: Received packet from tun0 (284 bytes):
2008/01/27 19:04:30.937 00000378 +0000 4500011C A2570000 80011571 C0A80065 E...sw....q{y.e
2008/01/27 19:04:30.937 00000378 +0010 C0A80063 0000F130 93363000 C1DC84EA {y.c..10160.A.d.
2008/01/27 19:04:30.937 00000378 +0020 928D5000 031181A7 7256FAF1 2C74E437 k.P...axrV.1,tU7
2008/01/27 19:04:30.937 00000378 +0030 2E32D6E1 0BB94DC7 32A143D1 796B4E57 .20...MG2~CJykNW
2008/01/27 19:04:30.937 00000378 +0040 73E431C1 0A7E75E7 746E90B1 06DD5477 sU1A.~uXtn...Tw
2008/01/27 19:04:30.937 00000378 +0050 2CD450A1 26F97A07 44BA6191 285B7697 ,MP~&9z.D.aj([vp
2008/01/27 19:04:30.937 00000378 +0060 0CC6B381 4932DA27 29903671 3AE634B7 .F.aI2.').6q:W4.
2008/01/27 19:04:30.937 00000378 +0070 5F8EDA61 1BA31647 700B8F51 06EE0ED7 __.a.t.Gp..Q...P
2008/01/27 19:04:30.937 00000378 +0080 77104541 4D32AE67 3A57EC31 625384F7 w.EAM2.g:W.lbSd7
2008/01/27 19:04:30.937 00000378 +0090 593E7421 133A2287 4DB0CD11 12671717 Y>t!:"gM...g..
2008/01/27 19:04:30.937 00000378 +00A0 2E1CE701 6B81F2A7 2061B1F1 6DE94537 ..X.ka2x a.lmZE7
2008/01/27 19:04:30.937 00000378 +00B0 6DBF1DE1 1E429EC7 27C61AD1 3F0A8F57 m...B.G'F.J?..W
2008/01/27 19:04:30.937 00000378 +00C0 4E4898C1 0024A6E7 664987B1 656B7577 NHqA.$wXfIg.ekuw
2008/01/27 19:04:30.937 00000378 +00D0 71ECD7A1 74408B07 39677891 381C7797 q.P~t@..9gxj8.wp
2008/01/27 19:04:30.937 00000378 +00E0 54EF5A81 2E1ECB27 67AB6D71 279E15B7 T.Za...'g.mq'...
2008/01/27 19:04:30.937 00000378 +00F0 7BA3A161 33B7E747 6EB0E651 1FE0CFD7 {t~a3.XGn.WQ.\.P
2008/01/27 19:04:30.937 00000378 +0100 606D2C41 1F745F67 11236331 2A4525F7 `m,A.t_g.#c1*E%7
2008/01/27 19:04:30.937 00000378 +0110 21BF7B21 222CB387 24BE6411 !.{"",.g$.d.
2008/01/27 19:04:30.937 00000378 HHCCT041I 0E21: CTC Received Frame (292 bytes):
2008/01/27 19:04:30.937 00000378 +0000 01240122 08000000 4500011C A2570000 .$"...E...sw..
2008/01/27 19:04:30.937 00000378 +0010 80011571 C0A80065 C0A80063 0000F130 ...q{y.e{y.c..10
2008/01/27 19:04:30.937 00000378 +0020 93363000 C1DC84EA 928D5000 031181A7 160.A.d.k.P...ax
2008/01/27 19:04:30.937 00000378 +0030 7256FAF1 2C74E437 2E32D6E1 0BB94DC7 rV.1,tU7.20...MG
2008/01/27 19:04:30.937 00000378 +0040 32A143D1 796B4E57 73E431C1 0A7E75E7 2~CJyknWsu1A.~uX
2008/01/27 19:04:30.937 00000378 +0050 746E90B1 06DD5477 2CD450A1 26F97A07 tn...Tw,MP~&9z.
2008/01/27 19:04:30.937 00000378 +0060 44BA6191 285B7697 0CC6B381 4932DA27 D.aj([vp.F.aI2.'
2008/01/27 19:04:30.937 00000378 +0070 29903671 3AE634B7 5F8EDA61 1BA31647 ).6q:W4.__.a.t.G
2008/01/27 19:04:30.937 00000378 +0080 700B8F51 06EE0ED7 77104541 4D32AE67 p..Q...Pw.EAM2.g
2008/01/27 19:04:30.937 00000378 +0090 3A57EC31 625384F7 593E7421 133A2287 :W.lbSd7Y>t!:"g

```

```

2008/01/27 19:04:30.937 00000378 +00A0 4DB0CD11 12671717 2E1CE701 6B81F2A7 M...g...X.ka2x
2008/01/27 19:04:30.937 00000378 +00B0 2061B1F1 6DE94537 6DBF1DE1 1E429EC7 a.lmZE7m...B.G
2008/01/27 19:04:30.937 00000378 +00C0 27C61AD1 3F0A8F57 4E4898C1 0024A6E7 'F.J?...WNHqA.$wX
2008/01/27 19:04:30.937 00000378 +00D0 664987B1 656B7577 71ECD7A1 74408B07 fIg.ekuwq.P~t@..
2008/01/27 19:04:30.937 00000378 +00E0 39677891 381C7797 54EF5A81 2E1ECB27 9gxj8.wpT.Za...'
2008/01/27 19:04:30.937 00000378 +00F0 67AB6D71 279E15B7 7BA3A161 33B7E747 g.mq'...{t~a3.XG
2008/01/27 19:04:30.937 00000378 +0100 6EB0E651 1FE0CFD7 606D2C41 1F745F67 n.WQ.\.P`m,A.t_g
2008/01/27 19:04:30.937 00000378 +0110 11236331 2A4525F7 21BF7B21 222CB387 .#c1*E%7!.{!",".g
2008/01/27 19:04:30.937 00000378 +0120 24BE6411 $.d.
2008/01/27 19:04:44.406 00000378 HHCCT049I 0E20: Received packet from tun0 (229 bytes):
2008/01/27 19:04:44.421 00000378 +0000 450000E5 02180000 8011B53A C0A80066 E..V.....: {y.f
2008/01/27 19:04:44.421 00000378 +0010 C0A800FF 008A008A 00D1B65E 1102804F {y.....J.^...O
2008/01/27 19:04:44.421 00000378 +0020 C0A80066 008A00BB 00002045 4D454246 {y.f..... EMEBF
2008/01/27 19:04:44.421 00000378 +0030 43454243 41434143 41434143 41434143 CEBACACACACACAC
2008/01/27 19:04:44.421 00000378 +0040 41434143 41434143 41434100 20464445 ACACACACACA. FDE
2008/01/27 19:04:44.421 00000378 +0050 50464345 44454646 43454646 43434143 PFCEDFFCFECCAC
2008/01/27 19:04:44.421 00000378 +0060 41434143 41434143 41434142 4E00FF53 ACACACACACABN..S
2008/01/27 19:04:44.421 00000378 +0070 4D422500 00000000 00000000 00000000 MB%.....
2008/01/27 19:04:44.421 00000378 +0080 00000000 00000000 00000000 00001100 .....
2008/01/27 19:04:44.421 00000378 +0090 00210000 00000000 000000E8 03000000 .!.....Y...
2008/01/27 19:04:44.421 00000378 +00A0 00000000 00210056 00030001 00000002 .....!..V.....
2008/01/27 19:04:44.421 00000378 +00B0 0032005C 4D41494C 534C4F54 5C42524F .2.\MAILSLOT\BRO
2008/01/27 19:04:44.421 00000378 +00C0 57534500 010080FC 0A004C41 52410000 WSE.....LARA..
2008/01/27 19:04:44.421 00000378 +00D0 00000000 24000000 00000501 02100000 ....$.
2008/01/27 19:04:44.421 00000378 +00E0 0F0155AA 00 ..U..
.
.
.

```

Figure 49: CTC command

7.27 DEFINE (Rename device)

7.27.1 Function

The DEFINE command can be used to “rename” a device (change the device number).

7.27.2 Syntax

Descriptive

```
DEFINE olddevice newdevice
```

Diagram

```
▶— DEFINE — olddevice — newdevice —▶
```

7.27.3 Parameter

olddevice The device number of the device that has to be renamed.

newdevice The new device number, to which the device should now be attached.

7.27.4 Examples

Example 1:

Rename two devices.

```
2007/06/30 14:31:59.718 00000FC4 define 0704 0705
2007/06/30 14:32:20.328 00000FC4 define 0a8c 0a8d
```

Figure 50: DEFINE command

7.28 DEFSYM (Define symbol)

7.28.1 Function

The DEFSYM command defines symbol *symbol* as to contain value *value*. The symbol can be the object of a substitution. If the *value* contains blanks or spaces then it must be enclosed within quotes or apostrophes. See chapter “Symbol Substitutions” for a more in-depth discussion on this feature.

7.28.2 Syntax

Descriptive

DEFSYM [*symbol* [*value*]]

Diagram

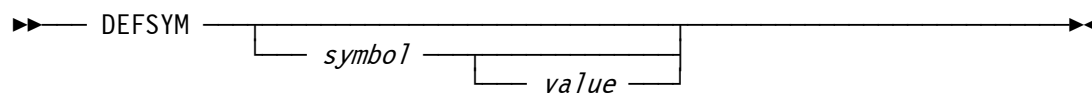

7.28.3 Parameter

symbol The name of a symbol. If no symbol name (and optionally a value) is given then all previously defined symbols are listed.

value The value that is assigned to the symbol. If the value is omitted then the previously defined symbol is cleared, the symbol itself is not deleted.

7.28.4 Examples

Example 1:

List all defined symbols.

```
2007/06/30 12:44:06.890 00000FC4 defsym
2007/06/30 12:44:06.890 00000FC4 HHCPN042I CUU=$(CUU)
2007/06/30 12:44:06.890 00000FC4 HHCPN042I cuu=$(cuu)
2007/06/30 12:44:06.890 00000FC4 HHCPN042I CCUU=$(CCUU)
2007/06/30 12:44:06.890 00000FC4 HHCPN042I ccuu=$(ccuu)
2007/06/30 12:44:06.890 00000FC4 HHCPN042I DASDPATH=D:/MVS/DASD_CCKD
2007/06/30 12:44:06.890 00000FC4 HHCPN042I CSS=0
```

Figure 51: DEFSYM command (list all symbols)

Example 2:

Define new symbol (and list the symbols afterwards).

```
2007/06/30 12:44:36.187 00000ED0 defsym tapedir "/home/hercules/tapes"
2007/06/30 12:44:42.296 00000ED0 defsym
2007/06/30 12:44:42.296 00000ED0 HHCPN042I CUU=$(CUU)
2007/06/30 12:44:42.296 00000ED0 HHCPN042I cuu=$(cuu)
2007/06/30 12:44:42.296 00000ED0 HHCPN042I CCUU=$(CCUU)
2007/06/30 12:44:42.296 00000ED0 HHCPN042I ccuu=$(ccuu)
2007/06/30 12:44:42.296 00000ED0 HHCPN042I CSS=0
2007/06/30 12:44:42.296 00000ED0 HHCPN042I tapedir="/home/hercules/tapes"
```

Figure 52: DEFSYM command (define new symbol)

Example 3:

Clear defined symbol.

```
2007/06/30 12:44:49.281 00000ED0 defsym tapedir
2007/06/30 12:44:52.625 00000ED0 defsym
2007/06/30 12:44:52.625 00000ED0 HHCPN042I CUU=$(CUU)
2007/06/30 12:44:52.625 00000ED0 HHCPN042I cuu=$(cuu)
2007/06/30 12:44:52.625 00000ED0 HHCPN042I CCUU=$(CCUU)
2007/06/30 12:44:52.625 00000ED0 HHCPN042I ccuu=$(ccuu)
2007/06/30 12:44:52.625 00000ED0 HHCPN042I CSS=0
2007/06/30 12:44:52.625 00000ED0 HHCPN042I tapedir=
```

Figure 53: DEFSYM command (clear defined symbol)

7.29 DETACH (Remove device)

7.29.1 Function

The DETACH command removes a device from the current configuration. The effect of this command is immediately visible in the device display of the Hercules Windows GUI and the Hercules “Peripherals” display.

7.29.2 Syntax

Descriptive

DETACH *device*

Diagram

▶— DETACH — *device* —————▶

7.29.3 Parameter

device The device number of the device that is to be removed from the current configuration.

7.29.4 Examples

Example 1:

Detach device 000F from the active configuration.

```
2007/06/30 13:31:32.187 00000FC4 detach 000f
2007/06/30 13:31:32.187 00000FC4 HHCCF047I Device 000F detached
```

Figure 54: DETACH command

7.30 DEVINIT (Reinitialize device)

7.30.1 Function

The DEVINIT command can be used to reopen an existing device. The arguments (if any) override the arguments specified in the configuration file for this device. If no arguments (beneath the device number) are given, then the DEVINIT command will reinitialise the device with the same arguments that were previously specified. The device type cannot be changed and must not be specified.

This command can be used to rewind a tape, to mount a new tape or disk image file on an existing device, to load a new card deck into a reader, or to close and reopen a printer or punch device.

7.30.2 Syntax

Descriptive

```
DEVINIT devnum [argument [argument ... ]]
```

Diagram

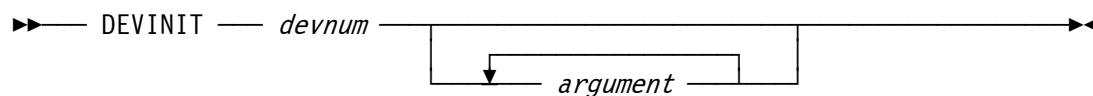

7.30.3 Parameter

devnum The device number of the device to be reinitialized.

argument Any arguments that are acceptable for the kind of device being reinitialized.

7.30.4 Examples

Example 1:

Initialize a tape device.

```
00000FC4 devinit 0561 D:/MVS/TAPE/TST001.HET chunksize=65535 compress=1 method=1 level=4
00000FC4 HHCTA998I Device 0561 : D:/MVS/TAPE/TST001.HET is a Hercules Formatted Tape
00000FC4 XXXXXXXXXX Device 0561 : parameter: 'chunksize=65535'
00000FC4 XXXXXXXXXX Device 0561 : parameter: 'compress=1'
00000FC4 XXXXXXXXXX Device 0561 : parameter: 'method=1'
00000FC4 XXXXXXXXXX Device 0561 : parameter: 'level=4'
00000FC4 HHCTA100I 0561: Now Displays: " NT RDY "
00000FC4 HHCPN098I Device 0561 initialized
```

Figure 55: DEVINIT command

7.31 DEVLIST (List device or all devices)

7.31.1 Function

The DEVLIST command lists all the devices that are defined in the active Hercules configuration and displays their current status.

7.31.2 Syntax

Descriptive

DEVLIST

Diagram

▶— DEVLIST —————▶

7.31.3 Parameter

None.

7.31.4 Examples

Example 1:

List all devices of the current configuration.

```
2007/05/30 23:07:22.181 00000F28 devlist
2007/05/30 23:07:22.197 00000F28 0:000C 3505 D://MVS/JCL/DUMMY.JCL ascii eof open
2007/05/30 23:07:22.197 00000F28 0:000D 3525 D://MVS/PCH/pch00d.txt ascii crlf open
2007/05/30 23:07:22.197 00000F28 0:000E 1403 D://MVS/PRT/prt00e.txt crlf open
2007/05/30 23:07:22.197 00000F28 0:000F 1403 D://MVS/PRT/prt00f.txt crlf open
2007/05/30 23:07:22.197 00000F28 0:0010 3270 192.168.0.101 open
2007/05/30 23:07:22.197 00000F28 0:0011 3270 192.168.0.101 open
2007/05/30 23:07:22.197 00000F28 0:00C0 3270 192.168.0.101 open
2007/05/30 23:07:22.197 00000F28 0:00C1 3270 192.168.0.101 open
2007/05/30 23:07:22.197 00000F28 0:00C2 3270 192.168.0.101 open
2007/05/30 23:07:22.197 00000F28 0:00C3 3270
2007/05/30 23:07:22.197 00000F28 0:00C4 3270
2007/05/30 23:07:22.197 00000F28 0:00C5 3270
2007/05/30 23:07:22.197 00000F28 0:00C6 3270
2007/05/30 23:07:22.197 00000F28 0:00C7 3270
2007/05/30 23:07:22.197 00000F28 0:0130 2314 D://MVS/DASD/SORT00.130c [200 cyls] open
2007/05/30 23:07:22.197 00000F28 0:0131 2314 D://MVS/DASD/SORT01.131c [200 cyls] open
2007/05/30 23:07:22.197 00000F28 0:0132 2314 D://MVS/DASD/SORT02.132c [203 cyls] open
2007/05/30 23:07:22.197 00000F28 0:0133 2314 D://MVS/DASD/SORT03.133c [200 cyls] open
```

```

2007/05/30 23:07:22.197 00000F28 0:0134 2314 D://MVS/DASD/SORT04.134c [200 cyls] open
2007/05/30 23:07:22.197 00000F28 0:0135 2314 D://MVS/DASD/SORT05.135c [200 cyls] open
2007/05/30 23:07:22.197 00000F28 0:0140 3350 D://MVS/DASD/WORK00.140c [555 cyls] open
2007/05/30 23:07:22.197 00000F28 0:0141 3350 D://MVS/DASD/WORK01.141c [555 cyls] open
2007/05/30 23:07:22.197 00000F28 0:0142 3350 D://MVS/DASD/PRD000.142c [560 cyls] open
2007/05/30 23:07:22.197 00000F28 0:0143 3350 D://MVS/DASD/PRD001.143c [560 cyls] open
2007/05/30 23:07:22.197 00000F28 0:0144 3350 D://MVS/DASD/PRD002.144c [560 cyls] open
2007/05/30 23:07:22.197 00000F28 0:0145 3350 D://MVS/DASD/PRD003.145c [560 cyls] open
2007/05/30 23:07:22.197 00000F28 0:0148 3350 D://MVS/DASD/MVSRES.148c [560 cyls] open
2007/05/30 23:07:22.197 00000F28 0:0149 3350 D://MVS/DASD/MVSDLB.149c [555 cyls] open
2007/05/30 23:07:22.197 00000F28 0:0160 3340 D://MVS/DASD/PAGE00.160c [698 cyls] open
2007/05/30 23:07:22.197 00000F28 0:0161 3340 D://MVS/DASD/PAGE01.161c [698 cyls] open
2007/05/30 23:07:22.197 00000F28 0:0240 3350 D://MVS/DASD/PUB000.240c [555 cyls] open
2007/05/30 23:07:22.197 00000F28 0:0241 3350 D://MVS/DASD/PUB001.241c [555 cyls] open
2007/05/30 23:07:22.197 00000F28 0:0242 3350 D://MVS/DASD/PUB002.242c [560 cyls] open
2007/05/30 23:07:22.197 00000F28 0:0243 3350 D://MVS/DASD/PUB003.243c [560 cyls] open
2007/05/30 23:07:22.197 00000F28 0:0248 3350 D://MVS/DASD/SYS000.248c [560 cyls] open
2007/05/30 23:07:22.197 00000F28 0:0249 3350 D://MVS/DASD/SYS001.249c [560 cyls] open
2007/05/30 23:07:22.197 00000F28 0:024A 3350 D://MVS/DASD/SYS002.24Ac [560 cyls] open
2007/05/30 23:07:22.197 00000F28 0:024B 3350 D://MVS/DASD/SYS003.24Bc [560 cyls] open
2007/05/30 23:07:22.197 00000F28 0:030E 1403 D://MVS/LOG/hardcopy.log crlf open
2007/05/30 23:07:22.197 00000F28 0:0340 3350 D://MVS/DASD/CBT000.340c [555 cyls] open
2007/05/30 23:07:22.197 00000F28 0:0341 3350 D://MVS/DASD/CBT001.341c [555 cyls] open
2007/05/30 23:07:22.197 00000F28 0:0342 3350 D://MVS/DASD/CBT002.342c [555 cyls] open
2007/05/30 23:07:22.197 00000F28 0:0343 3350 D://MVS/DASD/CBT003.343c [555 cyls] open
2007/05/30 23:07:22.197 00000F28 0:0344 3350 D://MVS/DASD/SPOOL0.344c [560 cyls] open
2007/05/30 23:07:22.197 00000F28 0:0345 3350 D://MVS/DASD/SPOOL1.345c [560 cyls] open
2007/05/30 23:07:22.197 00000F28 0:0348 3350 D://MVS/DASD/TST000.348c [560 cyls] open
2007/05/30 23:07:22.197 00000F28 0:0349 3350 D://MVS/DASD/TST001.349c [560 cyls] open
2007/05/30 23:07:22.197 00000F28 0:034A 3350 D://MVS/DASD/TST002.34Ac [560 cyls] open
2007/05/30 23:07:22.197 00000F28 0:034B 3350 D://MVS/DASD/TST003.34Bc [560 cyls] open
2007/05/30 23:07:22.197 00000F28 0:0480 3420 *

```

Figure 56: DEVLIST command

7.32 DEVTMAX (Display or set maximum device threads)

7.32.1 Function

The DEVTMAX command displays the current setting of the DEVTMAX system parameter along with the actual device threads statistics. As an additional argument a new value for the maximum device threads may be specified.

7.32.2 Syntax

Descriptive

DEVTMAX [-1 | 0 | 1-n]

Diagram

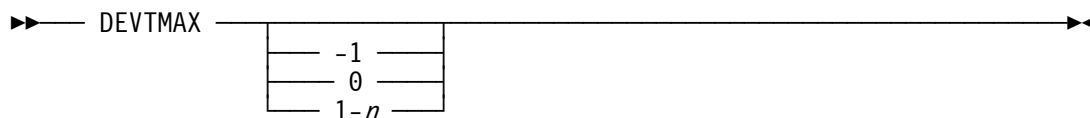

7.32.3 Parameter

- 1** Specify -1 to cause 'one time only' temporary threads to be created to service each I/O request to a device. Once the I/O request is complete the thread exits. Subsequent I/Os to the same device will cause another worker thread to be created again.
- 0** Specify 0 to cause an unlimited number of 'semi-permanent' threads to be created on an 'as-needed' basis. With this option a thread is created to service an I/O request for a device if one does not already exist. When the I/O is complete then the thread enters an idle state waiting for new work. If a new I/O request for the device arrives before the timeout period expires, the existing thread will be reused. The timeout value is currently hard coded at 5 minutes.

Note that this option can cause one thread (or possibly more) to be created for each device in your configuration. Specifying 0 means there is no limit to the number of threads that can be created.
- 1-n** Specify a value from 1 to n to set an upper limit to the number of threads that can be created to service any I/O request to any device. Like the "0" option, each thread, once done servicing an I/O request enters an idle state. If a new request arrives before the timeout period expires the thread is reused. If all threads are busy when a new I/O request arrives, a new thread is created only if the specified maximum number of threads have not yet been reached. If the specified maximum number of threads already has been reached then the I/O request is placed in a queue and will be serviced by the first available thread (i.e. whichever thread becomes idle first).

This option was created to address a threading issue, possibly related to the Cygwin pthreads implementation on Windows systems. The default for Windows is 8. The default for all other systems is 0.

7.32.4 Examples

Example 1:

Display the maximum allowed device threads along with the current statistics.

```
00000FC4 devtmax
00000FC4 HHCPN076I Max device threads: 0, current: 2, most: 5, waiting: 0, max exceeded: 0
```

Figure 57: DEVTMAX command (list maximum device threads)

Example 2:

Set a new value for the maximum allowed device threads.

```
00000FC4 devtmax 25
00000FC4 HHCPN076I Max device threads: 25, current: 2, most: 5, waiting: 0, max exceeded: 0
```

Figure 58: DEVTMAX command (set maximum device threads)

7.33 DS (Display subchannel)

7.33.1 Function

The DS command shows the subchannel information for a given device number.

7.33.2 Syntax

Descriptive

DS *devnum*

Diagram

▶— DS — *devnum* —▶

7.33.3 Parameter

devnum The device number, for which the subchannel information has to be displayed.

7.33.4 Examples

Example 1:

Display subchannel information for device 0AE0.

```
000009EC ds 0ae0
000009EC 0AE0:D/T=3390 Subchannel_Number=0028
000009EC      PMCW=IntParm:00F3F8A8 Flags:1899 Dev:0AE0 LPM:80 PNOM:00 LPUM:80 PIM:80
000009EC      MBI:0183 POM:FF PAM:80 CHPIDs:0A00000000000000 Misc:00000001
000009EC      SCSW=Flags:08C0 SCHC:4020 Stat:0000 Count:0001 CCW:3727CCF0
```

Figure 59: DS command

7.33.5 Explanations

The information presented in the output from the Display Subchannel command is taken from the Subchannel-Information Block (SCHIB). The Subchannel-Information Block shows - beneath other areas - the Path-Management-Control Word (PMCW) and the Subchannel-Status Word (SCSW). The format of the SCHIB is shown on the following page.

Word	
0	Path-Management-Control Word
1	
2	
3	
4	
5	
6	
7	Subchannel-Status Word
8	
9	
10	Model-Dependent Area / Measurement-Block Address
11	
12	Model-Dependent Area

Figure 60: Subchannel-Information Block

Words 0-6 of the SCHIB contain the Path-Management-Control Word (PMCW). The format of the PMCW is the following:

Word	Interruption Parameter																	
0																		
1	00	ISC	000	E	LM	MM	D	T	V	Device Number								
2	LPM			PNOM				LPUM			PIM							
3	MBI						POM			PAM								
4	CHPID-0			CHPID-1				CHPID-2			CHPID-3							
5	CHPID-4			CHPID-5				CHPID-6			CHPID-7							
6	0	0	0	0	0	0	0	0	0	0	0	0	0	0	0	F	X	S

Figure 61: Path-Management-Control Word

Legend:

- ISC Interruption-Subclass Code
- E Enabled
- LM Limit Mode
- MM Measurement-Mode Enable
- D Multipath Mode
- T Timing Facility
- V Device Number Valid
- LPM Logical-Path Mask
- PNOM Path-Not-Operational Mask
- LPUM Last-Path-Used Mask
- PIM Path-Installed Mask
- MBI Measurement-Block Index
- POM Path-Operational Mask

- PAM Path-Available Mask
- CHPIDs Channel-Path Identifiers
- F Measurement Block Format Control
- X Extended Measurement Word Enable
- S Concurrent Sense

The Subchannel-Status Word (SCSW) provides information about the status of a subchannel and its associated devices. The format of the SCSW is as follows:

Word																
0	Key	S	L	CC	F	P	I	A	U	Z	E	N	0	FC	AC	SC
1	CCW Address															
2	Device Status				Subchannel Status				Count							

Figure 62: Subchannel-Status Word

Legend:

- Key Subchannel Key
- S Suspend Control
- L ESW Format
- CC Deferred Condition Code
- F Format
- P Prefetch
- I Initial-Status Interruption Control
- A Address-Limit-Checking Control
- U Suppress-Suspend Interruption
- Z Zero Condition Code
- E Extended Control
- N Path Not Operational
- 0 Reserved
- FC Function Control
- AC Activity Control
- SC Status Control
- Count Residual Count

Details about the control blocks, that have been described here only briefly, can be found in IBM's "z/Architecture Principles of Operation" manual.

7.34 ECPSVM (ECPS:VM commands)

7.34.1 Function

The ECPSVM command invokes ECPS:VM subcommands (described below). Issuing command ECPSVM HELP displays a list of all available commands.

7.34.2 Syntax

Descriptive

ECPSVM [HELP | STATS | DISABLE | ENABLE | DEBUG | NODEBUG | LEVEL [*nn*]]

or (with abbreviated arguments)

ECPSVM [H | ST | DIS | EN | DEBUG | NO | L [*nn*]]

Diagram

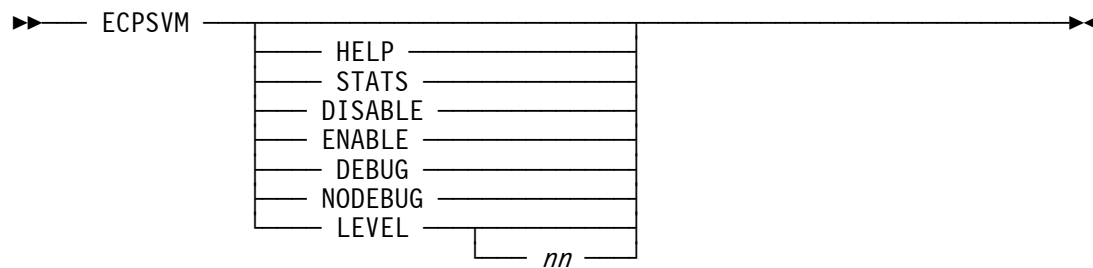

or (with abbreviated arguments)

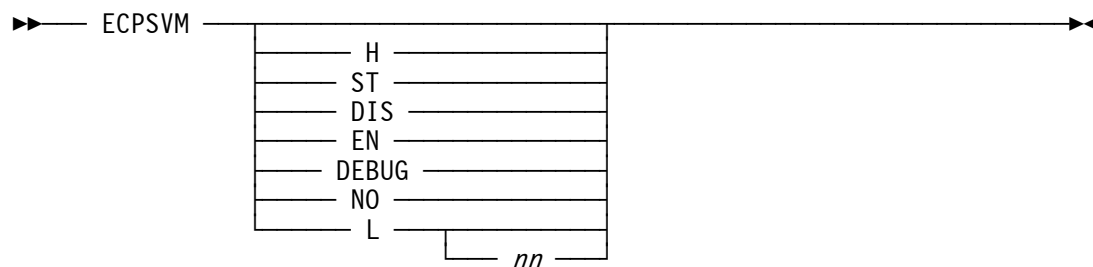

7.34.3 Parameter

HELP	Show the help panel with all available commands.
STATS	Show statistical counters.
DISABLE	Disable all ECPS:VM features.
ENABLE	Enable all ECPS:VM features.
DEBUG	Debug ECPS:VM features.
NODEBUG	Turn debug modus off for ECPS:VM features.
LEVEL	Set/show ECPS:VM level.
nn	The value nn specifies the support level that is reported to the operating system.

7.34.4 Examples

Example 1:

Show ECPS:VM statistical counters.

```
2007/06/30 17:16:05.656 00000FC4 ecpsvm stats
2007/06/30 17:16:05.656 00000FC4 HHCEV011I ECPS:VM Command processor invoked
2007/06/30 17:16:05.656 00000FC4 HHCEV003I +-----+-----+-----+-----+
2007/06/30 17:16:05.656 00000FC4 HHCEV002I | VM ASSIST | Calls   | Hits   | Ratio |
2007/06/30 17:16:05.656 00000FC4 HHCEV003I +-----+-----+-----+-----+
2007/06/30 17:16:05.656 00000FC4 HHCEV001I | Total   |      0 |      0 | 100% |
2007/06/30 17:16:05.656 00000FC4 HHCEV003I +-----+-----+-----+-----+
2007/06/30 17:16:05.656 00000FC4 HHCEV005I 11 Entries not shown (never invoked)
2007/06/30 17:16:05.656 00000FC4 HHCEV003I +-----+-----+-----+-----+
2007/06/30 17:16:05.656 00000FC4 HHCEV002I | CP ASSIST | Calls   | Hits   | Ratio |
2007/06/30 17:16:05.656 00000FC4 HHCEV003I +-----+-----+-----+-----+
2007/06/30 17:16:05.656 00000FC4 HHCEV001I | Total   |      0 |      0 | 100% |
2007/06/30 17:16:05.656 00000FC4 HHCEV003I +-----+-----+-----+-----+
2007/06/30 17:16:05.656 00000FC4 HHCEV005I 23 Entries not shown (never invoked)
2007/06/30 17:16:05.656 00000FC4 HHCEV011I ECPS:VM Command processor complete
```

Figure 63: ECPSVM STATS command

Example 2:

Enable the ECPS:VM features.

```
2007/06/30 17:16:55.468 00000FC4 ecpsvm enable
2007/06/30 17:16:55.468 00000FC4 HHCEV011I ECPS:VM Command processor invoked
2007/06/30 17:16:55.468 00000FC4 HHCEV015I ECPS:VM VM ASSIST feature SVC Enabled
2007/06/30 17:16:55.468 00000FC4 HHCEV015I ECPS:VM VM ASSIST feature SSM Enabled
2007/06/30 17:16:55.468 00000FC4 HHCEV015I ECPS:VM VM ASSIST feature LPSW Enabled
2007/06/30 17:16:55.468 00000FC4 HHCEV015I ECPS:VM VM ASSIST feature STNSM Enabled
2007/06/30 17:16:55.468 00000FC4 HHCEV015I ECPS:VM VM ASSIST feature STOSM Enabled
2007/06/30 17:16:55.468 00000FC4 HHCEV015I ECPS:VM VM ASSIST feature SIO Enabled
2007/06/30 17:16:55.468 00000FC4 HHCEV015I ECPS:VM VM ASSIST feature VTIMER Enabled
2007/06/30 17:16:55.468 00000FC4 HHCEV015I ECPS:VM VM ASSIST feature STCTL Enabled
2007/06/30 17:16:55.468 00000FC4 HHCEV015I ECPS:VM VM ASSIST feature LCTL Enabled
```

```

2007/06/30 17:16:55.468 00000FC4 HHCEV015I ECPS:VM VM ASSIST feature DIAG Enabled
2007/06/30 17:16:55.468 00000FC4 HHCEV015I ECPS:VM VM ASSIST feature IUCV Enabled
2007/06/30 17:16:55.468 00000FC4 HHCEV016I All ECPS:VM VM ASSIST features Enabled
2007/06/30 17:16:55.468 00000FC4 HHCEV015I ECPS:VM CP ASSIST feature FREE Enabled
2007/06/30 17:16:55.468 00000FC4 HHCEV015I ECPS:VM CP ASSIST feature FRET Enabled
2007/06/30 17:16:55.468 00000FC4 HHCEV015I ECPS:VM CP ASSIST feature LCKPG Enabled
2007/06/30 17:16:55.468 00000FC4 HHCEV015I ECPS:VM CP ASSIST feature ULKPG Enabled
2007/06/30 17:16:55.468 00000FC4 HHCEV015I ECPS:VM CP ASSIST feature SCNRU Enabled
2007/06/30 17:16:55.468 00000FC4 HHCEV015I ECPS:VM CP ASSIST feature SCNVU Enabled
2007/06/30 17:16:55.468 00000FC4 HHCEV015I ECPS:VM CP ASSIST feature DISP0 Enabled
2007/06/30 17:16:55.468 00000FC4 HHCEV015I ECPS:VM CP ASSIST feature DISP1 Enabled
2007/06/30 17:16:55.468 00000FC4 HHCEV015I ECPS:VM CP ASSIST feature DISP2 Enabled
2007/06/30 17:16:55.468 00000FC4 HHCEV015I ECPS:VM CP ASSIST feature DNCCW Enabled
2007/06/30 17:16:55.468 00000FC4 HHCEV015I ECPS:VM CP ASSIST feature DFCCW Enabled
2007/06/30 17:16:55.468 00000FC4 HHCEV015I ECPS:VM CP ASSIST feature FCCWS Enabled
2007/06/30 17:16:55.468 00000FC4 HHCEV015I ECPS:VM CP ASSIST feature CCWGN Enabled
2007/06/30 17:16:55.468 00000FC4 HHCEV015I ECPS:VM CP ASSIST feature UXCCW Enabled
2007/06/30 17:16:55.468 00000FC4 HHCEV015I ECPS:VM CP ASSIST feature TRBRG Enabled
2007/06/30 17:16:55.468 00000FC4 HHCEV015I ECPS:VM CP ASSIST feature TRLOK Enabled
2007/06/30 17:16:55.468 00000FC4 HHCEV015I ECPS:VM CP ASSIST feature VIST Enabled
2007/06/30 17:16:55.468 00000FC4 HHCEV015I ECPS:VM CP ASSIST feature VIPT Enabled
2007/06/30 17:16:55.468 00000FC4 HHCEV015I ECPS:VM CP ASSIST feature STEVL Enabled
2007/06/30 17:16:55.468 00000FC4 HHCEV015I ECPS:VM CP ASSIST feature FREEX Enabled
2007/06/30 17:16:55.468 00000FC4 HHCEV015I ECPS:VM CP ASSIST feature FRETX Enabled
2007/06/30 17:16:55.468 00000FC4 HHCEV015I ECPS:VM CP ASSIST feature PMASS Enabled
2007/06/30 17:16:55.468 00000FC4 HHCEV015I ECPS:VM CP ASSIST feature LCSPG Enabled
2007/06/30 17:16:55.468 00000FC4 HHCEV016I All ECPS:VM CP ASSIST features Enabled
2007/06/30 17:16:55.468 00000FC4 HHCEV011I ECPS:VM Command processor complete

```

Figure 64: ECPSVM ENABLE command

Example 3:

Show the ECPS:VM level.

```

2007/06/30 17:16:40.843 00000FC4 ecpsvm level
2007/06/30 17:16:40.843 00000FC4 HHCEV011I ECPS:VM Command processor invoked
2007/06/30 17:16:40.843 00000FC4 HHCEV016I Current reported ECPS:VM Level is 0
2007/06/30 17:16:40.843 00000FC4 HHCEV017I But ECPS:VM is currently disabled
2007/06/30 17:16:40.843 00000FC4 HHCEV017W WARNING ! current level (0) is not supported
2007/06/30 17:16:40.843 00000FC4 HHCEV018W WARNING ! Unpredictable results may occur
2007/06/30 17:16:40.843 00000FC4 HHCEV019I The microcode support level is 20
2007/06/30 17:16:40.843 00000FC4 HHCEV011I ECPS:VM Command processor complete

```

Figure 65: ECPSVM LEVEL command

7.35 EXIT (Terminate the emulator)

7.35.1 Function

The EXIT command (see also the QUIT command) initiates the Hercules shutdown. It terminates all threads, detaches all channels and devices and releases the configuration. Finally it terminates the emulator.

7.35.2 Syntax



7.35.3 Parameter

None.

7.35.4 Examples

Example 1:

Initiate the Hercules shutdown.

```
2007/06/30 2007/06/30 14:49:57.044 00000FC4 exit
2007/06/30 2007/06/30 14:49:57.044 00000FC4 HHCIN900I Begin Hercules shutdown
2007/06/30 2007/06/30 14:49:57.044 00000FC4 HHCIN901I Releasing configuration
2007/06/30 2007/06/30 14:49:57.044 00000FC4 HHCCP008I CPU0000 thread ended: tid=0000049C,pid=232
2007/06/30 2007/06/30 14:49:57.044 00000FC4 HHCCP008I CPU0001 thread ended: tid=0000046C,pid=232
2007/06/30 2007/06/30 14:49:57.044 00000FC4 HHCCF047I Subchannel 0000 detached
2007/06/30 2007/06/30 14:49:57.044 00000FC4 HHCCF047I Subchannel 0001 detached
2007/06/30 2007/06/30 14:49:57.044 00000FC4 HHCCF047I Subchannel 0002 detached
2007/06/30 2007/06/30 14:49:57.059 00000FC4 HHCTT003I Timer thread ended
2007/06/30 2007/06/30 14:49:57.059 00000FC4 HHCCF047I Subchannel 0003 detached
2007/06/30 2007/06/30 14:49:57.059 00000FC4 HHCCF047I Subchannel 0004 detached
2007/06/30 2007/06/30 14:49:57.059 00000FC4 HHCCF047I Subchannel 0005 detached
2007/06/30 2007/06/30 14:49:57.059 00000FC4 HHCCF047I Subchannel 0006 detached
2007/06/30 2007/06/30 14:49:57.059 00000FC4 HHCCF047I Subchannel 0007 detached
2007/06/30 2007/06/30 14:49:57.059 00000FC4 HHCCF047I Subchannel 0008 detached
2007/06/30 2007/06/30 14:49:57.059 00000FC4 HHCCF047I Subchannel 0009 detached
2007/06/30 2007/06/30 14:49:57.059 00000FC4 HHCCF047I Subchannel 000A detached
```

```

2007/06/30 2007/06/30 14:49:57.059 00000FC4 HHCCF047I Subchannel 000B detached
2007/06/30 2007/06/30 14:49:57.059 00000FC4 HHCCF047I Subchannel 000C detached
2007/06/30 2007/06/30 14:49:57.059 00000FC4 HHCCF047I Subchannel 000D detached
2007/06/30 2007/06/30 14:49:57.059 00000FC4 HHCCF047I Subchannel 000E detached
2007/06/30 2007/06/30 14:49:57.059 00000FC4 HHCCF047I Subchannel 000F detached
2007/06/30 2007/06/30 14:49:57.059 00000FC4 HHCCF047I Subchannel 0010 detached
2007/06/30 2007/06/30 14:49:57.059 00000FC4 HHCCF047I Subchannel 0011 detached
2007/06/30 2007/06/30 14:49:57.059 00000FC4 HHCCF047I Subchannel 0012 detached
2007/06/30 2007/06/30 14:49:57.059 00000FC4 HHCCF047I Subchannel 0013 detached
2007/06/30 2007/06/30 14:49:57.059 00000FC4 HHCTE004I Console connection thread terminated
2007/06/30 2007/06/30 14:49:57.059 00000FC4 HHCD A023I 0300 cache hits 812, misses 114, waits 0
2007/06/30 2007/06/30 14:49:57.059 00000FC4 HHCCF047I Subchannel 0014 detached
2007/06/30 2007/06/30 14:49:57.059 00000FC4 HHCD A023I 0310 cache hits 5, misses 7, waits 0
2007/06/30 2007/06/30 14:49:57.059 00000FC4 HHCCF047I Subchannel 0015 detached
2007/06/30 2007/06/30 14:49:57.059 00000FC4 HHCD A023I 0320 cache hits 271, misses 35, waits 0
2007/06/30 2007/06/30 14:49:57.059 00000FC4 HHCCF047I Subchannel 0016 detached
2007/06/30 2007/06/30 14:49:57.059 00000FC4 HHCD A023I 0330 cache hits 137, misses 59, waits 0
2007/06/30 2007/06/30 14:49:57.059 00000FC4 HHCCF047I Subchannel 0017 detached
.
.
.
2007/06/30 2007/06/30 14:49:57.075 00000FC4 HHCCF047I Subchannel 0028 detached
2007/06/30 2007/06/30 14:49:57.075 00000FC4 HHCCF047I Subchannel 0029 detached
2007/06/30 2007/06/30 14:49:57.075 00000FC4 HHCCF047I Subchannel 002A detached
2007/06/30 2007/06/30 14:49:57.075 00000FC4 HHCCF047I Subchannel 002B detached
2007/06/30 2007/06/30 14:49:57.075 00000FC4 HHCCF047I Subchannel 002C detached
2007/06/30 2007/06/30 14:49:57.075 00000FC4 HHCCF047I Subchannel 002D detached
2007/06/30 2007/06/30 14:49:57.075 00000FC4 HHCCF047I Subchannel 002E detached
2007/06/30 2007/06/30 14:49:59.841 00000FC4 HHCCF047I Subchannel 002F detached
2007/06/30 2007/06/30 14:49:59.841 00000FC4 HHCIN902I Configuration release complete
2007/06/30 2007/06/30 14:49:59.841 00000FC4 HHCIN903I Calling termination routines
2007/06/30 2007/06/30 14:49:59.841 00000FC4 HHCHD900I Begin shutdown sequence
2007/06/30 2007/06/30 14:49:59.841 00000FC4 HHCHD901I Calling console_shutdown
2007/06/30 2007/06/30 14:49:59.841 00000FC4 HHCHD902I console_shutdown complete
2007/06/30 2007/06/30 14:49:59.841 00000FC4 HHCHD901I Calling hdl_term
2007/06/30 2007/06/30 14:49:59.841 00000FC4 HHCHD950I Begin HDL termination sequence
2007/06/30 2007/06/30 14:49:59.841 00000FC4 HHCHD951I Calling module dyngui cleanup routine
2007/06/30 2007/06/30 14:49:59.950 00000FC4 HHCHD952I Module dyngui cleanup complete
2007/06/30 2007/06/30 14:49:59.950 00000FC4 HHCHD951I Calling module *Hercules cleanup routine
2007/06/30 2007/06/30 14:49:59.950 00000FC4 HHCHD952I Module *Hercules cleanup complete
2007/06/30 2007/06/30 14:49:59.950 00000FC4 HHCHD959I HDL Termination sequence complete
2007/06/30 2007/06/30 14:49:59.950 00000FC4 HHCHD902I hdl_term complete
2007/06/30 2007/06/30 14:49:59.950 00000FC4 HHCHD901I Calling logger_term
2007/06/30 2007/06/30 14:49:59.950 00000FC4 HHCLG014I logger thread terminating
2007/06/30 2007/06/30 14:49:59.950 00000FC4 HHCLG014I logger thread terminating
2007/06/30 2007/06/30 14:49:59.950 00000FC4 HHCIN099I Hercules terminated

```

Figure 66: EXIT command

7.36 EXT (Generate external interrupt)

7.36.1 Function

The EXT command generates an external interrupt (the virtual INTERRUPT key is pressed).

7.36.2 Syntax

Descriptive

EXT

Diagram

▶— EXT —————▶

7.36.3 Parameter

None.

7.36.4 Examples

Example 1:

Generate an external interrupt.

```
2007/06/30 15:30:01.015 00000FC4 ext
2007/06/30 15:30:01.015 00000FC4 HHCPN050I Interrupt key depressed
```

Figure 67: EXT command

7.37 F{+/-} (Mark frames usable or unusable)

7.37.1 Function

The F{+/-} command is used to mark storage frames as usable or unusable.

7.37.2 Syntax

Descriptive

F{+ | -} *addr*

Diagram

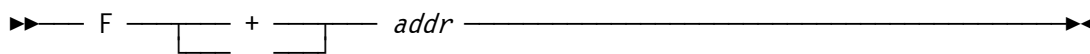

7.37.3 Parameter

- +** Mark storage frame as usable.
- Mark storage frame as unusable.
- addr** The address of the storage frame that has to be marked usable or unusable.

7.37.4 Examples

Example 1:

Mark frame at address x'01000000' as unusable.

```
2007/06/30 14:13:14.265 0000073C f- 01000000
2007/06/30 14:13:14.265 0000073C HHCPN131I Frame 01000000 marked unusable
```

Figure 68: F- command

Example 2:

Mark frame at address x'01000000' as usable.

```
2007/06/30 14:13:25.390 0000073C f+ 01000000  
2007/06/30 14:13:25.390 0000073C HHCPN131I Frame 01000000 marked usable
```

Figure 69: F+ command

7.38 FPC (Display floating point control register)

7.38.1 Function

The FPC command displays the content of the floating point control register.

7.38.2 Syntax



7.38.3 Parameter

None.

7.38.4 Examples

Example 1:

Display the floating point control register.

```
2007/06/30 12:14:14.968 00000FC4 fpc
2007/06/30 12:14:14.968 00000FC4 FPC=00000000
```

Figure 70: FPC command

7.39 FPR (Display floating point registers)

7.39.1 Function

The FPR command displays the actual contents of the floating point registers (basic format). If the AFP bit is set in CR0 then additional floating point registers are displayed (extended format).

7.39.2 Syntax

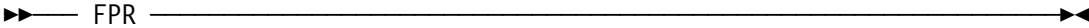
<p><u>Descriptive</u></p> <p>FPR</p> <p><u>Diagram</u></p> 

7.39.3 Parameter

None.

7.39.4 Examples

Example 1:

Display the floating point registers.

```
2007/08/25 18:07:09.263 00000E18 fpr
2007/08/25 18:07:09.263 00000E18 CPU0000: FPR0=00000000 00000000 FPR2=00000000 00000000
2007/08/25 18:07:09.263 00000E18 CPU0000: FPR4=00000000 00000000 FPR6=00000000 00000000
```

Figure 71: FPR command (basic format)

Example 2:

Display the floating point registers when the AFP bit is set in CR0.

```
2007/08/25 18:07:19.263 00000E18 fpr
2007/08/25 18:07:19.263 00000E18 CPU0000: FPR0=00000000 00000000 FPR2=00000000 00000000
2007/08/25 18:07:19.263 00000E18 CPU0000: FPR1=00000000 00000000 FPR3=00000000 00000000
2007/08/25 18:07:19.263 00000E18 CPU0000: FPR4=00000000 00000000 FPR6=00000000 00000000
2007/08/25 18:07:19.263 00000E18 CPU0000: FPR5=00000000 00000000 FPR7=00000000 00000000
2007/08/25 18:07:19.263 00000E18 CPU0000: FPR8=00000000 00000000 FP10=00000000 00000000
2007/08/25 18:07:19.263 00000E18 CPU0000: FPR9=00000000 00000000 FP11=00000000 00000000
2007/08/25 18:07:19.263 00000E18 CPU0000: FP12=00000000 00000000 FP14=00000000 00000000
2007/08/25 18:07:19.263 00000E18 CPU0000: FP13=00000000 00000000 FP15=00000000 00000000
```

Figure 72: FPR command (extended format)

7.40 G (Turn off instruction stepping and start CPU)

7.40.1 Function

The G command turns off the instruction stepping and starts the CPU. This command has also to be used to continue normal processing after stopping the instruction stepping with the S- command.

7.40.2 Syntax

<p><u>Descriptive</u></p> <p>G</p> <p><u>Diagram</u></p> <p>▶— G —▶</p>

7.40.3 Parameter

None.

7.40.4 Examples

Example 1:

Stop the instruction stepping and start the CPU.

```
13:52:59.375 00000FC4 g
13:52:59.375 00000FC4 HHCCP014I CPU0000: Special-operation exception CODE=0013 ILC=4
13:52:59.375 00000FC4 CPU0000: PSW=00080000 80000606 INST=B2790000 SACF 0(0)
13:52:59.375 00000FC4 CPU0000: R:00000000:K:06=00080000 800005EC 40404040 F0F04040 ..... 00
13:52:59.375 00000FC4 CPU0000: GR00=00000000 GR01=00000000 GR02=00000000 GR03=00000000
13:52:59.375 00000FC4 CPU0000: GR04=00000000 GR05=00000000 GR06=00000000 GR07=00000000
13:52:59.375 00000FC4 CPU0000: GR08=00000000 GR09=00000000 GR10=00000000 GR11=00000000
13:52:59.375 00000FC4 CPU0000: GR12=00000000 GR13=00000000 GR14=00000000 GR15=00000000
13:52:59.375 00000FC4 CPU0000: CR00=01B00200 CR01=00000000 CR02=00000000 CR03=00000000
13:52:59.375 00000FC4 CPU0000: CR04=00000000 CR05=00000000 CR06=FE000000 CR07=00000000
13:52:59.375 00000FC4 CPU0000: CR08=00000000 CR09=00000000 CR10=00000000 CR11=00000000
13:52:59.375 00000FC4 CPU0000: CR12=00000000 CR13=00000000 CR14=C2000000 CR15=00000000
13:52:59.390 00000FC4 HHCCD001I Readahead thread 1 started: tid=000000DC, pid=2068
13:52:59.390 00000FC4 HHCCD001I Readahead thread 2 started: tid=00000B6C, pid=2068
```

Figure 73: G command

7.41 GPR (Display or alter general purpose registers)

7.41.1 Function

The GPR command displays or alters the actual content of the general purpose registers.

7.41.2 Syntax

Descriptive

GPR [*nn=xxxxxxxx* | *nn=xxxxxxxxxxxxxxxxxxxx*]

Diagram

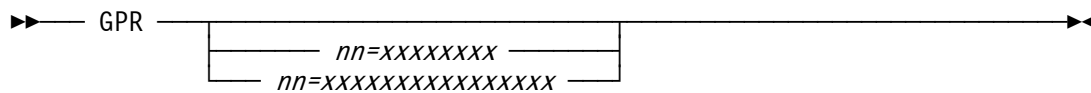

7.41.3 Parameter

- nn** This specifies the optional register number (00-15) to be altered.
- xxxxxxxx** This is the register value in hexadecimal (1-8 hex digits for 32-bit registers, 1-16 hex digits for 64-bit registers).

7.41.4 Examples

Example 1:

Display the general purpose registers.

```
16:54:31.625 00000FC4 gpr
16:54:31.625 00000FC4 CPU0000: GR00=00000000 GR01=00000000 GR02=0252E12C GR03=02501EB0
16:54:31.625 00000FC4 CPU0000: GR04=02502400 GR05=00000C00 GR06=01379E76 GR07=00000000
16:54:31.625 00000FC4 CPU0000: GR08=0248EF58 GR09=00000000 GR10=0252EF7F GR11=0252DF80
16:54:31.625 00000FC4 CPU0000: GR12=813799C8 GR13=0252DF80 GR14=81379D22 GR15=00000C00
```

Figure 74: GPR command (display general purpose registers)

Example 2:

Alter general purpose register number 15.

```
16:54:41.625 00000FC4 gpr 15=FF000000
16:54:41.625 00000FC4 CPU0000: GR00=00000000 GR01=00000000 GR02=0252E12C GR03=02501EB0
16:54:41.625 00000FC4 CPU0000: GR04=02502400 GR05=00000C00 GR06=01379E76 GR07=00000000
16:54:41.625 00000FC4 CPU0000: GR08=0248EF58 GR09=00000000 GR10=0252EF7F GR11=0252DF80
16:54:41.625 00000FC4 CPU0000: GR12=813799C8 GR13=0252DF80 GR14=81379D22 GR15=FF000000
```

Figure 75: GPR command (alter general purpose register)

7.42 HAO (Hercules Automatic Operator)

7.42.1 Function

The Hercules Automatic operator (HAO) feature is a facility that allows to automatically issue console commands in response to certain messages being issued. To use the HAO facility it is necessary to define a rule, consisting of a target and an associated command.

The Hercules Automatic Operator is only for those messages issued by Hercules to its console. It can not be used for messages issued from the guest operating system.

The current implementation limits the total number of defined rules to 10. There is currently no way to define a command whose arguments varies based on actual message text. All of the defined rules are checked for a match each time Hercules issues a message, there is no way at this time to stop the processing of subsequent rules.

7.42.2 Syntax

Descriptive

HAO TGT *target*

HAO CMD *command*

HAO LIST [*nn*]

HAO DEL *nn*

HAO CLEAR

Diagram

▶▶ HAO — TGT — *target* —————▶▶

▶▶ HAO — CMD — *command* —————▶▶

▶▶ HAO — LIST —————▶▶
 └── *nn* ───┘

▶▶ HAO — DEL — *nn* —————▶▶

▶▶ HAO — CLEAR —————▶▶

7.42.3 Parameter

TGT	Keyword to define a new rule (pattern).
target	Specifies the rule (pattern) to react on. The target is a regular expression pattern which is matched against the text of the messages that Hercules issues.
CMD	Keyword to specify a command for a previously defined rule.
command	Specifies the command to be executed if a target rule matches. The associated command must be a valid Hercules console command.
LIST	List all rules/commands or list only rule/command at index <i>nn</i> .
DEL	Delete rule and command at index <i>nn</i> .
nn	Number of the index to be listed or deleted.
CLEAR	Specifies to delete all defined rules. This stops the Automatic Operator.

7.42.4 Examples

Example 1:

Define target rule: Check for message HHCPN139E ("Command not found").

```
2007/06/20 16:54:31.625 00000FC4 hao tgt HHCPN139E
2007/06/20 16:54:31.625 00000FC4 HHCAO016I Target placed at index 0
```

Figure 76: HAO command (tgt).

Example 2:

Define command for target rule: Issue "?" command (List all valid commands).

```
2007/06/20 16:54:31.625 00000FC4 hao cmd ?
2007/06/20 16:54:31.625 00000FC4 HHCAO020I Command placed at index 0
```

Figure 77: HAO command (cmd)

Example 3:

List all defined rules.

```
2007/06/20 16:54:31.625 00000FC4 hao list
2007/06/20 16:54:31.625 00000FC4 HHCAO004I The defined Automatic Operator rule(s) are:
2007/06/20 16:54:31.625 00000FC4 HHCAO005I 00: 'HHCPN139E' -> '?'
2007/06/20 16:54:31.625 00000FC4 HHCAO006I 1 rule(s) displayed
```

Figure 78: HAO command (list)

Example 4:

Delete rule at index 0.

```
2007/06/20 16:54:31.625 00000FC4 hao del 0
2007/06/20 16:54:31.625 00000FC4 HHCAO025I Rule at index 0 succesfully deleted
```

Figure 79: HAO command (del)

Example 5:

Delete all rules (stop Hercules Automatic Operator).

```
2007/06/20 16:54:31.625 00000FC4 hao clear
2007/06/20 16:54:31.625 00000FC4 HHCAO022I All automatic operation rules cleared
```

Figure 80: HAO command (clear)

Example 6:

Sample of automatic execution of a command (triggerred via the use of an unknown console command, as defined in example 1 and 2).

```
2007/06/20 16:54:31.625 00000FC4 offload
2007/06/20 16:54:31.625 00000FC4 HHCPN139E Command "offload" not found; enter '?' for list.
2007/06/20 16:54:31.625 00000FC4 HHCAO003I Firing command '?'
2007/06/20 16:54:31.625 00000FC4 ?
2007/06/20 16:54:31.625 00000FC4 HHCPN140I Valid panel commands are...
2007/06/20 16:54:31.625 00000FC4
.
.
.
```

Figure 81: HAO fired command

7.43 HELP (List all commands / command specific help)

7.43.1 Function

The HELP command displays additional information for specific Hercules console commands if extra information is available. If the command has additional help text it will be displayed. HELP without parameter lists all available commands (see also "?" command). The help text is usually limited to explaining the format of the command and its various required or optional parameters and is not meant to replace reading the documentation.

7.43.2 Syntax

Descriptive

HELP [*command*]

Diagram

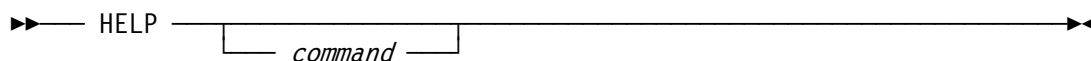

7.43.3 Parameter

command The Hercules console command to which additional information is desired.

7.43.4 Examples

Example 1:

Display help for a command with additional help information.

```
00000FC4 help ostailor
00000FC4 Format: "ostailor quiet | os/390 | z/os | vm | vse | linux | null". Specifies
00000FC4 the intended operating system. The effect is to reduce control panel message
00000FC4 traffic by selectively suppressing program check trace messages which are
00000FC4 considered normal in the specified environment. 'quiet' suppresses all
00000FC4 exception messages, whereas 'null' suppresses none of them. The other options
00000FC4 suppress some messages and not others depending on the specified o/s.
00000FC4 SEE ALSO the 'pgmtrace' command which allows you to further fine tune
00000FC4 the tracing of program interrupt exceptions.
```

Figure 82: HELP command (information available)

Example 2:

Display help for a command without additional help information.

```
2007/06/30 16:54:31.625 00000FC4 help quiet
2007/06/30 16:54:31.625 00000FC4 HHCPN142I No additional help available.
```

Figure 83: HELP command (no information available)

7.44 HERC (Send Hercules command)

7.44.1 Function

The HERC command sends a command in any CMDTGT mode to the Hercules Emulator. See also CMDTGT, SCP and PSCP commands.

7.44.2 Syntax

Descriptive

HERC [*cmd*]

Diagram

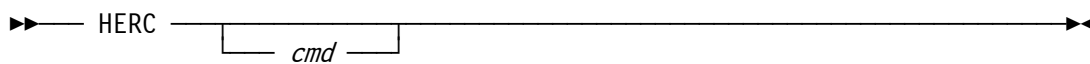

7.44.3 Parameter

cmd This is the command to be sent to the Hercules Emulator.

7.44.4 Examples

Example 1:

Send a Hercules command in SCP or PSCP command target mode..

```
2008/08/30 09:10:04.390 00000FC4 herc psw
2008/08/30 09:10:04.390 00000FC4 psw sm=00 pk=0 cmwp=0 as=pri cc=0 pm=0 am=24 ia=0
2008/08/30 09:10:04.390 00000FC4 PSW=00000000 00000000
```

Figure 84: HERC command

7.45 HERCLOGO (Read new logo file)

7.45.1 Function

The HERCLOGO command loads a new logo file for 3270 terminal sessions. For details on how to code the logo file see chapter 10.

7.45.2 Syntax

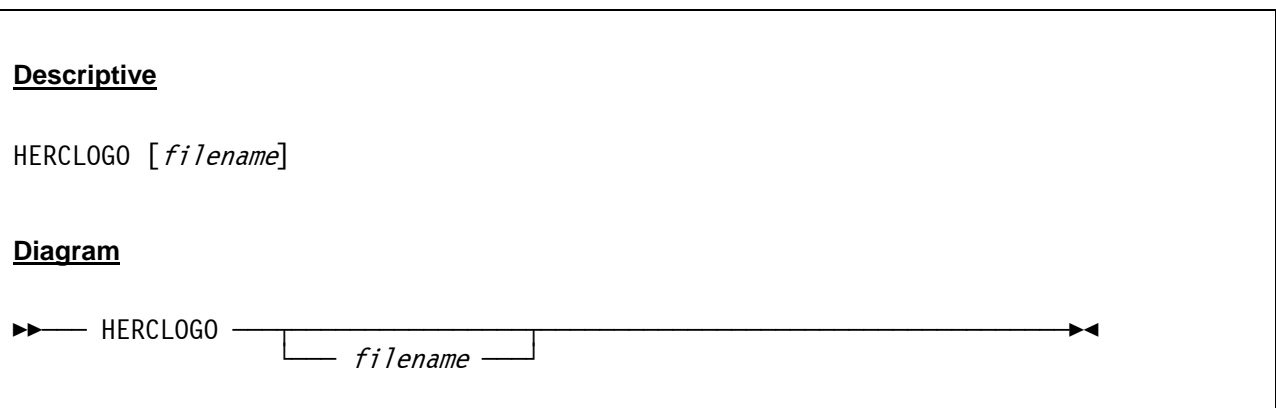

7.45.3 Parameter

filename The filename of a logo text file, located in the current Hercules directory, that will be loaded. If no filename is specified the built-in logo is used instead.

7.45.4 Examples

Example 1:

Load a new logo file.

```
2007/06/30 12:45:53.859 00000FC4 herclogo herclogo.txt
```

Figure 85: HERCLOGO command

7.46 HST (History of commands)

7.46.1 Function

The HST command displays a list of the last commands entered from the command line.

7.46.2 Syntax

Descriptive

HST [-1]

HST [-] *n*

HST {L | 0}

Diagram

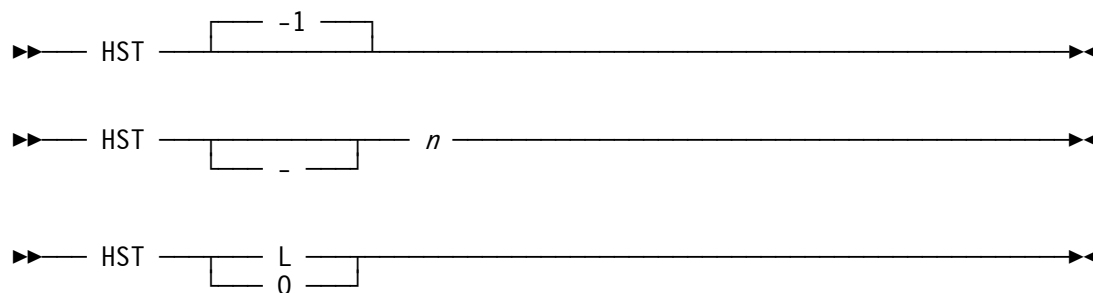

7.46.3 Parameter

- 1** HST -1 is the same as HST without argument and retrieves the last entered command.
- [-]n** If *n* is a positive number then HST retrieves the *n*-th command from the list. If *n* is a negative number then HST retrieves the *n*-th last command from the list.
- L or 0** HST L or HST 0 (number "0") displays a list of the last ten commands entered on the command line.

7.46.4 Examples

Example 1:

Display a list of the last ten commands entered.

```
2007/06/30 14:23:48.809 00000FC4 hst 0
2007/06/30 14:23:48.809 00000FC4 11 ipl 0A80
2007/06/30 14:23:48.809 00000FC4 12 ?
2007/06/30 14:23:48.809 00000FC4 13 aea
2007/06/30 14:23:48.809 00000FC4 14 aia
2007/06/30 14:23:48.809 00000FC4 15 ar
2007/06/30 14:23:48.809 00000FC4 16 clocks
2007/06/30 14:23:48.809 00000FC4 17 cr
2007/06/30 14:23:48.809 00000FC4 18 fpr
2007/06/30 14:23:48.809 00000FC4 19 gpr
2007/06/30 14:23:48.809 00000FC4 20 help maxrates
```

Figure 86: HST command

7.47 I (Generate I/O attention interrupt for device)

7.47.1 Function

The I command generates an I/O attention interrupt for a certain device.

7.47.2 Syntax

Descriptive

I *device*

Diagram

▶▶ — I — *device* —————▶▶

7.47.3 Parameter

device The number of the device for which an I/O attention interrupt will be generated.

7.47.4 Examples

Example 1:

Generate an I/O attention interrupt for device 0148.

```
2007/06/30 15:29:37.062 00000FC4 i 0148
2007/06/30 15:29:37.062 00000FC4 HHCPN045I Device 0148 attention request raised
```

Figure 87: I command

7.48 IODELAY (Display or set I/O delay value)

7.48.1 Function

The IODELAY command displays the current setting or sets the amount of time in microseconds to wait after an I/O interrupt is ready to be set pending. The purpose of this parameter is to bypass a bug in the Linux/390 and z/Linux dasd.c device driver. The problem is more apt to happen under Hercules than on a real machine, as Hercules may present an I/O interrupt sooner than a real machine.

7.48.2 Syntax

Descriptive

IODELAY [*usecs* [NOWARN]]

Diagram

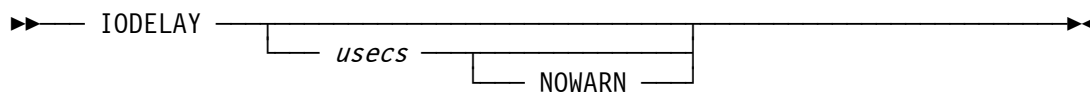

7.48.3 Parameter

- usecs** Amount of time in microseconds to wait after an I/O interrupt is ready to be set pending.
- NOWARN** If the IODELAY value is non-zero a warning message (HHCCF037W) will be issued unless NOWARN is specified.

7.48.4 Examples

Example 1:

Display the current IODELAY value.

```
2007/06/30 17:14:44.406 00000FC4 iodelay
2007/06/30 17:14:44.406 00000FC4 HHCPN030I I/O delay = 0
```

Figure 88: IODELAY command (display value)

Example 2:

Change the current IODELAY value.

```
2007/06/30 17:15:26.218 00000FC4 iodelay 50  
2007/06/30 17:15:26.218 00000FC4 HHCPN030I I/O delay = 50
```

Figure 89: IODELAY command (set value)

7.49 IPENDING (Display pending interrupts)

7.49.1 Function

The IPENDING command displays the pending interrupts for each CPU and some lock information.

7.49.2 Syntax

Descriptive

IPENDING

Diagram

▶— IPENDING —▶

7.49.3 Parameter

None

7.49.4 Examples

Example 1:

Display pending interrupts.

```
14:24:05.341 00000FC4 ipending
14:24:05.341 00000FC4 HHCPN123I CPU0000: CPUint=00000001 (State:00000001)&(Mask:DF00EE4F)
14:24:05.341 00000FC4 CPU0000: Interrupt not pending
14:24:05.341 00000FC4 CPU0000: I/O interrupt not pending
14:24:05.341 00000FC4 CPU0000: Clock comparator not pending
14:24:05.341 00000FC4 CPU0000: CPU timer not pending
14:24:05.341 00000FC4 CPU0000: Interval timer not pending
14:24:05.341 00000FC4 CPU0000: External call not pending
14:24:05.341 00000FC4 CPU0000: Emergency signal not pending
14:24:05.341 00000FC4 CPU0000: Machine check interrupt not pending
14:24:05.341 00000FC4 CPU0000: Service signal not pending
14:24:05.341 00000FC4 CPU0000: CPU interlock not held
14:24:05.341 00000FC4 CPU0000: lock not held
14:24:05.341 00000FC4 CPU0000: state STOPPED
14:24:05.341 00000FC4 CPU0000: instcount 2139645750
14:24:05.341 00000FC4 CPU0000: siocount 52968
14:24:05.341 00000FC4 CPU0000: psw 070e0000 00000000
14:24:05.341 00000FC4 HHCPN123I CPU0001: CPUint=00000001 (State:00000001)&(Mask:DF00EE4F)
14:24:05.341 00000FC4 CPU0001: Interrupt not pending
```

```

14:24:05.341 00000FC4 CPU0001: I/O interrupt not pending
14:24:05.341 00000FC4 CPU0001: Clock comparator not pending
14:24:05.341 00000FC4 CPU0001: CPU timer not pending
14:24:05.341 00000FC4 CPU0001: Interval timer not pending
14:24:05.341 00000FC4 CPU0001: External call not pending
14:24:05.341 00000FC4 CPU0001: Emergency signal not pending
14:24:05.341 00000FC4 CPU0001: Machine check interrupt not pending
14:24:05.341 00000FC4 CPU0001: Service signal not pending
14:24:05.341 00000FC4 CPU0001: CPU interlock not held
14:24:05.341 00000FC4 CPU0001: lock not held
14:24:05.341 00000FC4 CPU0001: state STOPPED
14:24:05.341 00000FC4 CPU0001: instcount 1263569267
14:24:05.341 00000FC4 CPU0001: siocount 20795
14:24:05.341 00000FC4 CPU0001: psw 070e0000 00000000
14:24:05.341 00000FC4 HHCPN123I CPU0002: offline
14:24:05.341 00000FC4 HHCPN123I CPU0003: offline
14:24:05.341 00000FC4 HHCPN123I CPU0004: offline
14:24:05.341 00000FC4 HHCPN123I CPU0005: offline
14:24:05.341 00000FC4 HHCPN123I CPU0006: offline
14:24:05.341 00000FC4 HHCPN123I CPU0007: offline
14:24:05.341 00000FC4 Config mask 00000003 started mask 00000003 waiting mask 00000003
14:24:05.341 00000FC4 Broadcast count 0 code 4
14:24:05.341 00000FC4 Signaling facility not busy
14:24:05.341 00000FC4 TOD lock not held
14:24:05.341 00000FC4 Main lock not held
14:24:05.341 00000FC4 Int lock not held
14:24:05.341 00000FC4 DEV0AE0: suspended
14:24:05.341 00000FC4 DEV0E21: busy local
14:24:05.341 00000FC4 I/O interrupt queue: (NULL)

```

Figure 90: IPENDING command

7.50 IPL (IPL normal from device xxxx)

7.50.1 Function

This console command performs the Initial Program Load (IPL) manual function from the given device. The IPL command may also be used to perform a load from CD-ROM or server. For example if a standard SUSE S/390 Linux distribution CD is loaded and mounted on /cdrom, this CD-ROM may then be IPL'ed using "IPL /cdrom/suse.ins".

If the first operand is a device name (devnum is a 1- to 4-digit hexadecimal number), a CCW-type IPL is initiated from the indicated device number and SCLP disk I/O is disabled.

If the first operand is a filename a list-directed IPL is performed from the specified ".ins" file and SCLP disk I/O is enabled for the directory path where the ".ins" file is located.

An optional 'PARM' keyword followed by a string can also be passed to the IPL command processor. The string will be loaded into the low-order 32 bits of the general purpose registers (4 characters per register for up to 64 bytes). The PARM option behaves similarly to the VM IPL command.

7.50.2 Syntax

Descriptive

IPL { *devnum* | *filename* } [PARM *string*]

Diagram

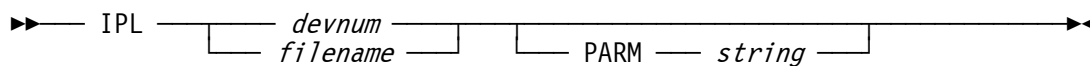

7.50.3 Parameter

- devnum** The device address from which the emulator will IPL the system.
- filename** The name of a ".ins" file to be loaded.
- PARM** Optional PARM keyword.
- string** The character string (max. 64 bytes) to be passed to the IPL command processor. The character string will be loaded into the low-order 32 bits of the GPRs (4 characters per register).

7.50.4 Examples

Example 1:

IPL normal from device 0148.

```
ipl 0148
HHCCP048I 0011:CCW=03000000 20000001=>040C0000 0001CEFA 00000000 00000000 .....
HHCCP075I 0011:Stat=0200 Count=0001
HHCCP076I 0011:Sense=40000000 00000000 00000000 00000000 00000000 00000000
HHCCP077I 0011:Sense=INTREQ
HHCCP048I 00C1:CCW=03000000 20000001=>040C0000 0001CEFA 00000000 00000000 .....
HHCCP075I 00C1:Stat=0200 Count=0001
HHCCP076I 00C1:Sense=40000000 00000000 00000000 00000000 00000000 00000000
HHCCP077I 00C1:Sense=INTREQ
HHCCP048I 00C2:CCW=03000000 20000001=>040C0000 0001CEFA 00000000 00000000 .....
HHCCP075I 00C2:Stat=0200 Count=0001
HHCCP076I 00C2:Sense=40000000 00000000 00000000 00000000 00000000 00000000
HHCCP077I 00C2:Sense=INTREQ
HHCCP075I 00C3:Stat=0200 Count=0001
HHCCP076I 00C3:Sense=40000000 00000000 00000000 00000000 00000000 00000000
HHCCP077I 00C3:Sense=INTREQ
HHCCP048I 00C4:CCW=03000000 20000001=>040C0000 0001CEFA 00000000 00000000 .....
HHCCP075I 00C4:Stat=0200 Count=0001
HHCCP076I 00C4:Sense=40000000 00000000 00000000 00000000 00000000 00000000
HHCCP077I 00C4:Sense=INTREQ
HHCCP048I 00C5:CCW=03000000 20000001=>040C0000 0001CEFA 00000000 00000000 .....
HHCCP075I 00C5:Stat=0200 Count=0001
HHCCP076I 00C5:Sense=40000000 00000000 00000000 00000000 00000000 00000000
HHCCP077I 00C5:Sense=INTREQ
HHCCP048I 00C6:CCW=03000000 20000001=>040C0000 0001CEFA 00000000 00000000 .....
HHCCP075I 00C6:Stat=0200 Count=0001
HHCCP076I 00C6:Sense=40000000 00000000 00000000 00000000 00000000 00000000
HHCCP077I 00C6:Sense=INTREQ
HHCCP048I 00C7:CCW=03000000 20000001=>040C0000 0001CEFA 00000000 00000000 .....
HHCCP075I 00C7:Stat=0200 Count=0001
HHCCP076I 00C7:Sense=40000000 00000000 00000000 00000000 00000000 00000000
HHCCP077I 00C7:Sense=INTREQ
HHCCP048I 0480:CCW=03000000 20000001=>040C0000 0001CEFA 00000000 00000000 .....
HHCCP075I 0480:Stat=0200 Count=0001
HHCCP076I 0480:Sense=40220000 00C00300 00000000 00800100 010000FF FF000000
HHCCP077I 0480:Sense=INTREQ EOC WRI
.
.
.
```

Figure 91: IPL command

7.51 IPLC (IPL clear from device xxxx)

7.51.1 Function

This console command performs the Initial Program Load (IPL) clear manual function from the given device. The IPL command may also be used to perform a load from CD-ROM or server. For example if a standard SUSE S/390 Linux distribution CD is loaded and mounted on /cdrom, this CD-ROM may then be IPL'ed using "IPL /cdrom/suse.ins".

If the first operand is a device name (devnum is a 1- to 4-digit hexadecimal number), a CCW-type IPL is initiated from the indicated device number and SCLP disk I/O is disabled.

If the first operand is a filename a list-directed IPL is performed from the specified ".ins" file and SCLP disk I/O is enabled for the directory path where the ".ins" file is located.

An optional 'PARM' keyword followed by a string can also be passed to the IPL command processor. The string will be loaded into the low-order 32 bits of the general purpose registers (4 characters per register for up to 64 bytes). The PARM option behaves similarly to the VM IPL command.

7.51.2 Syntax

Descriptive

```
IPLC { devnum | filename } [PARM string]
```

Diagram

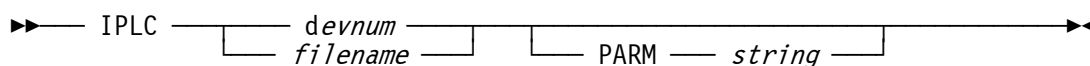

7.51.3 Parameter

- | | |
|-----------------|---|
| devnum | The device address from which the emulator will IPL the system. |
| filename | The name of a ".ins" file to be loaded. |
| PARM | Optional PARM keyword. |
| string | The character string (max. 64 bytes) to be passed to the IPL command processor. The character string will be loaded into the low-order 32 bits of the GPRs (4 characters per register). |

7.51.4 Examples

Example 1:

IPL clear from device 0148.

```
iplc 0148
HHCCP048I 0011:CCW=03000000 20000001=>040C0000 0001CEFA 00000000 00000000 .....
HHCCP075I 0011:Stat=0200 Count=0001
HHCCP076I 0011:Sense=40000000 00000000 00000000 00000000 00000000 00000000
HHCCP077I 0011:Sense=INTREQ
HHCCP048I 00C1:CCW=03000000 20000001=>040C0000 0001CEFA 00000000 00000000 .....
HHCCP075I 00C1:Stat=0200 Count=0001
HHCCP076I 00C1:Sense=40000000 00000000 00000000 00000000 00000000 00000000
HHCCP077I 00C1:Sense=INTREQ
HHCCP048I 00C2:CCW=03000000 20000001=>040C0000 0001CEFA 00000000 00000000 .....
HHCCP075I 00C2:Stat=0200 Count=0001
HHCCP076I 00C2:Sense=40000000 00000000 00000000 00000000 00000000 00000000
HHCCP077I 00C2:Sense=INTREQ
HHCCP075I 00C3:Stat=0200 Count=0001
HHCCP076I 00C3:Sense=40000000 00000000 00000000 00000000 00000000 00000000
HHCCP077I 00C3:Sense=INTREQ
HHCCP048I 00C4:CCW=03000000 20000001=>040C0000 0001CEFA 00000000 00000000 .....
HHCCP075I 00C4:Stat=0200 Count=0001
HHCCP076I 00C4:Sense=40000000 00000000 00000000 00000000 00000000 00000000
HHCCP077I 00C4:Sense=INTREQ
HHCCP048I 00C5:CCW=03000000 20000001=>040C0000 0001CEFA 00000000 00000000 .....
HHCCP075I 00C5:Stat=0200 Count=0001
HHCCP076I 00C5:Sense=40000000 00000000 00000000 00000000 00000000 00000000
HHCCP077I 00C5:Sense=INTREQ
HHCCP048I 00C6:CCW=03000000 20000001=>040C0000 0001CEFA 00000000 00000000 .....
HHCCP075I 00C6:Stat=0200 Count=0001
HHCCP076I 00C6:Sense=40000000 00000000 00000000 00000000 00000000 00000000
HHCCP077I 00C6:Sense=INTREQ
HHCCP048I 00C7:CCW=03000000 20000001=>040C0000 0001CEFA 00000000 00000000 .....
HHCCP075I 00C7:Stat=0200 Count=0001
HHCCP076I 00C7:Sense=40000000 00000000 00000000 00000000 00000000 00000000
HHCCP077I 00C7:Sense=INTREQ
HHCCP048I 0480:CCW=03000000 20000001=>040C0000 0001CEFA 00000000 00000000 .....
HHCCP075I 0480:Stat=0200 Count=0001
HHCCP076I 0480:Sense=40220000 00C00300 00000000 00800100 010000FF FF000000
HHCCP077I 0480:Sense=INTREQ EOC WRI
.
.
.
```

Figure 92: IPLC command

7.52 K (Display CCKD internal trace)

7.52.1 Function

The K command displays the internal CCKD trace entries. Because the default value for the CCKD trace entries is set to zero, the trace must first be enabled by setting a trace entry value. This can be done either with the system parameter or the console command "CCKD TRACE=n", where n specifies the number of available trace entries and can be in the range of 1 to 200000.

Please note that the K command can produce a lot of messages depending on the available trace entries.

7.52.2 Syntax

Descriptive

K

Diagram

▶▶ — K ————— ▶▶

7.52.3 Parameter

None.

7.52.4 Examples

Example 1:

Display the current CCKD trace entries.

```
0000008E k
0000008E HHCCD900I print_itrace
0000008E 14:31:27.109347 0148:gcperc size 262144 lst 0xfb72c45 nbr 69 largest 16099545
0000008E 14:31:27.109371 0148:gcperc free[ 0]:0fb72c45 end 0fb72cbe len 121*pend 0
0000008E 14:31:27.109382 0148:gcperc free[ 67]:0fb72cbe end 0fb7ea56 len 48536 pend 1
0000008E 14:31:27.109392 0148:gcperc free[ 1]:0fba543c end 0fba5f64 len 2856 pend 0
0000008E 14:31:27.109403 0148:gcperc free[ 2]:0fba6094 end 0fba60bb len 39 pend 0
0000008E 14:31:27.109413 0148:gcperc free[ 3]:0fbb7989 end 0fbb7a1b len 146 pend 0
0000008E 14:31:27.109421 0148:gcperc free[ 4]:0fbb7ab4 end 0fbb7b26 len 114 pend 0
0000008E 14:31:27.109428 0148:gcperc free[ 5]:0fbc971a end 0fbc975b len 65 pend 0
.
several lines not displayed
.
0000008E 14:31:27.109844 0148:gcperc selected space 0xfb7ea56 len 65778
```

```

0000008E 14:31:27.109850 0148:file[0] fd[5] read, off 0xfb7ea56 len 65778
0000008E 14:31:27.109942 0148:file[0] l2[99,111] trk[25455] read_l2ent 0x31f10
0000008E 14:31:27.109950 0148:file[0] read_l2 99 active 0 0 0
0000008E 14:31:27.109956 0148:l2[0,99] cache[82] hit
0000008E 14:31:27.109961 0148:file[0] l2[99,111] trk[25455] read_l2ent 0xfb7ea56 22094 22094
0000008E 14:31:27.109968 0148:gcperc move trk 25455 at pos 0xfb7ea56 len 22094
0000008E 14:31:27.109973 0148:file[0] trk[25455] write_trkimg len 22094 buf 08B0FF28:0106a10000
0000008E 14:31:27.109981 0148:file[0] read_l2 99 active 0 99 82
0000008E 14:31:27.109986 0148:file[0] trk[25455] write_trkimg oldl2 0xfb7ea56 22094 22094
0000008E 14:31:27.110006 0148:get_space len 22094 largest 16099545 flags 0x01
0000008E 14:31:27.110012 0148:get_space found 0x10f9c970 len 22094 size 22094
0000008E 14:31:27.110018 0148:file[0] fd[5] write, off 0x10f9c970 len 22094
0000008E 14:31:27.120709 0148:file[0] l2[99,111] trk[25455] write_l2ent 0x10f9c970 22094 22094
0000008E 14:31:27.120719 0148:file[0] fd[5] write, off 0x32288 len 8
0000008E 14:31:27.120734 0148:rel_space offset fb7ea56 len 22094 size 22094
0000008E 14:31:27.120743 0148:file[0] l2[127,0] trk[32512] read_l2ent 0x3ff10
0000008E 14:31:27.120749 0148:file[0] read_l2 127 active 0 99 82
0000008E 14:31:27.120755 0148:l2[0,127] cache[110] hit
0000008E 14:31:27.120759 0148:file[0] l2[127,0] trk[32512] read_l2ent 0xfb840a4 372 372
0000008E 14:31:27.120766 0148:gcperc move trk 32512 at pos 0xfb840a4 len 372
0000008E 14:31:27.120771 0148:file[0] trk[32512] write_trkimg len 372 buf 08B15576:0108770007
0000008E 14:31:27.120778 0148:file[0] read_l2 127 active 0 127 110
0000008E 14:31:27.120783 0148:file[0] trk[32512] write_trkimg oldl2 0xfb840a4 372 372
0000008E 14:31:27.120789 0148:get_space len 372 largest 16077451 flags 0x01
0000008E 14:31:27.120794 0148:get_space found 0xfba543c len 372 size 372
0000008E 14:31:27.120799 0148:file[0] fd[5] write, off 0xfba543c len 372
0000008E 14:31:27.120814 0148:file[0] l2[127,0] trk[32512] write_l2ent 0xfba543c 372 372
0000008E 14:31:27.120822 0148:file[0] fd[5] write, off 0x3ff10 len 8
0000008E 14:31:27.120837 0148:rel_space offset fb840a4 len 372 size 372
0000008E 14:31:27.120845 0148:file[0] l2[126,232] trk[32488] read_l2ent 0x3f710
0000008E 14:31:27.120852 0148:file[0] read_l2 126 active 0 127 110
0000008E 14:31:27.120857 0148:l2[0,126] cache[109] hit
0000008E 14:31:27.120862 0148:file[0] l2[126,232] trk[32488] read_l2ent 0xfb84218 373 373
0000008E 14:31:27.120869 0148:gcperc move trk 32488 at pos 0xfb84218 len 373
0000008E 14:31:27.120874 0148:file[0] trk[32488] write_trkimg len 373 buf 08B156EA:010875000d
0000008E 14:31:27.120881 0148:file[0] read_l2 126 active 0 126 109
0000008E 14:31:27.120886 0148:file[0] trk[32488] write_trkimg oldl2 0xfb84218 373 373
0000008E 14:31:27.120892 0148:get_space len 373 largest 16077451 flags 0x01
0000008E 14:31:27.120897 0148:get_space found 0xfba55b0 len 373 size 373
0000008E 14:31:27.120902 0148:file[0] fd[5] write, off 0xfba55b0 len 373
0000008E 14:31:27.120914 0148:file[0] l2[126,232] trk[32488] write_l2ent 0xfba55b0 373 373
0000008E 14:31:27.120922 0148:file[0] fd[5] write, off 0x3fe50 len 8
0000008E 14:31:27.120934 0148:rel_space offset fb84218 len 373 size 373
.
.
.

```

Figure 93: K command

7.53 LDMOD (Load a module)

7.53.1 Function

The LDMOD command loads a module.

7.53.2 Syntax

Descriptive

LDMOD *module*

Diagram

▶— LDMOD — *module* —————▶

7.53.3 Parameter

module The name of the module that has to be loaded.

7.53.4 Examples

Example 1:

Load module “dyncrypt”.

```
10:33:50.078 0000008E ldmod dyncrypt
10:33:50.078 0000008E HHCHD100I Loading dyncrypt ...
10:33:50.093 0000008E Crypto module loaded (c) Copyright Bernard van der Helm, 2003-2005
10:33:50.093 0000008E HHCHD101I Module dyncrypt loaded
```

Figure 94: LDMOD command

7.54 LOADCORE (Load a core image file)

7.54.1 Function

The LOADCORE command allows you to load a binary data file into real storage. This function is used mainly for emulator debugging purposes. A certain core snapshot that was saved can be restored at any later time to reproduce some tests with identical real storage values. The file *filename* is presumed to be a pure binary image file previously created via the SAVECORE command.

Please note that you must stop all CPUs (see STOP / STOPALL commands) before loading a core image from a file.

7.54.2 Syntax

Descriptive

LOADCORE *filename* [*address* | 0]

Diagram

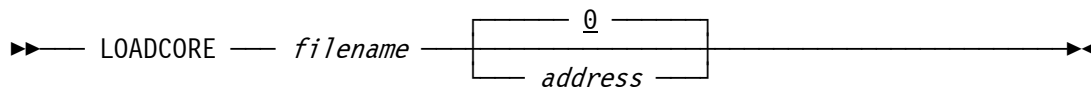

7.54.3 Parameter

filename This argument specifies the file name (and optionally the path) of the file from which the core image will be loaded.

address Address specifies the start address of the real storage to where the saved file has to be loaded to. A value of zero, the default, means the beginning of real storage.

7.54.4 Examples

Example 1:

Load a core image file to address zero of real storage.

```
2007/06/30 09:52:20.203 0000008E stopall
2007/06/30 09:52:25.781 0000008E loadcore d:\core02.bin 0
2007/06/30 09:52:25.812 0000008E HHCPN112I Loading d:\core02.bin to location 0
2007/06/30 09:52:34.171 0000008E HHCPN113I 268431360 bytes read from d:\core02.bin
```

Figure 95: LOADCORE command

7.55 LOADPARM (Set IPL parameter)

7.55.1 Function

The LOADPARM command displays or changes the eight-character IPL parameter which is used by all MVS based operating systems (MVS 3.8J, MVS/SP, MVS/XA, MVS/ESA, OS/390, z/OS, ...) to select the system parameter.

7.55.2 Syntax

Descriptive

LOADPARM [*ipl_parameter*]

Diagram

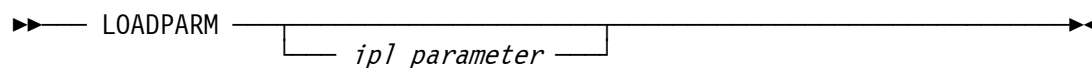

7.55.3 Parameter

ipl_parameter The system parameter used for the IPL of the intended operating system. The parameters are operating system dependent, the manuals of the operating system must be consulted for details.

7.55.4 Examples

Example 1:

Display the current LOADPARM setting.

```
2007/06/30 08:15:03.875 00000FC4 loadparm
2007/06/30 08:15:03.875 00000FC4 HHCPN051I LOADPARM=014800M1
```

Figure 96: LOADPARM command (display IPL parameter)

Example 2:

Change the current LOADPARM setting.

```
2007/06/30 08:15:19.109 00000FC4 loadparm 014800t1  
2007/06/30 08:15:19.109 00000FC4 HHCPN051I LOADPARM=014800T1
```

Figure 97: LOADPARM command (set IPL parameter)

7.56 LOADTEXT (Load a text deck file)

7.56.1 Function

The LOADTEXT command is essentially identical to the LOADCORE command (see section 7.54 for details) except that it loads a text deck file with “TXT” and “END” 80 byte records (i.e. an object deck).

7.56.2 Syntax



7.56.3 Parameter

- filename** This argument specifies the file name (and optionally the path) of the file from which the text deck will be loaded.
- address** Address specifies the start address of the real storage to where the saved text deck file will be loaded.

7.56.4 Examples

See LOADCORE command for similar examples.

7.57 LOG (Direct log output)

7.57.1 Function

The LOG command lets you redirect the log output to another destination.

7.57.2 Syntax

Descriptive

LOG *newfile*

Diagram

▶— LOG — *newfile* —————▶

7.57.3 Parameter

newfile The file name and optionally the path to which the log output has to be written to.

7.57.4 Examples

Example 1:

Redirect the log output to a new log file destination.

```
2007/06/30 15:53:03.343 0000008E log d:/mvs/log/newlog.txt
2007/06/30 15:53:03.343 0000008E HHCLG018I log switched to d:/mvs/log/newlog.txt
```

Figure 98: LOG command

7.58 LOGOPT (Change log options)

7.58.1 Function

The LOGOPT command lets you change the logging options. "TIMESTAMP" inserts a time stamp in front of each log message, whereas "NOTIMESTAMP" displays log messages with no time stamps. Entering the command without any argument displays the current logging options.

7.58.2 Syntax

Descriptive

LOGOPT [TIMESTAMP | NOTIMESTAMP | TIME | NOTIME]

Diagram

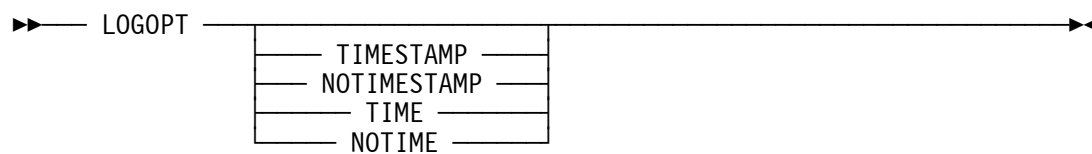

7.58.3 Parameter

TIMESTAMP	Insert a time stamp in front of each log message. This is the same as using TIME.
NOTIMESTAMP	Display log messages without a timestamp. This is the same as using NOTIME.
TIME	Insert a time stamp in front of each log message. This is the same as using TIMESTAMP.
NOTIME	Display log messages without a timestamp. This is the same as using NOTIMESTAMP.

7.58.4 Examples

Example 1:

Insert a time stamp in front of each log message.

```
2007/06/30 17:34:47.843 0000008E logopt timestamp
2007/06/30 17:34:47.843 0000008E HHCPN197I Log option set: TIMESTAMP
```

Figure 99: LOGOPT command

7.59 LPARNAME (Display or set LPAR name)

7.59.1 Function

The LPARNAME command is used to display the current LPAR name or to define the LPAR name returned by the DIAG x'204'.

7.59.2 Syntax

Descriptive

LPARNAME [*lparname*]

Diagram

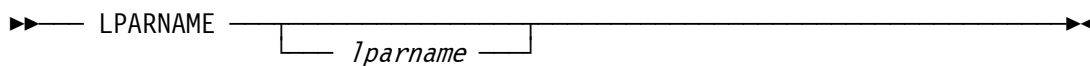

7.59.3 Parameter

lparname This specifies the new LPAR name. The value must be maximum 8 alphanumeric characters. If this parameter is omitted the current LPAR name is displayed.

7.59.4 Examples

Example 1:

Display the current LPAR name.

```
2009/01/15 05:58:16.781 00000FE4 lparname
2009/01/15 05:58:16.781 00000FE4 HHCPN056I LPAR name = HERCULES
```

Figure 100: LPARNAME command (display LPAR name)

Example 2:

Define a new LPAR name.

```
2009/01/15 05:59:24.212 00000FE4 lparname TESTLPAR
2009/01/15 05:59:24.212 00000FE4 lparname
2009/01/15 05:59:24.212 00000FE4 HHCPN056I LPAR name = TESTLPAR
```

Figure 101: LPARNAME command (define LPAR name)

7.60 LPARNUM (Display or set LPAR identification number)

7.60.1 Function

The LPARNUM console command displays or set the LPAR identification number. The LPAR identification number can be one or two hexadecimal digits. If one digit is specified then STIDP stores a format-0 CPU ID containing the logical CPU number, the LPAR number, and the last four digits of the CPU serial number. If two digits are specified then STIDP stores a format-1 CPU ID containing the two-digit LPAR identifier followed by the last four digits of the CPU serial number..

7.60.2 Syntax



7.60.3 Parameter

xx Specifies the one- or two-digit hexadecimal LPAR identification number stored by the STIDP instruction. If a one-digit number is specified then STIDP stores a format-0 CPU ID. If a two-digit number is specified then STIDP stores a format-1 CPU-ID..

7.60.4 Examples

Example 1:

Set LPARNUM to 21.

```
2009/03/31 23:34:30.402 00000708 lparnum 21
```

Figure 102: LPARNUM command (set LPARNUM).

Example 2:

Display LPARNUM.

```
2009/03/31 23:34:33.402 00000708 lparnum  
2009/03/31 23:34:33.402 00000708 HHCPN060I LPAR number = 21
```

Figure 103: LPARNUM command (display LPARNUM).

7.61 LSDEP (List module dependencies)

7.61.1 Function

This function lists the Hercules module dependencies.

7.61.2 Syntax

Descriptive

LSDEP

Diagram

▶— LSDEP —————▶

7.61.3 Parameter

None.

7.61.4 Examples

Example 1:

List the module dependencies.

```
2007/06/30 14:24:39.637 00000FC4 lsdep
2007/06/30 14:24:39.637 00000FC4 dependency(HERCULES) version(3.03) size(5)
2007/06/30 14:24:39.637 00000FC4 dependency(REGS) version(3.03) size(38376)
2007/06/30 14:24:39.637 00000FC4 dependency(DEVBLK) version(3.03) size(1664)
2007/06/30 14:24:39.637 00000FC4 dependency(SYSBLK) version(3.03) size(39440)
2007/06/30 14:24:39.637 00000FC4 dependency(WEBBLK) version(2.17) size(24)
```

Figure 104: LSDEP command

7.62 LSMOD (List dynamic modules)

7.62.1 Function

The LSMOD command lists all the loaded Hercules dynamic modules and shows details for each module.

7.62.2 Syntax

Descriptive

LSMOD

Diagram

▶— LSMOD —————▶

7.62.3 Parameter

None.

7.62.4 Examples

Example 1:

List the dynamic modules.

```
00000FC4 lsmod
00000FC4 dll type = load, name = hdt3088
00000FC4 symbol = debug_tt32_stats, loadcount = 1, owner = hdt3088
00000FC4 devtype = CTCT-W32 VMNET CTCT CTCT 3088 LCS
00000FC4 dll type = load, name = hdt3420
00000FC4 devtype = 3430 3422 8809 9348 9347 3490 3480 3420 3411 3410
00000FC4 dll type = load, name = hdt3270
00000FC4 devtype = 3287 3270 3215 1052
00000FC4 dll type = load, name = hdt1403
00000FC4 devtype = 3211 1403
00000FC4 dll type = load, name = hdt3525
00000FC4 devtype = 3525
00000FC4 dll type = load, name = hdt3505
00000FC4 devtype = 3505 2501 1442
00000FC4 dll type = load, name = dyngui
00000FC4 symbol = panel_command, loadcount = 2, owner = dyngui
00000FC4 symbol = debug_cpu_state, loadcount = 1, owner = dyngui
00000FC4 symbol = daemon_task, loadcount = 1, owner = dyngui
00000FC4 symbol = panel_display, loadcount = 1, owner = dyngui
```



```

00000FC4 dll type = load, name = dyncrypt
00000FC4 symbol = z900_compute_message_authentication_code, loadcount = 1, owner = dyncrypt
00000FC4 symbol = z900_compute_last_message_digest, loadcount = 1, owner = dyncrypt
00000FC4 symbol = z900_compute_intermediate_message_digest, loadcount = 1, owner = dyncrypt
00000FC4 symbol = z900_cipher_message_with_chaining, loadcount = 1, owner = dyncrypt
00000FC4 symbol = z900_cipher_message, loadcount = 1, owner = dyncrypt
00000FC4 symbol = s390_compute_message_authentication_code, loadcount = 1, owner = dyncrypt
00000FC4 symbol = s390_compute_last_message_digest, loadcount = 1, owner = dyncrypt
00000FC4 symbol = s390_compute_intermediate_message_digest, loadcount = 1, owner = dyncrypt
00000FC4 symbol = s390_cipher_message_with_chaining, loadcount = 1, owner = dyncrypt
00000FC4 symbol = s390_cipher_message, loadcount = 1, owner = dyncrypt
00000FC4 dll type = load, name = hdteq
00000FC4 symbol = hdl_device_type_equates, loadcount = 1, owner = hdteq
00000FC4 dll type = main, name = *Hercules, flags = (nounload)
00000FC4 symbol = panel_display, loadcount = 0, owner = *Hercules
00000FC4 symbol = panel_command, loadcount = 0, owner = *Hercules
00000FC4 symbol = parse_args, loadcount = 0, owner = *Hercules
00000FC4 devtype = 9336 9335 9332 9313 3370 3310 0671 9345 3390 3380 3375 3350 3340 3330 2314
                2311

```

Figure 105: LSMOD command

7.63 MAXRATES (Display maximum observed MIPS/SIO rate or define new reporting interval)

7.63.1 Function

The MAXRATES command shows the maximum observed MIPS (million instructions per second) and SIO (Start I/O) rates reached during the current interval. It lets you also set the MAXRATES interval to another value than the default of 1440 minutes (1 day).

7.63.2 Syntax

Descriptive

MAXRATES [*interval*]

Diagram

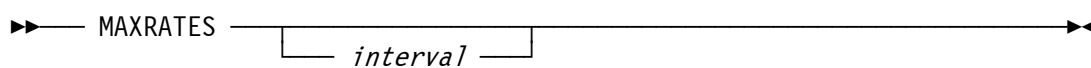

7.63.3 Parameter

interval The new interval time in minutes. The default value is 1440 minutes (1 day).

7.63.4 Examples

Example 1:

Change the MAXRATES interval from the default value (or the last manually set interval value) to 60 minutes.

```
2007/06/30 14:24:59.343 00000FC4 maxrates 60
2007/06/30 14:24:59.343 00000FC4 Maxrates interval set to 60 minutes.
```

Figure 106: MAXRATES command (set the interval time)

Example 2:

Display the maximum observed MIPS and I/O rates during the last interval.

```
2007/06/30 14:24:54.262 00000FC4 maxrates
2007/06/30 14:24:54.262 00000FC4 Highest observed MIPS/SIOS rates:
2007/06/30 14:24:54.262 00000FC4
2007/06/30 14:24:54.262 00000FC4 From: Wed Sep 20 14:13:20 2005
2007/06/30 14:24:54.262 00000FC4 To: Wed Sep 20 14:13:20 2005
2007/06/30 14:24:54.262 00000FC4
2007/06/30 14:24:54.262 00000FC4 MIPS: 0.00
2007/06/30 14:24:54.262 00000FC4 SIOS: 0
2007/06/30 14:24:54.262 00000FC4
2007/06/30 14:24:54.262 00000FC4 From: Wed Sep 20 14:13:20 2005
2007/06/30 14:24:54.262 00000FC4 To: Wed Sep 20 14:24:54 2005
2007/06/30 14:24:54.262 00000FC4
2007/06/30 14:24:54.262 00000FC4 MIPS: 397.425046
2007/06/30 14:24:54.262 00000FC4 SIOS: 5441
2007/06/30 14:24:54.262 00000FC4
2007/06/30 14:24:54.262 00000FC4 Current interval = 1440 minutes.
```

Figure 107: MAXRATES command (display maximum rates)

7.64 MESSAGE (Display message on console like VM)

7.64.1 Function

The MESSAGE command is actually a VM CP command. It is used to transmit message text to the virtual console of other active users.

However, some programmers also use this command as a simplified way to display messages on the own virtual machine console by using "MESSAGE * <message text>". One program that uses this is the IBM "System z" port of Solaris which is only capable of running under z/VM.

So basically, all the MESSAGE command does is to display a message on the Hercules console with VM like headers. Therefore the MESSAGE command is not really intended to be used directly from the Hercules console as shown in the example below, although it does not hurt doing so.

MSG is the same as MESSAGE. See also the MSG and MSGNOH commands in this manual.

7.64.2 Syntax

Descriptive

MESSAGE *parms*

Diagram

▶— MESSAGE — *parms* —▶

7.64.3 Parameter

parms *parms* specifies the required and optional parameters as described in IBM's VM "CP Commands and Utilities Reference" manual.

7.64.4 Examples

Example 1:

Display a message on the own virtual machine console.

```
18:23:58 message * transmitted message to VM console
18:23:58 18:23:58 * MSG FROM HERCULES: transmitted message to VM console
```

Figure 108: MESSAGE command

7.65 MOUNTED_TAPE_REINIT (Control tape initialization)

7.65.1 Function

The MOUNTED_TAPE_REINIT command controls whether reinitialization of tape drive devices via the DEVINIT command in order to mount a new tape should be allowed if there is already a tape mounted on the drive. Without a parameter given the current setting is displayed.

Specifying ALLOW indicates that new tapes may be mounted via "DEVINIT nnnn new-tape-filename" irrespective of whether or not there is already a tape mounted on the drive.

Specifying DISALLOW prevents new tapes from being mounted if one is already mounted. Before the new tape can be mounted the existing one has first to be unmounted (via the "DEVINIT nnnn *" command). Otherwise the DEVINIT attempt to mount the new tape is rejected.

This option is meant as a safety mechanism to protect against accidentally unmounting a tape from the wrong device as a result of a simple typing error and thereby eventually cancelling a potentially important tape job.

Please note that for SCSI tape drives the "DEVINIT nnnn *" command has no effect. The tape must be unmounted manually since it is a real physical device and not emulated via a disk file like '.AWS' or '.HET' tapes.

7.65.2 Syntax

Descriptive

```
MOUNTED_TAPE_REINIT [ALLOW | DISALLOW]
```

Diagram

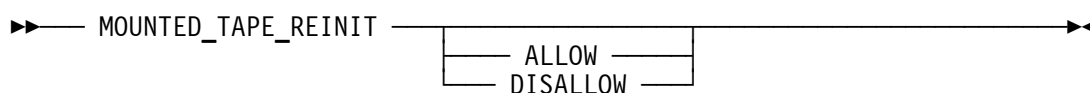

7.65.3 Parameter

ALLOW Indicates that new tapes may be mounted irrespective of whether or not there is already a tape mounted on the drive. This is the default.

DISALLOW Prevents new tapes from being mounted if one is already mounted on the drive. Before the new tape can be mounted the currently mounted tape must first to be unmounted.

7.65.4 Examples

Example 1:

Display current tape mount settings.

```
2009/03/07 22:20:01.328 00000D44 mounted_tape_reinit
2009/03/07 22:20:01.328 00000D44 Tape mount reinit allowed
```

Figure 109: MOUNTED_TAPE_REINIT command (display settings).

Example 2:

Disallow tape mount reinitialization.

```
2009/03/07 22:20:14.718 00000D44 mounted_tape_reinit disallow
2009/03/07 22:20:17.968 00000D44 mounted_tape_reinit
2009/03/07 22:20:17.968 00000D44 Tape mount reinit disallowed
```

Figure 110: MOUNTED_TAPE_REINIT command (disallow tape mount reinitialization)

7.66 MSG (Display message on console like VM)

7.66.1 Function

The MSG command is actually a VM CP command. It is used to transmit message text to the virtual console of other active users.

However, some programmers also use this command as a simplified way to display messages on the own virtual machine console by using "MSG * <message text>". One program that uses this is the IBM "System z" port of Solaris which is only capable of running under z/VM.

So basically, all the MSG command does is to display a message on the Hercules console with VM like headers. Therefore the MSG command is not really intended to be used directly from the Hercules console as shown in the example below, although it does not hurt doing so.

MESSAGE is the same as MSG. See also the MESSAGE and MSGNOH commands in this manual.

7.66.2 Syntax

Descriptive

MSG *parms*

Diagram

▶— MSG — *parms* —▶

7.66.3 Parameter

parms *parms* specifies the required and optional parameters as described in IBM's VM "CP Commands and Utilities Reference" manual.

7.66.4 Examples

Example 1:

Display a message on the own virtual machine console.

```
18:24:09 msg * transmitted message to VM console
18:24:09 18:24:09 * MSG FROM HERCULES: transmitted message to VM console
```

Figure 111: MSG command

7.67 MSGHLD (Display or set timeout of held messages)

7.67.1 Function

The MSGHLD console command is used to display or set the timeout value of held messages. It is also possible to release all held messages without having to wait for the timeout period to expire.

7.67.2 Syntax

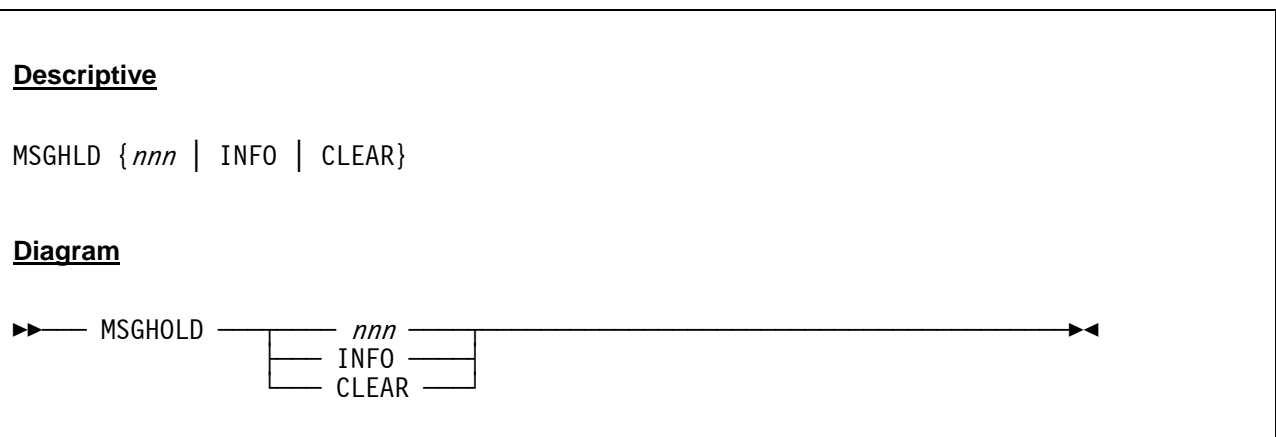

7.67.3 Parameter

- nnn** This value specifies the new timeout value of held messages in seconds.
- INFO** Display the current message held time setting.
- CLEAR** Release the held messages immediately.

7.67.4 Examples

Example 1:

Set the new timeout interval for held messages to 30 seconds.

```
2009/01/08 09:09:34.781 00000CA0 msghld 30
2009/01/08 09:09:34.781 00000CA0 Current message held time is set to 30 seconds.
```

Figure 112: MSGHELD command (set new interval)

Example 2:

Release all held messages.

```
2009/01/08 09:10:38.241 00000CA0 msghld clear  
2009/01/08 09:10:38.241 00000CA0 Held messages cleared
```

Figure 113: MSGHELD command (release messages)

7.68 MSGNOH (Display message on console like VM, but without header)

7.68.1 Function

The MSGNOH command is actually a VM CP command. It is used to transmit message text to the virtual console of other active users without the standard MESSAGE command header. However, some programmers also use this command as a simplified way to display messages on the own virtual machine console by using "MSGNOH * <message text>".

So basically, all the MSGNOH command does is to display a message on the Hercules console (like the MESSAGE and MSG commands) but without VM like headers. Therefore the MSGNOH command is not really intended to be used directly from the Hercules console as shown in the example below, although it does not hurt doing so.

See also the MESSAGE and MSG commands in this manual.

7.68.2 Syntax

Descriptive

MSGNOH *parms*

Diagram

▶— MSGNOH — *parms* —————▶

7.68.3 Parameter

parms *parms* specifies the required and optional parameters as described in IBM's VM "CP Commands and Utilities Reference" manual.

7.68.4 Examples

Example 1:

Display a message on the own virtual machine console.

```
18:24:19 msgnoh * transmitted message to VM console
18:24:19 transmitted message to VM console
```

Figure 114: MSGNOH command

7.69 OSTAILOR (Specify intended operating system)

7.69.1 Function

The OSTAILOR command lets you display or (re-)specify the intended operating system. The effect of this parameter is to reduce control panel message traffic by selectively suppressing trace messages for program checks which are considered normal in the specified environment.

The argument *QUIET* suppresses all exception messages, whereas the argument *NULL* suppresses none of them. The other options do suppress some messages and do not suppress other messages depending on the specified operating system.

7.69.2 Syntax

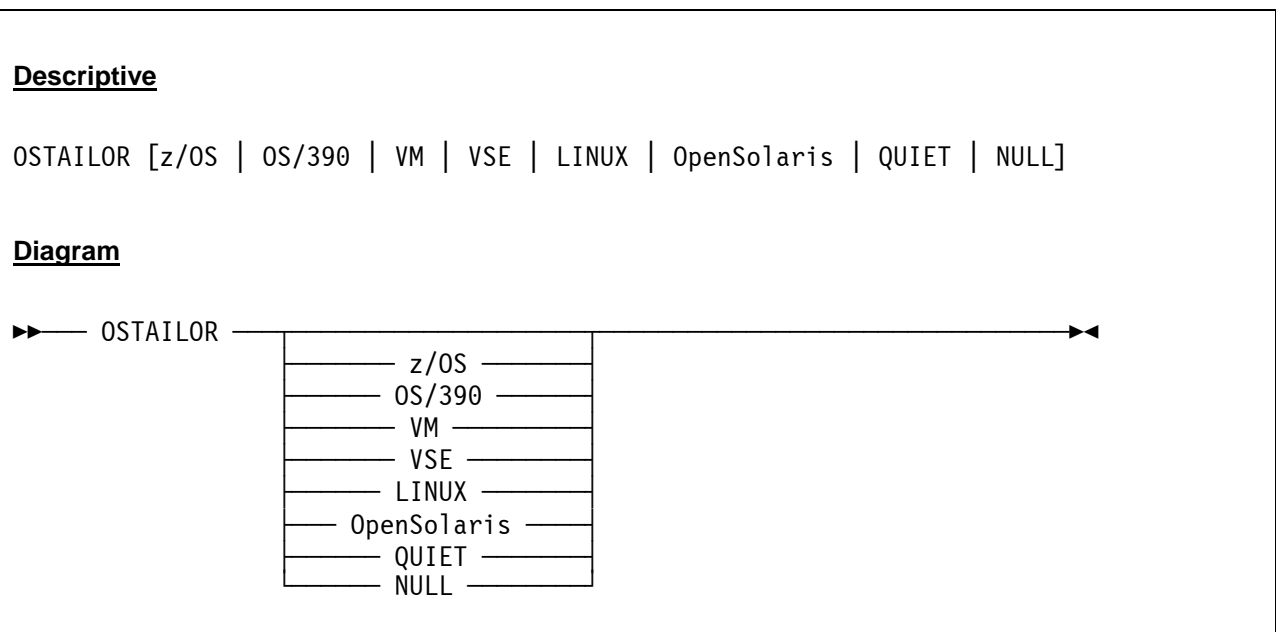

7.69.3 Parameter

z/OS	Code z/OS if you intend to run z/OS.
OS/390	Code OS/390 if you intend to run MVS/370, MVS/XA, MVS/ESA, OS/390.
VM	Code VM if you intend to run VM/370, VM/ESA or z/VM.
VSE	Code VSE if you intend to run VSE/370, VSE/ESA or z/VSE.
LINUX	Code Linux you intend to run Linux/390 or Linux for z/Series.
OpenSolaris	Code OpenSolaris you intend to run OpenSolaris for z/Series.
QUIET	QUIET discards all exception messages.
NULL	NULL allows all exception messages to be logged.

7.69.4 Examples

Example 1:

Display the currently specified intended operating system.

```
2007/06/30 15:11:36.640 00000FC4 ostailor
2007/06/30 15:11:36.671 00000FC4 OSTAILOR z/OS
```

Figure 115: OSTAILOR command (display intended operating system)

Example 2:

Change the specified intended operating system.

```
2007/06/30 15:11:48.187 00000FC4 ostailor linux
2007/06/30 15:11:51.890 00000FC4 ostailor
2007/06/30 15:11:51.890 00000FC4 OSTAILOR LINUX
```

Figure 116: OSTAILOR command (specify intended operating system)

7.70 PANRATE (Display or set console refresh rate)

7.70.1 Function

The PANRATE command shows the current setting of the console (panel) refresh rate and allows a new value to be set.

7.70.2 Syntax

Descriptive

PANRATE [SLOW | FAST | *rate*]

Diagram

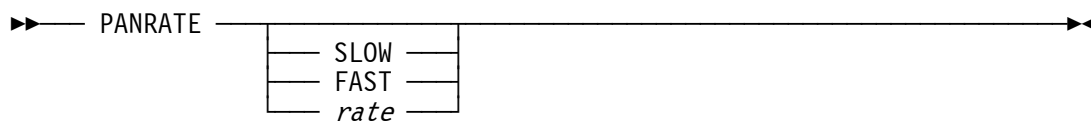

7.70.3 Parameter

SLOW SLOW is a synonym for a panel refresh rate of 500 milliseconds.

FAST FAST is a synonym for a panel refresh rate of 50 milliseconds.

rate Any value between 1 (10) and 5000 milliseconds. A value less than the Linux system clock tick interval (10 on Intel platforms, 1 on Alpha platforms) or a value of more than 5000 will be rejected.

7.70.4 Examples

Example 1:

Display current panel refresh rate.

```
2007/06/30 14:31:53.653 00000FC4 panrate
2007/06/30 14:31:53.653 00000FC4 HHCPN037I Panel refresh rate = 1000 millisecond(s)
```

Figure 117: PANRATE command (list current value)

Example 2:

Set a new panel refresh rate.

```
2007/06/30 14:31:55.623 00000FC4 panrate fast
2007/06/30 14:31:55.623 00000FC4 HHCPN037I Panel refresh rate = 50 millisecond(s)
```

Figure 118: PANRATE command (set new value)

7.71 PGMTRACE (Trace program interrupts)

7.71.1 Function

The PGMTRACE command without arguments displays the actual trace program interrupt options. Given with an argument (interruption code) the command changes the current options. Precede the interruption code with a minus sign to stop tracing of that particular interruption code.

7.71.2 Syntax

Descriptive

PGMTRACE [[-] *intcode*]

Diagram

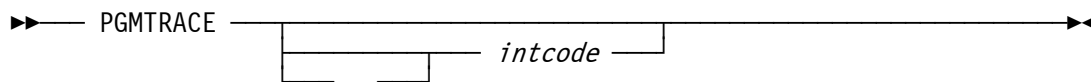

7.71.3 Parameter

- intcode** *intcode* specifies the interruption code for which trace information is to be written to the Hercules log or for which the trace information is to be stopped. *Intcode* has to be a valid program interruption code in the range from 0x01 to 0x40.
- A minus sign, directly preceding the *intcode* parameter, stops tracing for that particular interruption code.

7.71.4 Examples

Example 1:

Display the current program interruption trace settings.

```
12:24:28.718 00000FC4 pgmtrace
12:24:28.718 00000FC4 * = Tracing suppressed; otherwise tracing enabled
12:24:28.718 00000FC4 000000000000000111111111111112222222222222223333333333333334
12:24:28.718 00000FC4 123456789ABCDEF0123456789ABCDEF0123456789ABCDEF0123456789ABCDEF0
12:24:28.718 00000FC4 * * ** * * ** ** * * *
```

Figure 119: PGMTRACE command (display settings)

Example 2:

Change the current program interruption trace settings.

```
12:24:37.781 0000FC4 pgmtrace 04
12:24:41.265 0000FC4 pgmtrace
12:24:41.265 0000FC4 * = Tracing suppressed; otherwise tracing enabled
12:24:41.265 0000FC4 0000000000000000111111111111111122222222222222223333333333333334
12:24:41.265 0000FC4 123456789ABCDEF0123456789ABCDEF0123456789ABCDEF0123456789ABCDEF0
12:24:41.265 0000FC4          *          **          *          *          **          **          *          *          *          *
```

Figure 120: PGMTRACE command (change settings)

7.72 PR (Display prefix register)

7.72.1 Function

The PR command displays the contents of the prefix registers.

7.72.2 Syntax

Descriptive

PR

Diagram

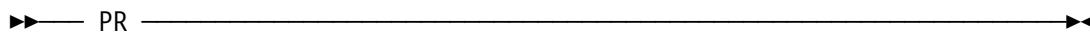

▶▶ — PR ————— ◀◀

7.72.3 Parameter

None.

7.72.4 Examples

Example 1:

Display the prefix register.

```
2007/06/30 14:25:13.997 00000FC4 pr
2007/06/30 14:25:13.997 00000FC4 Prefix=3FBE3000
```

Figure 121: PR command

7.73 PSCP (Send system control program priority message)

7.73.1 Function

The PSCP command sends a system control program (i.e. guest operating system) priority command in any CMDTGT mode.

7.73.2 Syntax

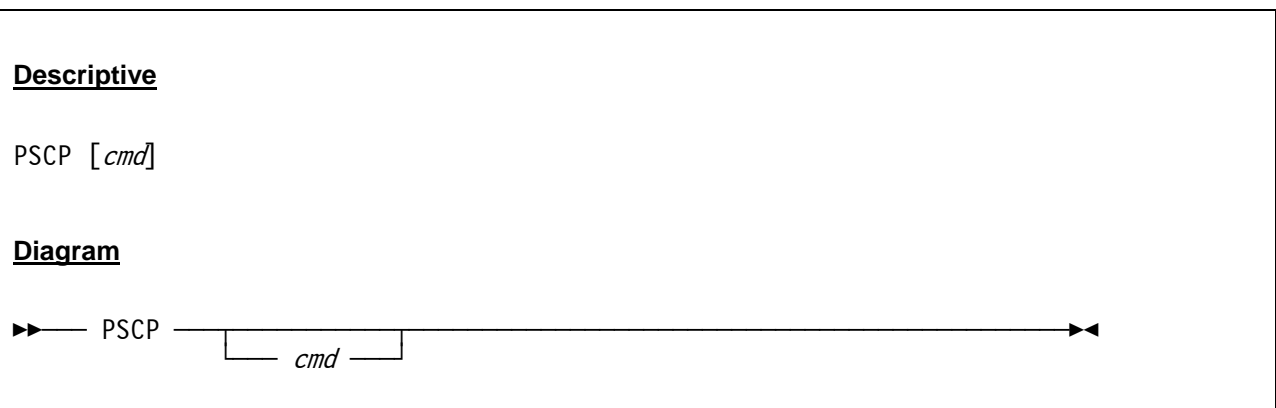

7.73.3 Parameter

cmd This is the command to be sent as a system control program (i.e. guest operating system) priority command.

7.73.4 Examples

For a similar sample please refer to the SCP command.

7.74 PSW (Display or alter program status word)

7.74.1 Function

The PSW command displays or alters the actual content of the Program Status Word (PSW).

7.74.2 Syntax

Descriptive

PSW [*operand=value* [*operand=value ...*]]

where operand is one of the following:

SM=*xx*

PK=*nn*

CMWP=*x*

AS=[PRI | SEC | HOME]

CC=*n*

PM=*x*

IA=*xxxxxxxx*

AM=[24 | 31 | 64]

Diagram

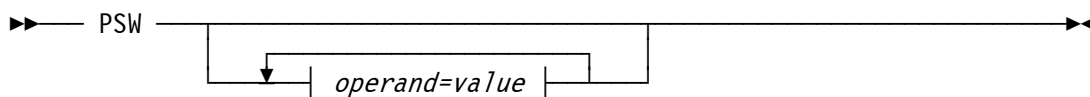

where operand is one of the following:

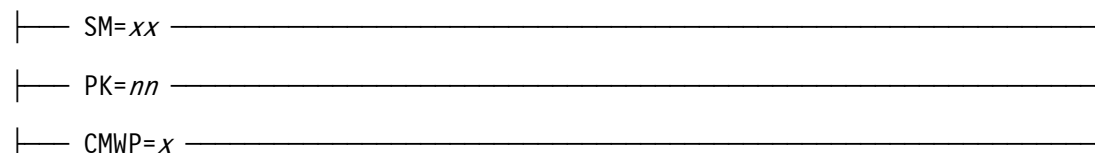

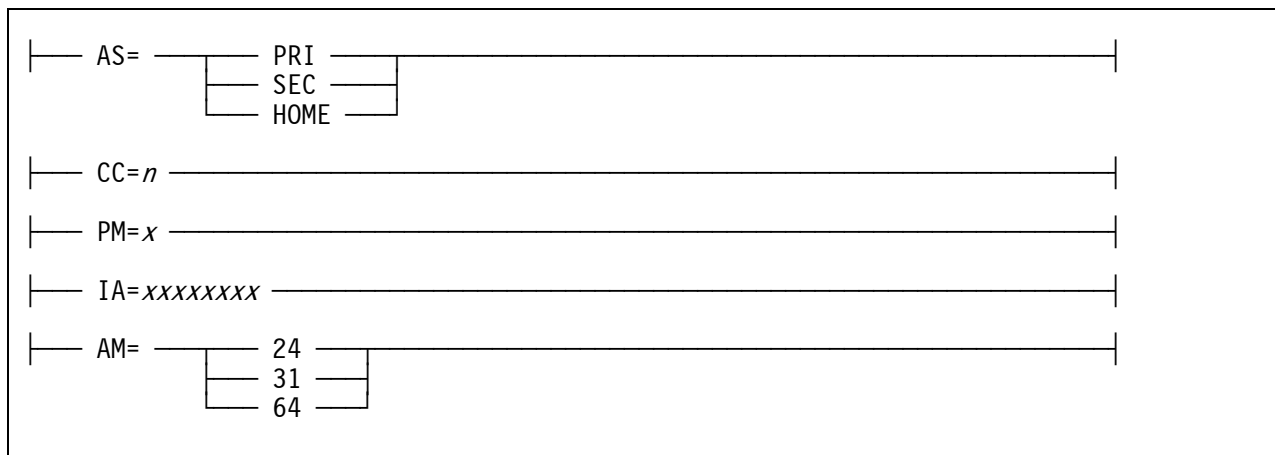

7.74.3 Parameter

SM=xx	Modifies the PSW system mask (xx is 2 hexadecimal digits).
PK=nn	Modifies the PSW protection key (nn is decimal 0 to 15).
CMWP=x	Modifies the EC/M/W/P bits of the PSW (x is 1 hexadecimal digit).
AS=[pri sec home]	This modifies the PSW address space control bits.
CC=n	Modifies the PSW condition code (n is decimal 0 to 3).
PM=x	Modifies the PSW program mask (x is one hexadecimal digit).
IA=xxxxxxxx	Modifies the PSW instruction address (xxxxxxxx is one to 16 hexadecimal digits).
AM=[24 31 64]	Modifies the addressing mode bits of the PSW.

7.74.4 Examples

Example 1:

Display the Program Status Word.

```
2007/12/07 07:04:31.609 00000DBC psw
2007/12/07 07:04:31.609 00000DBC psw sm=04 pk=0 cmwp=C as=ar cc=2 pm=0 am=31 ia=15E43D8
2007/12/07 07:04:31.609 00000DBC PSW=040C6000 815E43EA
```

Figure 122: PSW command (display PSW).

Example 2:

Change the PSW condition code to zero.

```
2007/12/07 07:05:09.685 00000DBC psw cc=0
2007/12/07 07:05:09.685 00000DBC psw sm=04 pk=0 cmwp=C as=ar cc=0 pm=0 am=31 ia=15E43D8
2007/12/07 07:05:09.685 00000DBC PSW=040C4000 815E43D8
```

Figure 123: PSW command (modify PSW)

Example 3:

Change the PSW condition code to zero and the addressing mode bits to AM=24.

```
2007/12/07 07:10:49.006 00000DBC psw cc=0 am=24
2007/12/07 07:10:49.006 00000DBC psw sm=04 pk=0 cmwp=C as=ar cc=0 pm=0 am=24 ia=15E43D8
2007/12/07 07:10:49.006 00000DBC PSW=040C4000 815E43EA
```

Figure 124: PSW command (modify PSW)

7.75 PTT (Set / display pthread trace)

7.75.1 Function

The PTT command sets or displays the internal trace options. When specified with no operands, the PTT command displays the trace options and the contents of the internal trace table.

When specified with operands, the PTT command sets the trace options and/or specifies which events are to be traced. If the last operand is numeric, it sets the size of the trace table and activates the trace.

The following events can be traced:

- error trace
- control trace
- program interrupt trace
- interlock failure trace
- sie trace
- signaling trace
- i/o trace
- timer trace
- thread trace
- logger trace
- lock trace buffer
- timestamp trace entries

7.75.2 Syntax

Descriptive

```
PTT [NOERROR | ERROR] [NOCONTROL | CONTROL] [NOPROG | PROG] [NOINTER | INTER]
    [NOSIE | SIE] [NOSIGNAL | SIGNAL] [NOIO | IO] [NOTIMER | TIMER]
    [NOTHREADS | THREADS] [NOLOCK | LOCK] [NOTOD | TOD] [NOLOGGER | LOGGER]
    [NOWRAP | WRAP] [TO=nnn] [mmmmm]
```

Diagram

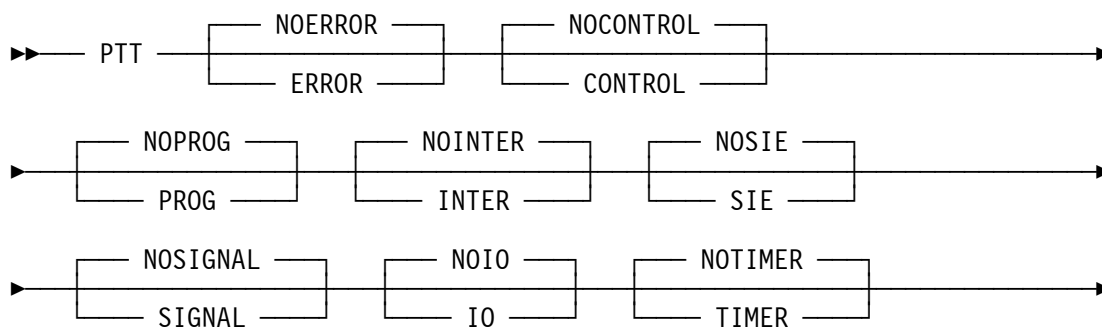

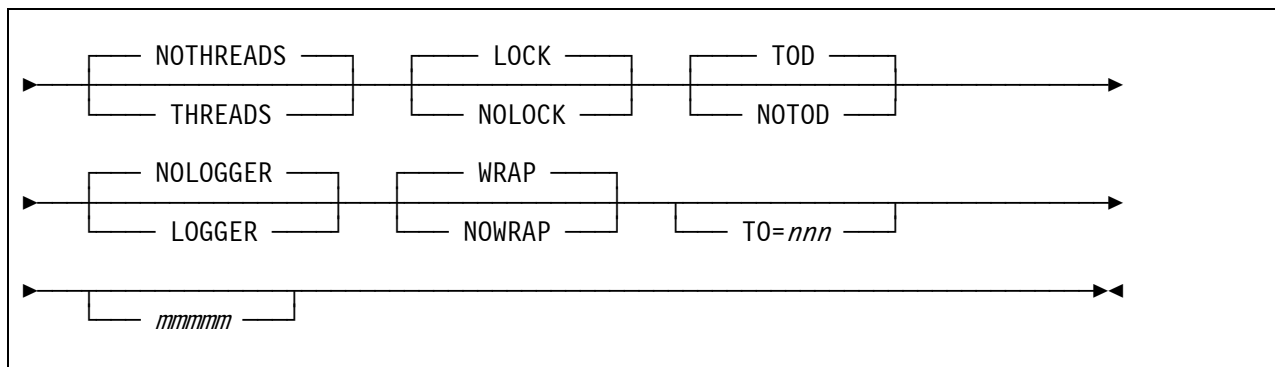

7.75.3 Parameter

NOxxxxxxx	Deselects the specified trace entry type or deselects the specified option.
ERROR	Selects the error trace entries.
CONTROL	Selects the control trace entries.
PROG	Selects the program interrupt trace entries.
INTER	Selects the interlock failure trace entries.
SIE	Selects the sie trace entries.
SIGNAL	Selects the signaling trace entries.
IO	Select the i/o trace entries.
TIMER	Selects the timer trace entries.
THREADS	Selects the thread trace entries.
LOCK	Selects the lock trace buffer entries.
TOD	Selects the timestamp trace entries.
LOGGER	Selects the logger trace entries.
WRAP	Specifies that the trace table has be overwritten when it is full. As soon as the end of the table is reached, the next entry to be written to the table goes to the start and overlays the trace entry that was formerly there.
TO=nnn	Timeout in seconds before the automatic issuance of the PTT command is to occur, to print (display) the internal trace table.
mmmmm	Number of trace entries to be kept.

7.75.4 Examples

Example 1:

Display the current defaults, then set the pthread trace options and start the trace.

```
2009/03/13 10:33:33.359 000003BC ptt
2009/03/13 10:33:33.359 000003BC HHCPT003I ptt lock tod wrap to=0 0
2009/03/13 10:33:33.359 000003BC ptt prog inter signal io threads logger nowrap 10000
```

Figure 125: PTT command (display trace options / set options and start trace)

Example 2:

Display the pthread trace entries.

```
14:04:35 ptt
14:04:35 0000ed0 lock before 007c3684 00000000 control.c:5483 14:04:07.509191
14:04:35 0000ed0 lock after 007c3684 00000000 control.c:5483 14:04:07.509201 0
14:04:35 0000ed0 unlock 007c3684 00000000 control.c:5483 14:04:07.509206 0
14:04:35 0000ed0 STSCH 00010013 000320c0 io.c:664 14:04:07.509496 00000ac4
14:04:35 0000ed0 lock before 012c0c88 00000000 io.c:689 14:04:07.509524
14:04:35 0000ed0 lock after 012c0c88 00000000 io.c:689 14:04:07.509526 0
14:04:35 0000ed0 unlock 012c0c88 00000000 io.c:694 14:04:07.509528 0
14:04:35 0000ed0 SSCH 00010013 00000470 io.c:516 14:04:07.509543 00000ac4
14:04:35 0000ed0 lock before 012c0c88 00000000 channel.c:2199 14:04:07.509546
14:04:35 0000ed0 lock after 012c0c88 00000000 channel.c:2199 14:04:07.509548 0
14:04:35 0000ed0 unlock 012c0c88 00000000 channel.c:2297 14:04:07.509550 0
14:04:35 0000ed0 lock before 012c0c88 00000000 channel.c:2430 14:04:07.509576
14:04:35 0000ed0 lock after 012c0c88 00000000 channel.c:2430 14:04:07.509578 0
14:04:35 0000ed0 unlock 012c0c88 00000000 channel.c:2460 14:04:07.509580 0
14:04:35 0000ed0 lock before 012c194c 00000000 cckddasd.c:479 14:04:07.509584
14:04:35 0000ed0 lock after 012c194c 00000000 cckddasd.c:479 14:04:07.509586 0
14:04:35 0000ed0 lock before 004bd998 00000000 cache.c:141 14:04:07.509588
14:04:35 0000ed0 lock after 004bd998 00000000 cache.c:141 14:04:07.509589 0
14:04:35 0000ed0 unlock 004bd998 00000000 cache.c:148 14:04:07.509607 0
14:04:35 0000ed0 unlock 012c194c 00000000 cckddasd.c:519 14:04:07.509612 0
14:04:35 0000ed0 lock before 012c194c 00000000 cckddasd.c:546 14:04:07.509623
14:04:35 0000ed0 lock after 012c194c 00000000 cckddasd.c:546 14:04:07.509625 0
14:04:35 0000ed0 lock before 004bd998 00000000 cache.c:141 14:04:07.509627
14:04:35 0000ed0 lock after 004bd998 00000000 cache.c:141 14:04:07.509629 0
14:04:35 0000ed0 unlock 004bd998 00000000 cache.c:148 14:04:07.509631 0
14:04:35 0000ed0 unlock 012c194c 00000000 cckddasd.c:564 14:04:07.509632 0
14:04:35 0000ed0 lock before 012c0c88 00000000 channel.c:3269 14:04:07.509634
14:04:35 0000ed0 lock after 012c0c88 00000000 channel.c:3269 14:04:07.509636 0
14:04:35 0000ed0 lock before 007c368c 00000000 channel.c:3333 14:04:07.509638
14:04:35 0000ed0 lock after 007c368c 00000000 channel.c:3333 14:04:07.509639 0
14:04:35 0000ed0 unlock 007c368c 00000000 channel.c:3333 14:04:07.509641 0
14:04:35 0000ed0 unlock 012c0c88 00000000 channel.c:3335 14:04:07.509642 0
14:04:35 0000ed0 lock before 007c3684 00000000 channel.c:3338 14:04:07.509644
14:04:35 0000ed0 lock after 007c3684 00000000 channel.c:3338 14:04:07.509646 0
14:04:35 0000ed0 lock before 007c368c 00000000 channel.c:3340 14:04:07.509647
14:04:35 0000ed0 lock after 007c368c 00000000 channel.c:3340 14:04:07.509649 0
14:04:35 0000ed0 unlock 007c368c 00000000 channel.c:3340 14:04:07.509651 0
14:04:35 0000ed0 unlock 007c3684 00000000 channel.c:3341 14:04:07.509652 0
14:04:35 0000ed0 lock before 007c3684 00000000 cpu.c:1555 14:04:07.509663
14:04:35 0000ed0 lock after 007c3684 00000000 cpu.c:1555 14:04:07.509665 0
14:04:35 0000ed0 lock before 007c368c 00000000 channel.c:3504 14:04:07.509666
14:04:35 0000ed0 lock after 007c368c 00000000 channel.c:3504 14:04:07.509668 0
14:04:35 0000ed0 unlock 007c368c 00000000 channel.c:3543 14:04:07.509677 0
14:04:35 0000ed0 lock before 012c0c88 00000000 channel.c:3555 14:04:07.509681
14:04:35 0000ed0 lock after 012c0c88 00000000 channel.c:3555 14:04:07.509683 0
14:04:35 0000ed0 lock before 007c368c 00000000 channel.c:3558 14:04:07.509684
14:04:35 0000ed0 lock after 007c368c 00000000 channel.c:3558 14:04:07.509694 0
14:04:35 0000ed0 unlock 007c368c 00000000 channel.c:3634 14:04:07.509697 0
14:04:35 0000ed0 unlock 012c0c88 00000000 channel.c:3635 14:04:07.509699 0
14:04:35 0000ed0 *IOINT 00010013 00000000 cpu.c:1159 14:04:07.509701 00000000
```



```

14:04:35 0000ed0 unlock      007c3684 00000000 cpu.c:1241    14:04:07.509704 0
14:04:35 0000ed0 STSCH      00010013 000320c0 io.c:664     14:04:07.509709 0000eb8
14:04:35 0000ed0 lock before 012c0c88 00000000 io.c:689     14:04:07.509711
14:04:35 0000ed0 lock after  012c0c88 00000000 io.c:689     14:04:07.509712 0
14:04:35 0000ed0 unlock      012c0c88 00000000 io.c:694     14:04:07.509714 0
14:04:35 0000ed0 TSCH       00010013 00032060 io.c:837     14:04:07.509716 0000eb8
14:04:35 0000ed0 lock before 012c0c88 00000000 channel.c:600 14:04:07.509724
14:04:35 0000ed0 lock after  012c0c88 00000000 channel.c:600 14:04:07.509726 0
14:04:35 0000ed0 lock before 007c368c 00000000 channel.c:799 14:04:07.509729
14:04:35 0000ed0 lock after  007c368c 00000000 channel.c:799 14:04:07.509731 0
14:04:35 0000ed0 unlock      007c368c 00000000 channel.c:799 14:04:07.509732 0
14:04:35 0000ed0 unlock      012c0c88 00000000 channel.c:801 14:04:07.509734 0
14:04:35 0000ed0 lock before 007c3684 00000000 channel.c:804 14:04:07.509736
14:04:35 0000ed0 lock after  007c3684 00000000 channel.c:804 14:04:07.509738 0
14:04:35 0000ed0 lock before 007c368c 00000000 channel.c:805 14:04:07.509740
14:04:35 0000ed0 lock after  007c368c 00000000 channel.c:805 14:04:07.509741 0
14:04:35 0000ed0 unlock      007c368c 00000000 channel.c:805 14:04:07.509743 0
14:04:35 0000ed0 unlock      007c3684 00000000 channel.c:806 14:04:07.509745 0
14:04:35 0000ed0 STSCH      00010013 000320c0 io.c:664     14:04:07.509779 0000ac4
14:04:35 0000ed0 lock before 012c0c88 00000000 io.c:689     14:04:07.509782
14:04:35 0000ed0 lock after  012c0c88 00000000 io.c:689     14:04:07.509784 0
14:04:35 0000ed0 unlock      012c0c88 00000000 io.c:694     14:04:07.509786 0
14:04:35 0000ed0 SSCH       00010013 00000450 io.c:516     14:04:07.509790 0000ac4
14:04:35 0000ed0 lock before 012c0c88 00000000 channel.c:2199 14:04:07.509792
14:04:35 0000ed0 lock after  012c0c88 00000000 channel.c:2199 14:04:07.509793 0
14:04:35 0000ed0 unlock      012c0c88 00000000 channel.c:2297 14:04:07.509795 0
14:04:35 0000ed0 lock before 012c0c88 00000000 channel.c:2430 14:04:07.509798
14:04:35 0000ed0 lock after  012c0c88 00000000 channel.c:2430 14:04:07.509799 0
14:04:35 0000ed0 unlock      012c0c88 00000000 channel.c:2460 14:04:07.509801 0
14:04:35 0000ed0 lock before 012c194c 00000000 cckddasd.c:479 14:04:07.509803
14:04:35 0000ed0 lock after  012c194c 00000000 cckddasd.c:479 14:04:07.509805 0
14:04:35 0000ed0 lock before 004bd998 00000000 cache.c:141  14:04:07.509806
.
.
.

```

Figure 126: PTT command (display trace entries)

Example 3:

Set the pthread trace options, start the trace and issue automatic display of the trace entries after 2 minutes.

```

2009/03/13 10:48:25.248 000003BC ptt prog inter signal io threads logger nowrap to=120 10000

```

Figure 127: PTT command (start trace and issue automatic display)

7.76 PWD (Print working directory)

7.76.1 Function

The PWD command prints the current working directory.

7.76.2 Syntax

Descriptive

PWD

Diagram

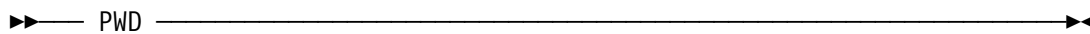

▶— PWD —————▶

7.76.3 Parameter

None.

7.76.4 Examples

Example 1:

Print the current working directory.

```
2007/08/23 00:50:46.859 00000B54 pwd
2007/08/23 00:50:46.859 00000B54 D:\Hercules
```

Figure 128: PWD command

7.77 QD (Query DASD)

7.77.1 Function

The QD command queries one or all (depending on the argument given) DASD devices.

7.77.2 Syntax

Descriptive

QD [*address*]

Diagram

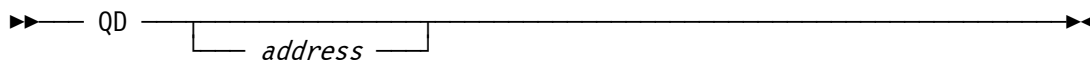

7.77.3 Parameter

address The address of the DASD device to be queried. If no address is given, then a query for all DASD devices is listed.

7.77.4 Examples

Example 1:

Query DASD device with address 0AE0.

```
02:55:40.954 000009EC qd 0ae0
02:55:40.954 000009EC 0ae0 SNSID 00 ff3990e9 33900a00 40fa0100 41270004
02:55:40.954 000009EC          10 423e0060
02:55:40.954 000009EC 0ae0 RDC   00 3990e933 900a5000 30972024 0d0b000f
02:55:40.954 000009EC          10 e000e5a2 05940222 13090674 00000000
02:55:40.954 000009EC          20 00000000 00000000 24241502 dfce0001
02:55:40.954 000009EC          30 0677080f 00004800 15ff0000 00000000
02:55:40.954 000009EC 0ae0 RCD   00 c4010100 4040f3f3 f9f0f0f0 c1c8d9c3 |D... 339000AHRC|
02:55:40.954 000009EC          10 e9e9f0f0 f0f0f0f0 f0f0f0f0 f0f10300 |ZZ000000000001..|
02:55:40.954 000009EC          20 c4000000 4040f3f3 f9f0f0f0 c1c8d9c3 |D... 339000AHRC|
02:55:40.954 000009EC          30 e9e9f0f0 f0f0f0f0 f0f0f0f0 f0f10300 |ZZ000000000001..|
02:55:40.954 000009EC          40 d4020000 4040f3f9 f9f0f0c5 f9c8d9c3 |M... 39900E9HRC|
02:55:40.954 000009EC          50 e9e9f0f0 f0f0f0f0 f0f0f0f0 f0f10300 |ZZ000000000001..|
02:55:40.954 000009EC          60 f0000001 4040f3f9 f9f04040 40c8d9c3 |0... 3990 HRC|
02:55:40.954 000009EC          70 e9e9f0f0 f0f0f0f0 f0f0f0f0 f0f10300 |ZZ000000000001..|
02:55:40.954 000009EC          80 00000000 00000000 00000000 00000000 |.....|
02:55:40.954 000009EC          90 00000000 00000000 00000000 00000000 |.....|
```

02:55:40.954	000009EC	a0	00000000	00000000	00000000	00000000
02:55:40.970	000009EC	b0	00000000	00000000	00000000	00000000
02:55:40.970	000009EC	c0	00000000	00000000	00000000	00000000
02:55:40.970	000009EC	d0	00000000	00000000	00000000	00000000
02:55:40.970	000009EC	e0	80000007	00001e00	0ae080e0	e0e00700\.\.\.\.
02:55:40.970	000009EC	f0	008080e0	00000000	00000000	00000000	...\.\.\.\.\.
02:55:40.970	000009EC	0ae0 SNSS	00	01e01f00	00000000	00000000	00000000
02:55:40.970	000009EC	10	00000000	00000000	00000000	00000000	
02:55:40.970	000009EC	20	00000000	00000ae0	00000000		

Figure 129: QD command

7.77.5 Explanations

The Sense ID (SNSID) is describing the type and the model number of the subsystem and logical volume of the channel and has the following format:

Bytes	Description
0	---
1-2	Subsystem Type
3	Subsystem Model and Architecture
4-5	Device Type
6	Device Model
7	Reserved
8-11	Command Interface Word (CIW) for Read Configuration Data
12-15	Command Interface Word (CIW) for Set-Interface-Identifier
16-19	Command Interface Word (CIW) for Read-Node-Identifier

Table 12: Sense ID

The Read Device Characteristics (RDC) defines the characteristics of the logical volume. The format is the following:

Bytes	Description
0-1	Subsystem type
2	Subsystem model number and architecture
3-4	Device type
5	Device model
6-9	Subsystem and device facilities
10	Device class code
11	Device type code
12-13	Number of primary cylinders
14-15	Tracks per cylinder
16	Number of sectors
17-19	Track length
20-21	Length of HA and R0
22	Track capacity calculation formula
23-27	Track capacity calculation factors F1 through F5

28-29	First alternate cylinder address
30-31	Number of alternate tracks
32-33	First diagnostic cylinder address
34-35	Number of diagnostic tracks
36-37	First device support cylinder address
38-39	number of device support tracks
40	MDR record ID
41	OBR record ID
42	Control unit type code
43	Read trackset parameter length
44-45	Maximum record zero length
46	Reserved
47	Track set size
48	Track capacity calculation factor F6
49-50	RPS sector calculation factors
51-53	Reserved
54	Device and control unit features
55	Reserved
56	Real control unit type code
57	Real device type code
58-63	Reserved

Table 13: Read Device Characteristics

The Read Configuration Data (RCD) contains configuration data. It shows how the internal disk subsystem is configured. The RCD has the following format:

Bytes	Name	Description
000-031	NED1	Volume NED (logical volume within the subsystem)
032-063	NED2	NED for the RAID array
064-095	NED3	NED for the logical subsystem
096-127	NED4	Token NED (establishes a relationship among all configuration data records in a control unit in the subsystem)
128-223		Reserved
224-255	QNEQ	General NEQ (describes paths and addresses)

Table 14: Read Configuration Data

Legend:

NED Node Element Descriptor

NEQ Node Element Qualifier

7.78 QUIET (Toggle automatic refresh of console display data)

7.78.1 Function

The QUIET command either disables automatic screen refreshing if it is currently enabled or enables it if it is currently disabled. When disabled you will not be able to see the response of any entered commands nor any messages issued by the system nor be able to scroll the display, etc. Basically all screen updating is disabled. Entering 'quiet' again re-enables screen updating.

Please note, that the QUIET command is disabled in the dyngui and therefore is not available when using the Hercules WinGUI.

7.78.2 Syntax

<p><u>Descriptive</u></p> <p>QUIET</p> <p><u>Diagram</u></p> <p>▶— QUIET —————▶</p>

7.78.3 Parameter

None.

7.78.4 Examples

Example 1:

Change between automatic refresh of console display data.

```
2007/06/30 13:30:43.062 00000618 quiet
2007/06/30 13:30:43.062 00000618 HHCPN027I Automatic refresh disabled.
2007/06/30 13:30:47.906 00000618 quiet
2007/06/30 13:30:47.906 00000618 HHCPN027I Automatic refresh enabled.
```

Figure 130: QUIET command

7.79 QUIT (Terminate the emulator)

7.79.1 Function

The QUIT command (see also the EXIT command) initiates the Hercules shutdown. It terminates all threads, detaches all channels and devices and releases the configuration. Finally it terminates the emulator.

7.79.2 Syntax

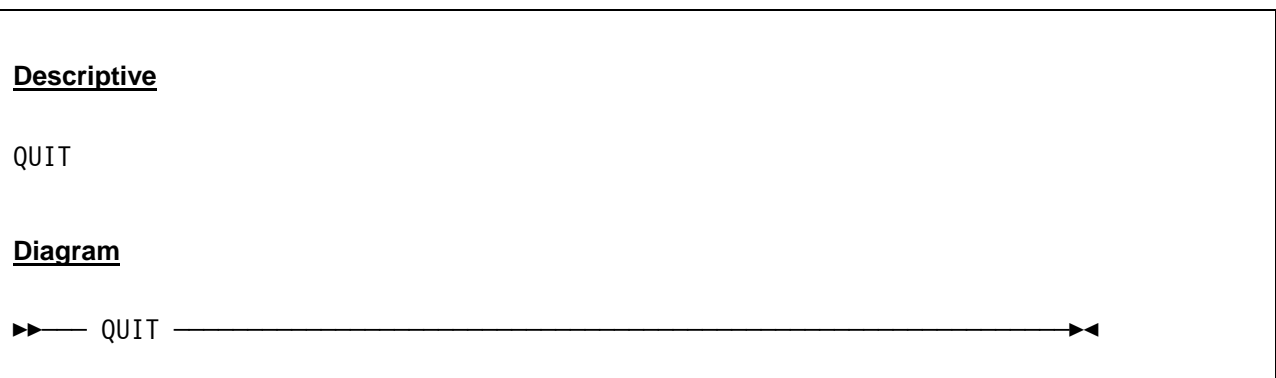

7.79.3 Parameter

None.

7.79.4 Examples

Example 1:

Initiate the Hercules shutdown.

```
2007/06/30 2007/06/30 14:49:57.044 00000FC4 quit
2007/06/30 2007/06/30 14:49:57.044 00000FC4 HHCIN900I Begin Hercules shutdown
2007/06/30 2007/06/30 14:49:57.044 00000FC4 HHCIN901I Releasing configuration
2007/06/30 2007/06/30 14:49:57.044 00000FC4 HHCCP008I CPU0000 thread ended: tid=0000049C,pid=232
2007/06/30 2007/06/30 14:49:57.044 00000FC4 HHCCP008I CPU0001 thread ended: tid=0000046C,pid=232
2007/06/30 2007/06/30 14:49:57.044 00000FC4 HHCCF047I Subchannel 0000 detached
2007/06/30 2007/06/30 14:49:57.044 00000FC4 HHCCF047I Subchannel 0001 detached
2007/06/30 2007/06/30 14:49:57.044 00000FC4 HHCCF047I Subchannel 0002 detached
2007/06/30 2007/06/30 14:49:57.059 00000FC4 HHCTT003I Timer thread ended
2007/06/30 2007/06/30 14:49:57.059 00000FC4 HHCCF047I Subchannel 0003 detached
2007/06/30 2007/06/30 14:49:57.059 00000FC4 HHCCF047I Subchannel 0004 detached
2007/06/30 2007/06/30 14:49:57.059 00000FC4 HHCCF047I Subchannel 0005 detached
2007/06/30 2007/06/30 14:49:57.059 00000FC4 HHCCF047I Subchannel 0006 detached
2007/06/30 2007/06/30 14:49:57.059 00000FC4 HHCCF047I Subchannel 0007 detached
2007/06/30 2007/06/30 14:49:57.059 00000FC4 HHCCF047I Subchannel 0008 detached
2007/06/30 2007/06/30 14:49:57.059 00000FC4 HHCCF047I Subchannel 0009 detached
2007/06/30 2007/06/30 14:49:57.059 00000FC4 HHCCF047I Subchannel 000A detached
```

```

2007/06/30 2007/06/30 14:49:57.059 00000FC4 HHCCF047I Subchannel 000B detached
2007/06/30 2007/06/30 14:49:57.059 00000FC4 HHCCF047I Subchannel 000C detached
2007/06/30 2007/06/30 14:49:57.059 00000FC4 HHCCF047I Subchannel 000D detached
2007/06/30 2007/06/30 14:49:57.059 00000FC4 HHCCF047I Subchannel 000E detached
2007/06/30 2007/06/30 14:49:57.059 00000FC4 HHCCF047I Subchannel 000F detached
2007/06/30 2007/06/30 14:49:57.059 00000FC4 HHCCF047I Subchannel 0010 detached
2007/06/30 2007/06/30 14:49:57.059 00000FC4 HHCCF047I Subchannel 0011 detached
2007/06/30 2007/06/30 14:49:57.059 00000FC4 HHCCF047I Subchannel 0012 detached
2007/06/30 2007/06/30 14:49:57.059 00000FC4 HHCCF047I Subchannel 0013 detached
2007/06/30 2007/06/30 14:49:57.059 00000FC4 HHCTE004I Console connection thread terminated
2007/06/30 2007/06/30 14:49:57.059 00000FC4 HHCD A023I 0300 cache hits 812, misses 114, waits 0
2007/06/30 2007/06/30 14:49:57.059 00000FC4 HHCCF047I Subchannel 0014 detached
2007/06/30 2007/06/30 14:49:57.059 00000FC4 HHCD A023I 0310 cache hits 5, misses 7, waits 0
2007/06/30 2007/06/30 14:49:57.059 00000FC4 HHCCF047I Subchannel 0015 detached
2007/06/30 2007/06/30 14:49:57.059 00000FC4 HHCD A023I 0320 cache hits 271, misses 35, waits 0
2007/06/30 2007/06/30 14:49:57.059 00000FC4 HHCCF047I Subchannel 0016 detached
2007/06/30 2007/06/30 14:49:57.059 00000FC4 HHCD A023I 0330 cache hits 137, misses 59, waits 0
2007/06/30 2007/06/30 14:49:57.059 00000FC4 HHCCF047I Subchannel 0017 detached
.
.
.
2007/06/30 2007/06/30 14:49:57.075 00000FC4 HHCCF047I Subchannel 0028 detached
2007/06/30 2007/06/30 14:49:57.075 00000FC4 HHCCF047I Subchannel 0029 detached
2007/06/30 2007/06/30 14:49:57.075 00000FC4 HHCCF047I Subchannel 002A detached
2007/06/30 2007/06/30 14:49:57.075 00000FC4 HHCCF047I Subchannel 002B detached
2007/06/30 2007/06/30 14:49:57.075 00000FC4 HHCCF047I Subchannel 002C detached
2007/06/30 2007/06/30 14:49:57.075 00000FC4 HHCCF047I Subchannel 002D detached
2007/06/30 2007/06/30 14:49:57.075 00000FC4 HHCCF047I Subchannel 002E detached
2007/06/30 2007/06/30 14:49:59.841 00000FC4 HHCCF047I Subchannel 002F detached
2007/06/30 2007/06/30 14:49:59.841 00000FC4 HHCIN902I Configuration release complete
2007/06/30 2007/06/30 14:49:59.841 00000FC4 HHCIN903I Calling termination routines
2007/06/30 2007/06/30 14:49:59.841 00000FC4 HHCHD900I Begin shutdown sequence
2007/06/30 2007/06/30 14:49:59.841 00000FC4 HHCHD901I Calling console_shutdown
2007/06/30 2007/06/30 14:49:59.841 00000FC4 HHCHD902I console_shutdown complete
2007/06/30 2007/06/30 14:49:59.841 00000FC4 HHCHD901I Calling hdl_term
2007/06/30 2007/06/30 14:49:59.841 00000FC4 HHCHD950I Begin HDL termination sequence
2007/06/30 2007/06/30 14:49:59.841 00000FC4 HHCHD951I Calling module dyngui cleanup routine
2007/06/30 2007/06/30 14:49:59.950 00000FC4 HHCHD952I Module dyngui cleanup complete
2007/06/30 2007/06/30 14:49:59.950 00000FC4 HHCHD951I Calling module *Hercules cleanup routine
2007/06/30 2007/06/30 14:49:59.950 00000FC4 HHCHD952I Module *Hercules cleanup complete
2007/06/30 2007/06/30 14:49:59.950 00000FC4 HHCHD959I HDL Termination sequence complete
2007/06/30 2007/06/30 14:49:59.950 00000FC4 HHCHD902I hdl_term complete
2007/06/30 2007/06/30 14:49:59.950 00000FC4 HHCHD901I Calling logger_term
2007/06/30 2007/06/30 14:49:59.950 00000FC4 HHCLG014I logger thread terminating
2007/06/30 2007/06/30 14:49:59.950 00000FC4 HHCLG014I logger thread terminating
2007/06/30 2007/06/30 14:49:59.950 00000FC4 HHCIN099I Hercules terminated

```

Figure 131: QUIT command

```

11:00:58.171 00000FC4 R:00000080:K:0E=00000000 00002401 00020078 00020011 .....
11:00:58.171 00000FC4 R:00000090:K:0E=0004B000 00000000 00000000 00000000 .....
11:00:58.171 00000FC4 R:000000A0:K:0E=00000000 013B8188 00000000 00000000 .....ah.....
11:00:58.171 00000FC4 R:000000B0:K:0E=00000000 00000000 00010009 00F3CC08 .....3..
11:00:58.171 00000FC4 R:000000C0:K:0E=28000000 00000000 00000000 00000000 .....
11:00:58.171 00000FC4 R:000000D0:K:0E=00000000 0F5D2000 00000000 00000000 .....).
11:00:58.171 00000FC4 R:000000E0:K:0E=00000000 00000000 00000000 00000000 .....
11:00:58.171 00000FC4 R:000000F0:K:0E=00000000 00000000 00000000 00000000 .....

```

Figure 132: R command (display real storage)

Example 2:

Alter 4 bytes of real storage at location x'00000000' to x'FFFFFFFF'.

```

11:01:55.015 00000FC4 r 00000000=ffffffff
11:01:55.015 00000FC4 R:00000000:K:0E=FFFFFFFF 81080278 00000000 00000000 ....a.....

```

Figure 133: R command (alter real storage)

7.81 RESTART (Generate restart interrupt)

7.81.1 Function

The RESTART command generates a restart interrupt (the virtual RESTART key is pressed).

7.81.2 Syntax

Descriptive

RESTART

Diagram

▶— RESTART —▶

7.81.3 Parameter

None.

7.81.4 Examples

Example 1:

Generate restart interrupt.

```
2007/06/30 15:30:23.703 00000FC4 restart
2007/06/30 15:30:23.718 00000FC4 HHCPN038I Restart key depressed
```

Figure 134: RESTART command

7.82 RESUME (Resume Hercules)

7.82.1 Function

This command resumes a Hercules session that had been previously suspended with the SUSPEND command (see section 7.108 for details). The data necessary to resume the session is read from a packed (zipped) file called "hercules.srf.gz" located in the current configuration directory.

In order for an instance to be resumed HERCULES must be started with a configuration file describing the configuration at suspend time. For example, MAINSIZE and XPNDSize must match and all devices present at suspend time must be present at resume time.

Disk devices must be at the same state as they were at suspend time. They can however be a different file type. For example a disk could be a CCKD disk at suspend time then a CKD disk could be created using DASDCOPY and HERCULES resumed using the CKD disk instead.

HERCULES must also be configured similarly as at suspend time. For example if 4 emulated CPUs were active at suspend time then the session cannot be resumed on a HERCULES with a maximum of two CPUs. Similarly you will not be able to resume a session in z/Architecture mode for a HERCULES that was built without z/Architecture.

After entering the RESUME command on the Hercules console the suspend file is re-imported and the CPUs are put in the STARTED state again resuming guest program operations at the same point and in the same state as the suspend file was created.

There are some caveats when resuming guest operating system processing:

- As seen by the guest operating system, the TOD clock will appear to jump a large value. Some guests may not cope very well with this. For example some guests may be dismayed because certain interrupts will occur way past its due time. Also for S/370 an interval timer interrupt may be lost if the guest is interrupted for more than half the Interval Timer wrap time (around 8 hours).
- Although some effort has been put in order to make this as transparent as possible (that is, it should appear to the guest operating system that the STOP key was pressed for a large amount of time), some state information may be missed.

Some guest operating systems will fare better if the suspend state is prepared first. For MVS, as an example, it seems to help when a QUIESCE command and a SYSTEM RESTART manual operation are issued prior to suspend the system.

7.82.2 Syntax

Descriptive

RESUME

Diagram

▶— RESUME —▶

7.82.3 Parameter

None.

7.82.4 Examples

Example 1:

Resume a Hercules session.

```
14:16:29.921 00000FC4 resume
14:16:29.921 00000FC4 HHCCP008I CPU0000 thread ended: tid=00000C24, pid=4056
14:16:29.921 00000FC4 HHCCP008I CPU0001 thread ended: tid=0000044C, pid=4056
14:16:29.921 00000FC4 HHCSR001I Resuming suspended file created Wed Jan 11 14:15:43 2006
14:16:29.937 00000FC4 HHCTT003I Timer thread ended
14:16:31.187 00000FC4 HHCCP002I CPU0000 thread started: tid=00000EAC, pid=4056, priority=0
14:16:31.187 00000FC4 HHCCP003I CPU0000 architecture mode ESA/390
14:16:31.187 00000FC4 HHCTT002I Timer thread started: tid=00000760, pid=4056, priority=-20
14:16:31.187 00000FC4 HHCCP002I CPU0001 thread started: tid=00000ED8, pid=4056, priority=0
14:16:31.187 00000FC4 HHCCP003I CPU0001 architecture mode ESA/390
```

Figure 135: RESUME command

7.83 RMMOD (Delete a module)

7.83.1 Function

The RMMOD command deletes (unloads) a module.

7.83.2 Syntax

Descriptive

RMMOD *module*

Diagram

▶— RMMOD — *module* —————▶◀

7.83.3 Parameter

module Name of the module that is to be unloaded. If a device is still bound to the module then a message is issued and the module is not deleted.

7.83.4 Examples

Example 1:

Delete module "dyncrypt".

```
2007/06/30 10:33:33.359 0000008E rmmod dyncrypt
2007/06/30 10:33:33.359 0000008E HHCHD102I Unloading dyncrypt ...
2007/06/30 10:33:33.359 0000008E HHCHD103I Module dyncrypt unloaded
```

Figure 136: RMMOD command

7.84 S (Instruction stepping)

7.84.1 Function

This command sets the instruction stepping and breaking range. The instruction stepping is totally separate from the instruction tracing range (See T command).

A range can be specified. If there is no range then the range includes all addresses. "S 0" eliminates the range and all addresses will be stepped. With or without a given range, the S command displays whether instruction stepping is on or off and the range if any.

The S command by itself does not activate instruction stepping. Use the S+ command to activate instruction stepping.

7.84.2 Syntax

The S command has the following syntax:

Descriptive

S [*addr-addr* | *addr:addr* | *addr.length* | 0]

Diagram

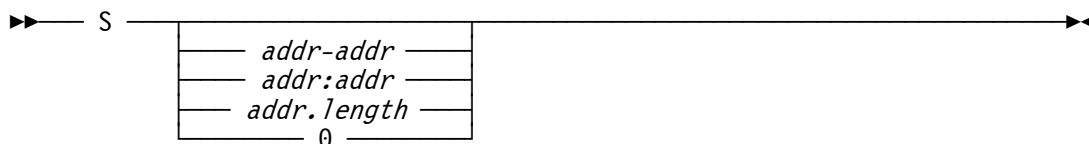

7.84.3 Parameter

addr Specifies an address. The range can be coded as "addr-addr" or "addr:addr" (from begin address to end address) or as *addr.length* (from begin address for length).

length Specifies the length of the range.

0 No range is specified or an existing range is reset. Instruction stepping is active for all addresses.

7.84.4 Examples

Example 1:

Set instruction stepping range.

```
2009/02/15 10:06:22.432 00000FC4 s 1048576-1056768
2009/02/15 10:06:22.432 00000FC4 HHCPN040I Instruction stepping off range 1048576-1056768
```

Figure 137: S command

7.85 S+ (Instruction stepping on)

7.85.1 Function

This command turns on the instruction stepping. After turning instruction stepping on, each ENTER from the console allows Hercules to execute exactly one instruction and lists detailed trace information.

The trace information includes the executing CPU, the PSW, the executed instruction in hexadecimal and in disassembled form as well as register hexadecimal displays of all involved register types.

A range can be specified as for the S command, otherwise the existing range is used. If there is no range (or range was specified as 0) then the range includes all addresses.

When an instruction within the range is about to be executed, the CPU is temporarily stopped and the next instruction is displayed. You may then examine registers and/or storage etc. before you press Enter to execute the instruction and stop at the next instruction. To turn off instruction stepping and continue normal execution enter the G command.

7.85.2 Syntax

Descriptive

S+ [*addr-addr* | *addr:addr* | *addr.length* | 0]

Diagram

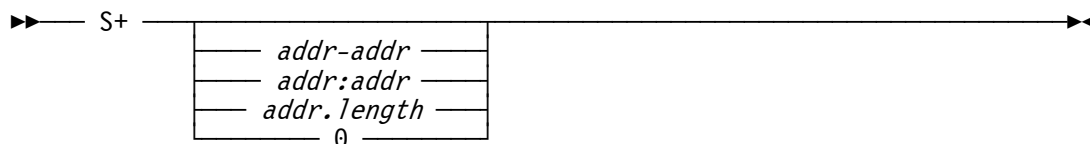

7.85.3 Parameter

- addr** Specifies an address. The range can be coded as “addr–addr” or “addr:addr” (from begin address to end address) or as address.length (from begin address for length).
- length** Specifies the length of the range.
- 0** No range is specified or an existing range is reset. Instruction stepping is active for all addresses.

7.85.4 Examples

Example 1:

Turn on instruction stepping.

```
s+
HHCPN040I Instruction stepping on
CPU0000: PSW=00082000 8000061E INST=D20700680240 MVC 104(8,0),576(0) move_character
CPU0000: R:00000068:K:06=00080000 8000060A 00000000 00000000 .....
CPU0000: R:00000240:K:06=00080000 800009E6 00000000 80000000 .....W.....
CPU0000: GR00=00000000 GR01=00000000 GR02=00000000 GR03=00000000
CPU0000: GR04=00000000 GR05=00000000 GR06=00000000 GR07=00000000
CPU0000: GR08=00000000 GR09=00000000 GR10=00000000 GR11=00000000
CPU0000: GR12=00000000 GR13=00000000 GR14=00000000 GR15=00000000

CPU0000: PSW=00082000 80000624 INST=D20701D00248 MVC 464(8,0),584(0) move_character
CPU0000: R:000001D0:K:06=00000000 80000000 00000000 000009BE .....
CPU0000: R:00000248:K:06=00000000 80000000 00000000 000009BE .....
CPU0000: GR00=00000000 GR01=00000000 GR02=00000000 GR03=00000000
CPU0000: GR04=00000000 GR05=00000000 GR06=00000000 GR07=00000000
CPU0000: GR08=00000000 GR09=00000000 GR10=00000000 GR11=00000000
CPU0000: GR12=00000000 GR13=00000000 GR14=00000000 GR15=00000000

CPU0000: PSW=00082000 8000062A INST=1F55 SLR 5,5 subtract_logical_register
CPU0000: GR00=00000000 GR01=00000000 GR02=00000000 GR03=00000000
CPU0000: GR04=00000000 GR05=00000000 GR06=00000000 GR07=00000000
CPU0000: GR08=00000000 GR09=00000000 GR10=00000000 GR11=00000000
CPU0000: GR12=00000000 GR13=00000000 GR14=00000000 GR15=00000000

CPU0000: PSW=00082000 8000062C INST=1F00 SLR 0,0 subtract_logical_register
CPU0000: GR00=00000000 GR01=00000000 GR02=00000000 GR03=00000000
CPU0000: GR04=00000000 GR05=00000000 GR06=00000000 GR07=00000000
CPU0000: GR08=00000000 GR09=00000000 GR10=00000000 GR11=00000000
CPU0000: GR12=00000000 GR13=00000000 GR14=00000000 GR15=00000000
.
.
.
```

Figure 138: S+ command

7.86 S- (Instruction stepping off)

7.86.1 Function

This command turns off the instruction stepping. To continue normal processing after stopping the instruction stepping use the G command.

7.86.2 Syntax

Descriptive

S-

Diagram

▶▶ — S- —————▶▶

7.86.3 Parameter

None.

7.86.4 Examples

Example 1:

Turn off instruction stepping.

```
2009/02/15 10:07:39.312 00000FC4 s-
2009/02/15 10:07:39.312 00000FC4 HHCPN040I Instruction stepping off range 1048576-1056768
```

Figure 139: S- command

7.87 S? (Instruction stepping query)

7.87.1 Function

The S? command displays whether instruction stepping is on or off and the active range if any.

7.87.2 Syntax

Descriptive

S?

Diagram

▶▶ — S? ————— ▶▶

7.87.3 Parameter

None.

7.87.4 Examples

Example 1:

Query instruction stepping.

```
2009/02/15 10:08:05.112 00000FC4 s?  
2009/02/15 10:08:05.112 00000FC4 HHCPN040I Instruction stepping on range 1048576-1056768
```

Figure 140: S? command

7.88 S{+/-} dev (Turn CCW stepping on or off)

7.88.1 Function

This command turns on (s+ dev) or turns off (s- dev) the CCW stepping function. After CCW stepping is turned on every execution of a CCW has to be confirmed by hitting ENTER on the Hercules console and produces detailed trace output.

7.88.2 Syntax

Descriptive

S{+ | -} devaddr

Diagram

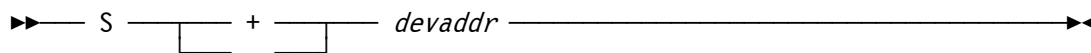

7.88.3 Parameter

- devaddr** This is the address of the device for which CCW stepping will be turned on or off.
- +** The plus sign turns on the CCW stepping for the given device. The plus sign must immediately follow the S command (without an intervening blank).
- The minus sign turns off the CCW stepping for the given device. The minus sign must immediately follow the S command (without an intervening blank).

7.88.4 Examples

Example 1:

Turn on CCW stepping.

```
s+ 0148
HHCPN137I CCW stepping is now on for device 0148
0148:start i/o file[0] bufcur -1 cache[-1]
HHCCP048I 0148:CCW=02000000 60000018=>02000000 60000018 00000000 00000000 .....
0148:HHCDA038I seeking to cyl 0 head 0
0148:read trk 0 (asynchronous)
0148:0 rdtrk 0
0148:0 rdtrk[0] 0 cache miss
0148:0 rdtrk[0] 0 buf 00DA4FB0 len 56832
0148:trk[0] read_trkimg
0148:file[0] l2[0,0] trk[0] read_l2ent 0x710
0148:file[0] read_l2 0 active -1 -1 -1
```

```

0148:l2[0,0] cache[0] miss
0148:file[0] fd[5] read, off 0x710 len 2048
0148:file[0] cache[0] l2[0] read offset 0x710
0148:file[0] l2[0,0] trk[0] read_l2ent 0xf10 3057 3057
0148:file[0] fd[5] read, off 0xf10 len 3057
0148:0 rdtrk[0] 0 complete buf 00DA4FB0:0100000000
0148:uncompress comp 1 len 3057 maxlen 56832 trk 0
0148:newbuf malloc 00DBCED8 len 56832
0148:uncompress zlib newlen 6491 rc 0
0148:validating trk 0 len 6491 0000000000 0000000000000008
0148:read trk 0 uncompressed len 6491
0148:HHCDA041I read count orientation is index
0148:HHCDA043I cyl 0 head 0 record 0 kl 0 dl 8 of 0
0148:HHCDA043I cyl 0 head 0 record 1 kl 4 dl 24 of 0
0148:HHCDA045I read data 24 bytes
HHCCP075I 0148:Stat=0C00 Count=0000 =>00080000 8000015A 06004A98 60000060 .....!...q...-
HHCCP048I 0148:CCW=06004A98 60000060=>00000000 00000000 00000000 00000000 .....
0148:HHCDA041I read count orientation is data
0148:HHCDA043I cyl 0 head 0 record 2 kl 4 dl 144 of 0
0148:HHCDA045I read data 144 bytes
HHCCP075I 0148:Stat=0C00 Count=0000 =>07004AB8 40000006 31004ABE 40000005 ....
HHCCP048I 0148:CCW=08004A98 00000000=>07004AB8 40000006 31004ABE 40000005 ....
HHCCP048I 0148:CCW=07004AB8 40000006=>00000000 00000000 00000400 00000000 .....
0148:HHCDA038I seeking to cyl 0 head 0
HHCCP075I 0148:Stat=0C00 Count=0000
HHCCP048I 0148:CCW=31004ABE 40000005=>00000000 04000000 00000000 00000000 .....
0148:HHCDA041I read count orientation is index
0148:HHCDA043I cyl 0 head 0 record 0 kl 0 dl 8 of 0
HHCCP075I 0148:Stat=0C00 Count=0000
HHCCP048I 0148:CCW=08004AA0 00000000=>31004ABE 40000005 08004AA0 00000000 ....
HHCCP048I 0148:CCW=31004ABE 40000005=>00000000 04000000 00000000 00000000 .....
0148:HHCDA041I read count orientation is count
0148:HHCDA043I cyl 0 head 0 record 1 kl 4 dl 24 of 0
HHCCP075I 0148:Stat=0C00 Count=0000
HHCCP048I 0148:CCW=08004AA0 00000000=>31004ABE 40000005 08004AA0 00000000 ....
HHCCP048I 0148:CCW=31004ABE 40000005=>00000000 04000000 00000000 00000000 .....
0148:HHCDA041I read count orientation is count
0148:HHCDA043I cyl 0 head 0 record 2 kl 4 dl 144 of 0
HHCCP075I 0148:Stat=0C00 Count=0000
HHCCP048I 0148:CCW=08004AA0 00000000=>31004ABE 40000005 08004AA0 00000000 ....
HHCCP048I 0148:CCW=31004ABE 40000005=>00000000 04000000 00000000 00000000 .....
0148:HHCDA041I read count orientation is count
0148:HHCDA043I cyl 0 head 0 record 3 kl 4 dl 80 of 0
HHCCP075I 0148:Stat=0C00 Count=0000
HHCCP048I 0148:CCW=08004AA0 00000000=>31004ABE 40000005 08004AA0 00000000 ....
HHCCP048I 0148:CCW=31004ABE 40000005=>00000000 04000000 00000000 00000000 .....
.
.
.

```

Figure 141: S+ dev command

Example 2:

Turn off CCW stepping.

```
2007/06/30 12:40:00.328 00000FC4 s- 0148  
2007/06/30 12:40:00.328 00000FC4 HHCPN137I CCW stepping is now off for device 0148
```

Figure 142: S- dev command

7.89 SAVECORE (Save a core image to a file)

7.89.1 Function

The SAVECORE command allows you to save a a portion of real storage in binary form to a file. This command is used mainly for emulator debugging purposes. A certain core snapshot can be saved and then be restored at any later time to reproduce some tests with identical real storage values.

Please note that you have to stop all CPUs (see STOP/STOPALL commands) before saving the core image to a file.

7.89.2 Syntax

Descriptive

```
SAVECORE filename [start | * ] [end | * ]
```

Diagram

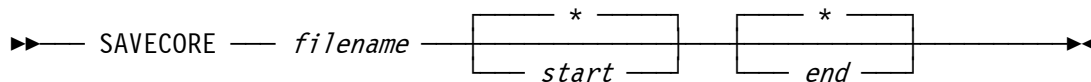

7.89.3 Parameter

- filename** This argument specifies the file name (and optionally the path) of the file where the core image will be written to.
- start | *** Start specifies the start address of the real storage to be saved to the file *filename*. The asterisk ("*"), the default, means the first byte of the first modified page as determined by the storage-key changed bit.
- end | *** End specifies the end address of the real storage to be saved to the file *filename*. The asterisk ("*"), the default, means the last byte of the last modified page as determined by the storage-key changed bit.

7.89.4 Examples

Example 1:

Save the first 4096 bytes of real storage to file D:\core01.bin.

```
2007/06/30 09:50:40.156 0000008E stopall
2007/06/30 09:50:44.390 0000008E savecore d:\core01.bin 00000000 00001000
2007/06/30 09:50:44.390 0000008E HHCPN104I Saving locations 00000000-00001000 to d:\core01.bin
2007/06/30 09:50:44.406 0000008E HHCPN170I savecore command complete.
```

Figure 143: SAVECORE command (save specific area)

Example 2:

Save all real storage to file D:\core02.bin.

```
2007/06/30 09:51:10.156 0000008E stopall
2007/06/30 09:51:22.640 0000008E savecore d:\core02.bin * *
2007/06/30 09:51:22.640 0000008E HHCPN104I Saving locations 00000000-0FFFFFFF to d:\core02.bin
2007/06/30 09:51:29.500 0000008E HHCPN170I savecore command complete.
```

Figure 144: SAVECORE command (save from begin to end)

7.90 SCLPROOT (Set or display SCLP base directory)

7.90.1 Function

The SCLPROOT command sets or displays the SCLP base directory. If a directory is given then SCLP disk I/O for the specified directory path is enabled. NONE disables SCLP disk I/O.

A subsequent list-directed IPL resets the path to the location of the .ins file, and a subsequent CCW-type IPL disables SCLP disk I/O. If no operand is specified, SCLPROOT displays the current setting.

7.90.2 Syntax

Descriptive

```
SCLPROOT [NONE | directory]
```

Diagram

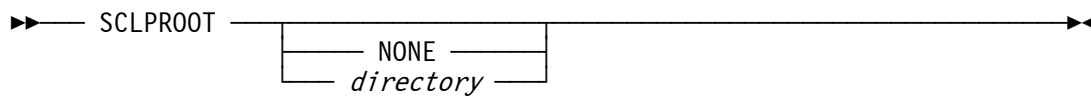

7.90.3 Parameter

NONE Disables SCLP disk I/O.

directory Specifies the directory from which SCLP disk I/O is allowed. A subsequent IPL of an .ins file or a subsequent CCW-type IPL will override this.

7.90.4 Examples

Example 1:

Display SCLP base directory.

```
2009/03/07 21:30:15.796 00000D80 sclproot  
2009/03/07 21:30:15.796 00000D80 SCLP DISK I/O Disabled
```

Figure 145: SCLPROOT command (display directory)

Example 2:

Set SCLP base directory.

```
2009/03/07 21:30:27.109 00000D80 sclproot D:/ISO
```

Figure 146: SCLPROOT command (set directory)

7.91 SCP (Send system control program command)

7.91.1 Function

The SCP command sends a command to the system control program (i.e. the guest operating system running under Hercules) in any CMDTGT mode.

7.91.2 Syntax

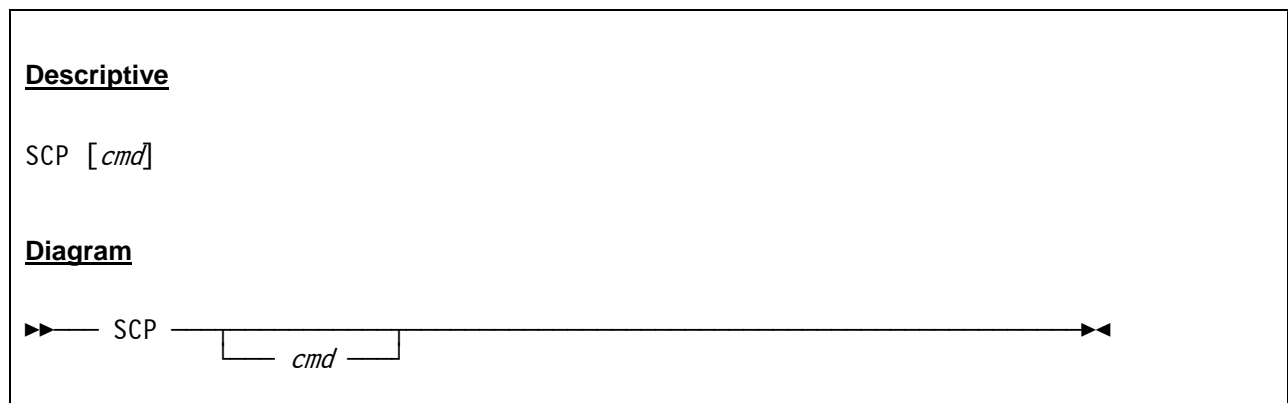

7.91.3 Parameter

cmd This is the command to be sent to the system control program (the guest operating system).

7.91.4 Examples

Example 1:

Send a command to the system control program running under Hercules when in HERC or PSCP command target mode.

```
2008/08/30 09:09:04.406 00000FC4 * IGGN504A SPECIFY UNIT FOR CATALOG.MVS.MASTER ON MVSRES
2008/08/30 09:10:04.406 00000FC4 scp r 00,0148
2008/08/30 09:10:04.406 00000FC4 HHCCP041I SYSCONS interface active
2008/08/30 09:10:04.406 00000FC4 IEE600I REPLY TO 00 IS:0148
```

Figure 147: SCP command

7.92 SCRIPT (Run a sequence of commands contained in a file)

7.92.1 Function

The SCRIPT command sequentially executes the commands contained within the file *filename*. The script file itself may also contain script commands but the system ensures that no more than 10 levels of scripts are invoked at any one time to avoid recursion loops.

7.92.2 Syntax

Descriptive

```
SCRIPT filename [filename ... ]
```

Diagram

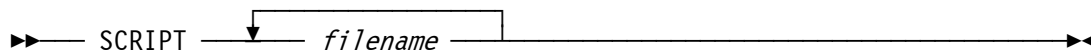

7.92.3 Parameter

filename The name (and optionally the path) of the script file to be executed.

7.92.4 Examples

Example 1:

Execute script "HERCULES.RC".

```
2007/06/30 13:10:53.125 00000FC4 script hercules.rc
2007/06/30 13:10:53.125 00000FC4 sh telnet localhost 3270
2007/06/30 13:10:53.140 00000FC4 ?
2007/06/30 13:10:53.140 00000FC4 HHCPN140I Valid panel commands are...
2007/06/30 13:10:53.140 00000FC4
2007/06/30 13:10:53.140 00000FC4 Command      Description...
2007/06/30 13:10:53.140 00000FC4 -----
2007/06/30 13:10:53.140 00000FC4 ?           list all commands
.
.
.
```

Figure 148: SCRIPT command

7.93 SCSI MOUNT (Automatic SCSI tape mounts)

7.93.1 Function

The SCSI MOUNT command displays or modifies the automatic SCSI tape mount option. When entered without any operands it displays the current value and any pending tape mount requests. Entering a value between 1 and 99 enables the option and specifies how often (in seconds) to query SCSI tape drives to automatically detect when a tape has been mounted. When a tape is mounted an unsolicited device attention interrupt will be presented to the guest operating system.

Notes: Enabling this option may negatively impact Hercules performance depending on how the host operating system (Windows, Linux, etc.) processes SCSI attached tape drive status queries. SCSI MOUNT is a synonym for the AUTO SCSI MOUNT command.

7.93.2 Syntax

Descriptive

SCSIMOUNT [NO | YES | *n*]

Diagram

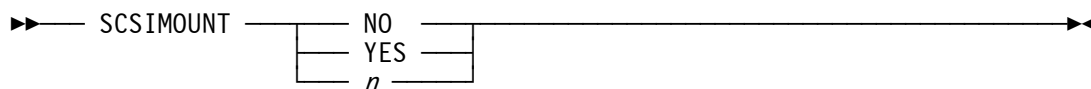

7.93.3 Parameter

- NO** No indicates that the SCSI MOUNT option is disabled forcing all SCSI tape mounts to be done manually via an appropriate DEVINIT command.
- YES** Yes enables the option and causes periodic queries of the SCSI tape drive in a five second interval to automatically detect when a tape is mounted. YES is equivalent with "SCSIMOUNT 5".
- n** A value from 1 to 99 seconds inclusive enables the option and causes periodic queries of the SCSI tape drive to automatically detect when a tape is mounted.

7.93.4 Examples

Example 1:

Enable the SCSIMOUNT option.

```
2007/06/30 10:57:06.296 00000FC4 scsimount 30
2007/06/30 10:57:06.296 00000FC4 SCSI auto-mount queries = every 30 seconds (when needed)
```

Figure 149: SCSIMOUNT command

7.94 SF+ (Create a new shadow file)

7.94.1 Function

With the SF+ command a new shadow file for a certain dasd device (or for all dasd devices that have shadow files) is created.

7.94.2 Syntax

Descriptive

SF+ {*device* | *}

Diagram

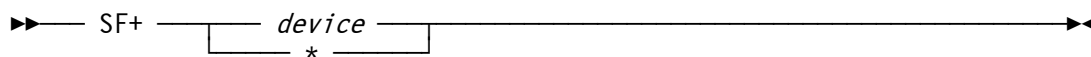

7.94.3 Parameter

- device** This specifies the device for which a new shadow file will be created.
- *** With an asterisk it is possible to create a (new) shadow file for all dasd devices that have a shadow file defined in their configuration file definition statements.

7.94.4 Examples

Example 1:

Create a new shadow file for device 0148.

```
00000FC4 sf+ 0148
00000FC4 HHCCD162I 0148 file[1] D:/MVS/DASD/MVSRES_1.148 added
00000FC4 HHCCD210I          size free  nbr st   reads  writes l2reads  hits switches
00000FC4 HHCCD212I -----
00000FC4 HHCCD213I [*]  324636047   6%   13         0         0         0         0         0
00000FC4 HHCCD215I D:/MVS/DASD/MVSRES.148
00000FC4 HHCCD216I [0]  324634239   6%   13 rd         0         0         0
00000FC4 HHCCD218I [1]    1808    0%    0 rw         0         0         0
```

Figure 150: SF+ command

7.95 SF- (Remove a shadow file)

7.95.1 Function

The SF- command removes a shadow file. Depending on the MERGE / NOMERGE / FORCE parameter the changes are incorporated in the base file or discarded.

If MERGE is specified or defaulted then the contents of the current file is merged into the previous file, the current file is removed and the previous file becomes the current file.

If NOMERGE is specified then the contents of the current file is discarded and the previous file becomes the current file. However if the previous file is read-only then a new shadow file is created ("re-added") and that becomes the current file.

The FORCE option is required when doing a merge to a base file and the base file is read-only because the 'ro' option was specified on the device configuration statement.

7.95.2 Syntax

Descriptive

SF- {*device* | *} [MERGE | NOMERGE | FORCE]

Diagram

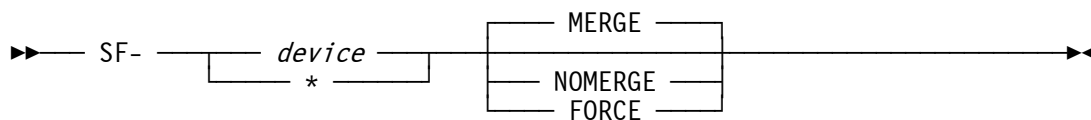

7.95.3 Parameter

- device** This specifies the device for which a shadow file should be deleted.
- *** With an asterisk it is possible to remove a shadow file for all dasd devices that have shadow files.
- MERGE** The MERGE parameter (which is the default) specifies that all changes or updates that have been made to the shadow file will be committed.
- NOMERGE** The NOMERGE parameter specifies that all changes or updates that have been made to the shadow file will be discarded instead of being committed.
- FORCE** The FORCE parameter is used when doing a merge to a base file that is read-only because the 'ro' option was specified on the device configuration statement.

7.95.4 Examples

Example 1:

Remove a shadow file with backwards merge (i.e. *commit* all of the changes/updates).

```
00000FC4 sf- 0148
00000FC4 HHCCD181I 0148 shadow file [1] successfully merged
00000FC4 HHCCD210I          size free  nbr st   reads  writes l2reads   hits switches
00000FC4 HHCCD211I          readaheads  misses
00000FC4 HHCCD212I -----
00000FC4 HHCCD213I [*] 324634239  6%  22      4296   1134    45   4395   7267
00000FC4 HHCCD214I          1426    126
00000FC4 HHCCD215I D:/MVS/DASD/MVSRES.148
00000FC4 HHCCD216I [0] 324634239  6%  22 rw   4053     0    45
00000FC4 HHCCD217I D:/MVS/DASD/MVSRES_*.148
```

Figure 151: SF- command

Example 2:

Remove a shadow file without backwards merge (i.e. *discard* all of the changes/updates).

```
00000FC4 sf- 0148 nomerge
00000FC4 HHCCD181I 0148 shadow file [1] successfully removed
00000FC4 HHCCD210I          size free  nbr st   reads  writes l2reads   hits switches
00000FC4 HHCCD211I          readaheads  misses
00000FC4 HHCCD212I -----
00000FC4 HHCCD213I [*] 324634239  6%  22      4329   1118    45   4376   7268
00000FC4 HHCCD214I          1440    140
00000FC4 HHCCD215I D:/MVS/DASD/MVSRES.148
00000FC4 HHCCD216I [0] 324634239  6%  22 rw   4061     0    45
00000FC4 HHCCD217I D:/MVS/DASD/MVSRES_*.148
```

Figure 152: SF- NOMERGE command

7.96 SFC (Compress a shadow file)

7.96.1 Function

The SFC command compresses a shadow file.

7.96.2 Syntax

Descriptive

SFC {*device* | *}

Diagram

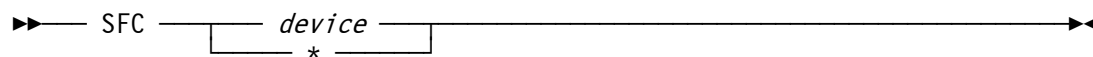

7.96.3 Parameter

- device** This specifies the device for which the shadow file will be compressed.
- *** With an asterisk it is possible to compress the shadow files for all dasd devices that have a shadow file.

7.96.4 Examples

Example 1:

Compress the shadow file for dasd device 0148.

```
00000FC4 sfc 0148
00000FC4 cckdcomp: completed: moves 1105 moved 23817149 freed 299782
00000FC4 HHCCD210I          size free  nbr st   reads  writes l2reads   hits switches
00000FC4 HHCCD211I                                     readaheads  misses
00000FC4 HHCCD212I -----
00000FC4 HHCCD213I [*]  348465484   6%   22     4329   1118     45   4376   7268
00000FC4 HHCCD214I                                     1440    140
00000FC4 HHCCD215I D:/MVS/DASD/MVSRES.148
00000FC4 HHCCD216I [0]  324634239   6%   22 rd    4061     0    45
00000FC4 HHCCD217I D:/MVS/DASD/MVSRES_*.148
00000FC4 HHCCD218I [1]  23831245    0%   0 rw     268   1118     0
```

Figure 153: SFC command

7.98 SFK (Perform a chkdsk on the active shadow file)

7.98.1 Function

The SFK command performs a chkdsk on the active shadow file(s).

7.98.2 Syntax

Descriptive

SFK { *device* | * } [*n*]

Diagram

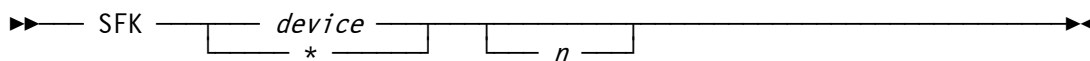

7.98.3 Parameter

- device** This specifies the device for which active shadow file a chkdsk is to be performed.
- *** With an asterisk it is possible to perform a chkdsk for the active shadow files of all dasd devices.
- n** The optional check level to be performed (default is 2):
- 1 devhdr, cdevhdr, l1 table
 - 0 devhdr, cdevhdr, l1 table, l2 tables
 - 1 devhdr, cdevhdr, l1 table, l2 tables, free spaces
 - 2 devhdr, cdevhdr, l1 table, l2 tables, free spaces, trkhdrs
 - 3 devhdr, cdevhdr, l1 table, l2 tables, free spaces, trkings
 - 4 devhdr, cdevhdr, build everything else from recovery

Use check level '4' only after making a backup and be prepared to wait a long time!

7.98.4 Examples

Example 1:

Perform chkdsk level '2' for the shadow file of dasd device 0AEO.

```
00000AEO sfk 0148
00000AEO HHCCD210I          size free  nbr st   reads  writes l2reads   hits switches
00000AEO HHCCD211I                                     readaheads  misses
00000AEO HHCCD212I -----
00000AEO HHCCD213I [*] 340102838  0%   0      8823   836    142  27681   33892
00000AEO HHCCD214I                                     2614    1191
00000AEO HHCCD215I D:/MVS/DASD/MVSRES.148
00000AEO HHCCD216I [0] 340048223  0%   0 rd   8570    0    137
00000AEO HHCCD217I D:/MVS/DASD/MVSRES*.148
00000AEO HHCCD218I [1]   54615  0%   0 rw    253   836    5
```

Figure 155: SFK command (chkdsk level 2)

Example 2:

Perform chkdsk level '4' for the shadow file of dasd device 0AEO.

```
00000AEO sfk 0AEO
00000AEO sfk 0148 4
00000AEO HHCCU301I 0AEO file[1]: trk[26309] recovered offset 0x2f10 len 57
00000AEO HHCCU301I 0AEO file[1]: trk[34077] recovered offset 0x2f49 len 125
00000AEO HHCCU301I 0AEO file[1]: trk[34047] recovered offset 0x2fc6 len 208
00000AEO HHCCU301I 0AEO file[1]: trk[34050] recovered offset 0x3096 len 104
00000AEO HHCCU301I 0AEO file[1]: trk[7] recovered offset 0x30fe len 924
00000AEO HHCCU301I 0AEO file[1]: trk[34079] recovered offset 0x349a len 210
00000AEO HHCCU301I 0AEO file[1]: trk[34048] recovered offset 0x356c len 769
00000AEO HHCCU301I 0AEO file[1]: trk[34081] recovered offset 0x386d len 142
00000AEO HHCCU301I 0AEO file[1]: trk[34080] recovered offset 0x38fb len 765
00000AEO HHCCU301I 0AEO file[1]: trk[34082] recovered offset 0x3bf8 len 105
00000AEO HHCCU301I 0AEO file[1]: trk[34078] recovered offset 0x3c61 len 349
00000AEO HHCCU301I 0AEO file[1]: trk[34045] recovered offset 0x3dbe len 125
00000AEO HHCCU301I 0AEO file[1]: trk[34046] recovered offset 0x3e3b len 349
00000AEO HHCCU301I 0AEO file[1]: trk[34075] recovered offset 0x3f98 len 279
00000AEO HHCCU301I 0AEO file[1]: trk[34084] recovered offset 0x40af len 341
00000AEO HHCCU301I 0AEO file[1]: trk[34085] recovered offset 0x4204 len 341
00000AEO HHCCU301I 0AEO file[1]: trk[34049] recovered offset 0x4359 len 143
00000AEO HHCCU301I 0AEO file[1]: trk[34083] recovered offset 0x43e8 len 631
00000AEO HHCCU301I 0AEO file[1]: trk[34086] recovered offset 0x465f len 340
00000AEO HHCCU301I 0AEO file[1]: trk[34088] recovered offset 0x47b3 len 339
00000AEO HHCCU301I 0AEO file[1]: trk[34103] recovered offset 0x4906 len 292
00000AEO HHCCU301I 0AEO file[1]: trk[34089] recovered offset 0x4a2a len 339
00000AEO HHCCU301I 0AEO file[1]: trk[34090] recovered offset 0x4b7d len 340
00000AEO HHCCU301I 0AEO file[1]: trk[31995] recovered offset 0x4cd1 len 3870
00000AEO HHCCU301I 0AEO file[1]: trk[34087] recovered offset 0x5bef len 340
00000AEO HHCCU301I 0AEO file[1]: trk[34091] recovered offset 0x5d43 len 340
00000AEO HHCCU301I 0AEO file[1]: trk[34092] recovered offset 0x5e97 len 340
00000AEO HHCCU301I 0AEO file[1]: trk[31999] recovered offset 0x5feb len 7932
00000AEO HHCCU301I 0AEO file[1]: trk[4] recovered offset 0x7ee7 len 1320
```

```

00000AE0 HHCCU301I OAE0 file[1]: trk[5] recovered offset 0x840f len 1526
00000AE0 HHCCU301I OAE0 file[1]: trk[3] recovered offset 0x8a05 len 1445
00000AE0 HHCCU301I OAE0 file[1]: trk[34093] recovered offset 0x8faa len 340
00000AE0 HHCCU301I OAE0 file[1]: trk[34094] recovered offset 0x90fe len 340
00000AE0 HHCCU301I OAE0 file[1]: trk[34095] recovered offset 0x9252 len 338
00000AE0 HHCCU301I OAE0 file[1]: trk[34096] recovered offset 0x93a4 len 339
00000AE0 HHCCU301I OAE0 file[1]: trk[34097] recovered offset 0x94f7 len 340
00000AE0 HHCCU301I OAE0 file[1]: trk[34098] recovered offset 0x964b len 340
.
several lines not displayed
.
00000AE0 HHCCU301I OAE0 file[1]: trk[34060] recovered offset 0xa9fd len 339
00000AE0 HHCCU301I OAE0 file[1]: trk[34061] recovered offset 0xab50 len 340
00000AE0 HHCCU301I OAE0 file[1]: trk[34062] recovered offset 0xaca4 len 340
00000AE0 HHCCU301I OAE0 file[1]: trk[34063] recovered offset 0xadf8 len 340
00000AE0 HHCCU301I OAE0 file[1]: trk[34064] recovered offset 0xaf4c len 340
00000AE0 HHCCU301I OAE0 file[1]: trk[34065] recovered offset 0xb0a0 len 338
00000AE0 HHCCU301I OAE0 file[1]: trk[34066] recovered offset 0xb1f2 len 338
00000AE0 HHCCU301I OAE0 file[1]: trk[34067] recovered offset 0xb344 len 340
00000AE0 HHCCU301I OAE0 file[1]: trk[34068] recovered offset 0xb498 len 340
00000AE0 HHCCU301I OAE0 file[1]: trk[34069] recovered offset 0xb5ec len 340
00000AE0 HHCCU301I OAE0 file[1]: trk[34070] recovered offset 0xb740 len 340
00000AE0 HHCCU301I OAE0 file[1]: trk[34071] recovered offset 0xb894 len 295
00000AE0 HHCCU301I OAE0 file[1]: trk[1] recovered offset 0xb9bb len 1570
00000AE0 HHCCU301I OAE0 file[1]: trk[34107] recovered offset 0xbfdd len 277
00000AE0 HHCCU301I OAE0 file[1]: trk[6] recovered offset 0xc0f2 len 796
00000AE0 HHCCU301I OAE0 file[1]: trk[34072] recovered offset 0xc40e len 349
00000AE0 HHCCU301I OAE0 file[1]: trk[34073] recovered offset 0xc56b len 338
00000AE0 HHCCU301I OAE0 file[1]: trk[34074] recovered offset 0xc6bd len 340
00000AE0 HHCCU301I OAE0 file[1]: trk[34104] recovered offset 0xc811 len 345
00000AE0 HHCCU301I OAE0 file[1]: trk[34105] recovered offset 0xc96a len 338
00000AE0 HHCCU301I OAE0 file[1]: trk[34106] recovered offset 0xcabc len 338
00000AE0 HHCCU301I OAE0 file[1]: trk[8] recovered offset 0xcc0e len 665
00000AE0 HHCCU301I OAE0 file[1]: trk[2] recovered offset 0xcea7 len 1712
00000AE0 HHCCU300I OAE0 file[1]: 73 trk images recovered
00000AE0 HHCCU104I OAE0 file[1]: free space rebuilt
00000AE0 HHCCD210I          size free  nbr st   reads  writes l2reads   hits switches
00000AE0 HHCCD211I                                readaheads  misses
00000AE0 HHCCD212I -----
00000AE0 HHCCD213I [*] 340102838  0%   0      8825   836    143   27681   33894
00000AE0 HHCCD214I                                2614    1191
00000AE0 HHCCD215I D:/MVS/DASD/MVSRES.148
00000AE0 HHCCD216I [0] 340048223  0%   0 rd   8572     0    138
00000AE0 HHCCD217I D:/MVS/DASD/MVSRES*.148
00000AE0 HHCCD218I [1]   54615  0%   0 rw    253   836     5

```

Figure 156: SFK command (chkdsk level 4)

```
2007/06/30 16:11:56.265 00000550 07.08.2006 17:59 <DIR> PRT
2007/06/30 16:11:56.265 00000550 07.08.2006 17:59 <DIR> SHADOW
2007/06/30 16:11:56.265 00000550 07.08.2006 17:59 <DIR> TAPE
2007/06/30 16:11:56.265 00000550 07.08.2006 17:59 <DIR> TN3270
2007/06/30 16:11:56.265 00000550 12.08.1994 12:23 8'480 SLEEP.EXE
2007/06/30 16:11:56.265 00000550 24.10.2005 07:57 633 MVS38J_GUI.BAT
2007/06/30 16:11:56.265 00000550 24.10.2005 08:23 632 MVS38J_NATIVE.BAT
2007/06/30 16:11:56.265 00000550 24.10.2005 08:18 1'053 MVS38J_TERMINAL.BAT
2007/06/30 16:11:56.265 00000550 4 File(s) 10'798 bytes
2007/06/30 16:11:56.265 00000550 12 Dir(s) 25'160'966'144 bytes free
2007/06/30 16:11:56.265 Command ended; rc=0
```

Figure 157: SH command

7.100 SHRD (SHRD command)

7.100.1 Function

The SHRD command has two functions. Depending on the given arguments it initializes the Shared Device Server trace table and starts the trace or it prints the contents of the current trace table.

7.100.2 Syntax

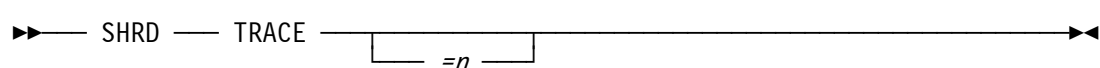
<p><u>Descriptive</u></p> <p>SHRD TRACE [=n]</p> <p><u>Diagram</u></p> 

7.100.3 Parameter

TRACE TRACE, when specified without a decimal number, prints the current contents of the trace table.

n This specifies the trace table size (decimal). If the TRACE argument is given with a number then a trace table with a size of *n* elements initialized.

7.100.4 Examples

Example 1:

Initialize the Shared Device Server trace table with a size of 2500 trace entries.

```
2007/08/25 17:36:48.153 00000190 shrd trace=2500
```

Figure 158: SHRD command (initialize trace table)

Example 2:

Print the Shared Device Server trace table.

```
2007/08/25 17:37:57.091 00000190 shrd trace
2007/08/25 17:37:58.091 00000190 1188056256.238492 0148:select rc 1
2007/08/25 17:37:58.106 00000190 1188056256.238502 0148:select isset 1048 id=1
2007/08/25 17:37:58.106 00000190 1188056256.238509 0148:select ready 1048 id=1
2007/08/25 17:37:58.106 00000190 1188056256.238519 0000:recvData e3 00 148 1 0
2007/08/25 17:37:58.106 00000190 1188056256.238524 0148:server_request [0] e3 00 148 1 0
2007/08/25 17:37:58.106 00000190 1188056256.238530 0148:server_request inactive id=1
2007/08/25 17:37:58.106 00000190 1188056256.238534 0148:server_send 00 00 148 1 0
2007/08/25 17:37:58.106 00000190 1188056256.238560 0148:select set 1048 id=1
2007/08/25 17:37:58.106 00000190 1188056256.238988 0148:select rc 1
2007/08/25 17:37:58.106 00000190 1188056256.238999 0148:select isset 1048 id=1
2007/08/25 17:37:58.106 00000190 1188056256.239006 0148:select ready 1048 id=1
2007/08/25 17:37:58.106 00000190 1188056256.239020 0000:recvData e2 00 148 1 0
2007/08/25 17:37:58.106 00000190 1188056256.239028 0148:server_request [0] e2 00 148 1 0
2007/08/25 17:37:58.106 00000190 1188056256.239035 0148:server_request active id=1
2007/08/25 17:37:58.106 00000190 1188056256.239041 0148:server_send 00 00 148 1 0
2007/08/25 17:37:58.106 00000190 1188056256.239075 0148:select set 1048 id=1
2007/08/25 17:37:58.106 00000190 1188056256.239243 0148:select rc 1
2007/08/25 17:37:58.106 00000190 1188056256.239252 0148:select isset 1048 id=1
2007/08/25 17:37:58.106 00000190 1188056256.239260 0148:select ready 1048 id=1
2007/08/25 17:37:58.106 00000190 1188056256.239270 0000:recvData e8 00 148 1 4
2007/08/25 17:37:58.106 00000190 1188056256.239278 0148:server_request [0] e8 00 148 1 4
.
several lines not displyed
.
2007/08/25 17:37:58.356 00000190 1188056256.591571 0148:server_request inactive id=1
2007/08/25 17:37:58.356 00000190 1188056256.591579 0148:server_send 00 00 148 1 0
2007/08/25 17:37:58.356 00000190 1188056256.591630 0148:select set 1048 id=1
2007/08/25 17:37:58.356 00000190 1188056259.840521 0340:select rc 0
2007/08/25 17:37:58.356 00000190 1188056259.840537 0340:select set 1020 id=1
2007/08/25 17:37:58.356 00000190 1188056259.840538 0341:select rc 0
2007/08/25 17:37:58.356 00000190 1188056259.840547 0341:select set 992 id=1
2007/08/25 17:37:58.356 00000190 1188056259.840563 0342:select rc 0
2007/08/25 17:37:58.356 00000190 1188056259.840569 0343:select rc 0
2007/08/25 17:37:58.356 00000190 1188056259.840572 0342:select set 964 id=1
2007/08/25 17:37:58.356 00000190 1188056259.840579 0343:select set 936 id=1
2007/08/25 17:37:58.356 00000190 1188056266.591236 0148:select rc 0
2007/08/25 17:37:58.356 00000190 1188056266.591253 0148:select set 1048 id=1
2007/08/25 17:37:58.356 00000190 1188056269.841130 0340:select rc 0
2007/08/25 17:37:58.356 00000190 1188056269.841149 0340:select set 1020 id=1
2007/08/25 17:37:58.356 00000190 1188056269.841177 0342:select rc 0
2007/08/25 17:37:58.356 00000190 1188056269.841186 0342:select set 964 id=1
2007/08/25 17:37:58.356 00000190 1188056269.841187 0341:select rc 0
2007/08/25 17:37:58.356 00000190 1188056269.841197 0341:select set 992 id=1
2007/08/25 17:37:58.356 00000190 1188056269.841220 0343:select rc 0
2007/08/25 17:37:58.356 00000190 1188056269.841229 0343:select set 936 id=1
2007/08/25 17:37:58.356 00000190 1188056276.590940 0148:select rc 0
2007/08/25 17:37:58.356 00000190 1188056276.590957 0148:select set 1048 id=1
```

Figure 159: SHRD command (print trace table)

7.101 SIZEOF (Display size of structures)

7.101.1 Function

The SIZEOF command shows the size of various Hercules internal structures.

7.101.2 Syntax

Descriptive

SIZEOF

Diagram

▶— SIZEOF —————▶

7.101.3 Parameter

None.

7.101.4 Examples

Example 1:

Display the size of structures.

```
2009/02/07 18:41:40.191 00000830 sizeof
2009/02/07 18:41:40.191 00000830 HHCPN161I (void *) ..... 4
2009/02/07 18:41:40.191 00000830 HHCPN161I (unsigned int) .... 4
2009/02/07 18:41:40.191 00000830 HHCPN161I (long) ..... 4
2009/02/07 18:41:40.191 00000830 HHCPN161I (long long) ..... 8
2009/02/07 18:41:40.191 00000830 HHCPN161I (size_t) ..... 4
2009/02/07 18:41:40.191 00000830 HHCPN161I (off_t) ..... 8
2009/02/07 18:41:40.191 00000830 HHCPN161I SYSBLK ..... 42848
2009/02/07 18:41:40.191 00000830 HHCPN161I REGS ..... 41624
2009/02/07 18:41:40.191 00000830 HHCPN161I REGS (copy len) ... 1480
2009/02/07 18:41:40.191 00000830 HHCPN161I PSW ..... 40
2009/02/07 18:41:40.191 00000830 HHCPN161I DEVBLK ..... 1816
2009/02/07 18:41:40.191 00000830 HHCPN161I TLB entry ..... 36
2009/02/07 18:41:40.191 00000830 HHCPN161I TLB table ..... 36864
2009/02/07 18:41:40.191 00000830 HHCPN161I FILENAME_MAX ..... 260
2009/02/07 18:41:40.191 00000830 HHCPN161I PATH_MAX ..... 260
```

Figure 160: SIZEOF command

7.102 SSD (Signal shutdown)

7.102.1 Function

The SSD (signal shutdown) command signals an imminent hypervisor shutdown to the guest. Guests who support this are supposed to perform a shutdown upon receiving this request.

An implicit `ssd` command is given on a `hercules QUIT` command if the guest supports `ssd`. In that case the Hercules shutdown will be delayed until the guest has shutdown or a second `quit` command is given.

7.102.2 Syntax

Descriptive

SSD

Diagram

▶▶ — SSD —————▶▶

7.102.3 Parameter

None.

7.102.4 Examples

Example 1:

Signal an imminent hypervisor shutdown to the guest operating system. In this example the guest operating system does not support this function.

```
2007/08/25 18:18:40.294 000004B8 ssd
2007/08/25 18:18:40.294 000004B8 HHCCP081E SCP not receiving quiesce signals
```

Figure 161: SSD command

7.103 START (Start CPU or printer device)

7.103.1 Function

The START command by itself (without argument) simply starts a stopped CPU, whereas START *devicenum* presses the (virtual) start button on printer device *devicenum*.

7.103.2 Syntax

Descriptive

START [*devicenum*]

Diagram

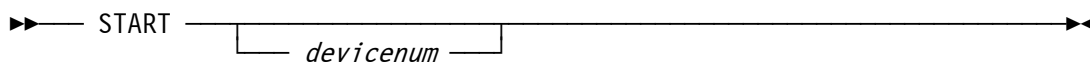

7.103.3 Parameter

devicenum The device number of the printer which should be started.

7.103.4 Examples

Example 1:

Start the printer device 000E.

```
2007/06/30 10:07:43.296 00000FC4 start 000e
2007/06/30 10:07:43.296 00000FC4 HHCPN018I Printer 000E starter
```

Figure 162: START command (start printer)

Example 2:

Start CPU 1.

```
2007/06/30 10:09:23.148 00000FC4 cpu 1
2007/06/30 10:09:23.148 00000FC4 start
```

Figure 163: START command (start CPU)

7.104 STARTALL (Start all CPUs)

7.104.1 Function

The STARTALL command starts all CPUs.

7.104.2 Syntax

Descriptive

STARTALL

Diagram

▶— STARTALL —————▶

7.104.3 Parameter

None.

7.104.4 Examples

Example 1:

Start all CPU's.

```
00000FC4 startall
00000FC4 HHCCP014I CPU0001: Operation exception CODE=0001 ILC=2
00000FC4 CPU0001: PSW=00000000 00000000 INST=000A      ?????
00000FC4 CPU0001: GR00=00000000 GR01=00000000 GR02=00000000 GR03=00000000
00000FC4 CPU0001: GR04=00000000 GR05=00000000 GR06=00000000 GR07=00000000
00000FC4 CPU0001: GR08=00000000 GR09=00000000 GR10=00000000 GR11=00000000
00000FC4 CPU0001: GR12=00000000 GR13=00000000 GR14=00000000 GR15=00000000
00000FC4 HHCCP014I CPU0001: Addressing exception CODE=0005 ILC=6
00000FC4 CPU0001: PSW=00080000 80000A1A INST=D50106401000 CLC 1600(2,0),0(1)
00000FC4 CPU0001: R:00000640:K:06=B22C0005 A774FFFC 50405000 184518F5 ...x...& &....5
00000FC4 CPU0001: R:7FFFFFFE: Translation exception 0005
00000FC4 CPU0001: GR00=00000000 GR01=FFFFFFFE GR02=00000000 GR03=00000000
00000FC4 CPU0001: GR04=00000000 GR05=00000000 GR06=00000000 GR07=00000000
00000FC4 CPU0001: GR08=00000000 GR09=00000000 GR10=00000000 GR11=00000000
00000FC4 CPU0001: GR12=00000000 GR13=00000000 GR14=00000000 GR15=00000000
00000FC4 HHCCP011I CPU0001: Disabled wait state
00000FC4 PSW=000A0000 00000019
```

Figure 164: STARTALL command

7.105 STOP (Stop CPU or printer device)

7.105.1 Function

The STOP command by itself (without argument) simply stops a started CPU, whereas STOP *devicenum* presses the (virtual) stop button on printer device *devicenum*

7.105.2 Syntax

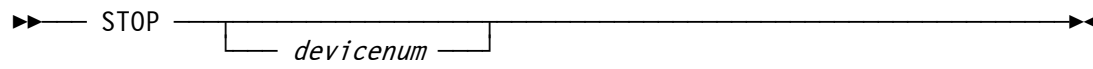
<p><u>Descriptive</u></p> <p>STOP [<i>devicenum</i>]</p> <p><u>Diagram</u></p> 
--

7.105.3 Parameter

devicenum The device number of the printer which has to be stopped.

7.105.4 Examples

Example 1:

Stop the printer device 000E.

```
2007/06/30 10:07:39.312 00000FC4 stop 000e
2007/06/30 10:07:39.312 00000FC4 HHCPN025I Printer 000E stopped
```

Figure 165: STOP command (stop printer)

Example 2:

Stop CPU 1.

```
2007/06/30 10:09:23.148 00000FC4 cpu 1
2007/06/30 10:09:23.148 00000FC4 stop
```

Figure 166: STOP command (stop CPU)

7.106 STOPALL (Stop all CPUs)

7.106.1 Function

The STOPALL command stops all CPUs

7.106.2 Syntax

Descriptive

STOPALL

Diagram

▶— STOPALL —————▶

7.106.3 Parameter

None.

7.106.4 Examples

Example 1:

Stop all CPU's.

```
2007/06/30 14:26:19.137 00000FC4 stopall
```

Figure 167: STOPALL command

7.107 STORE (Store CPU status at absolute zero)

7.107.1 Function

The STORE command stores the CPU status of the active CPU at absolute zero.

7.107.2 Syntax

Descriptive

STORE

Diagram

▶— STORE —————▶

7.107.3 Parameter

None.

7.107.4 Examples

Example 1:

Store status for active CPU.

```
2007/06/30 15:31:05.968 00000FC4 store
2007/06/30 15:31:05.968 00000FC4 HHCCP010I CPU0000 store status completed.
```

Figure 168: STORE command

7.108 SUSPEND (Suspend Hercules)

7.108.1 Function

This command lets you suspend the current Hercules session and shutdown the host machine. Subsequently the suspended session can be resumed (see “RESUME” command). The data necessary to be saved for a later restart is saved in a packed (zipped) file called “hercules.srf.gz” which is located in the current configuration path.

After entering the SUSPEND command the CPUs are put in a stopped state and the contents of the main storage, CPU states, I/O device states and internal Hercules states are dumped onto the “Hercules.srf.gz” file. After the SUSPEND command has finished writing to the suspend file, it schedules an immediate shutdown of Hercules.

Currently device state is only fully saved for CKD disks. Each device class (e.g. TAPE, RDR, PUN, CTC) will need code to save and restore their state. Some states may not be possible to restore (e.g. active TCP/IP connections at the time of suspend). Currently the vector facility state is not saved, neither is the ECPSVM state.

The created suspend file is designed to be HERCULES release independent and to be host architecture independent. For example it is possible to take a suspend file created on HERCULES 3.05.0 on an Intel machine and resume on a Sun machine running HERCULES 3.07.0.

Please note that there are some caveats with suspend / resume processing which can affect the guest operating system running under Hercules. These caveats are described in the chapter about RESUME processing (**Fehler! Verweisquelle konnte nicht gefunden werden.**, RESUME).

There are some caveats when suspending and resuming guest operating system processing:

- As seen by the guest operating system, the TOD clock will appear to jump a large value. Some guests may not cope very well with this. For example some guests may be dismayed because certain interrupts will occur way past its due time. Also for S/370 an interval timer interrupt may be lost if the guest is interrupted for more than half the Interval Timer wrap time (around 8 hours).
- Although some effort has been put in order to make this as transparent as possible (that is, it should appear to the guest operating system that the STOP key was pressed for a large amount of time), some state information may be missed.

Some guest operating systems will fare better if the suspend state is prepared first. For MVS, as an example, it seems to help when a QUIESCE command and a SYSTEM RESTART manual operation are issued prior to suspend the system.

7.108.2 Syntax

Descriptive

SUSPEND

Diagram

▶▶ — SUSPEND —————▶▶

7.108.3 Parameter

None.

7.108.4 Examples

Example 1:

Suspend the Hercules session.

```
2007/06/30 14:15:41.328 00000FC4 suspend
2007/06/30 14:15:49.265 00000FC4 HHCIN900I Begin Hercules shutdown
2007/06/30 14:15:49.265 00000FC4 HHCIN901I Releasing configuration
2007/06/30 14:15:49.265 00000FC4 HHCCP008I CPU0001 thread ended: tid=00000F44, pid=1112
2007/06/30 14:15:49.265 00000458 HHCCP008I CPU0001 thread ended: tid=00000F44, pid=1112
```

Figure 169: SUSPEND command

7.109 SYNCIO (Display SYNCIO device statistics)

7.109.1 Function

This command shows the SYNCIO device statistics for all DASD devices.

7.109.2 Syntax

Descriptive

SYNCIO

Diagram

▶— SYNCIO —————▶

7.109.3 Parameter

None.

7.109.4 Examples

Example 1:

Display SYNCIO device statistics.

```
14:33:16.700 00000FC4 syncio
14:33:16.700 00000FC4 HHCPN072I 0130 synchronous:      397 asynchronous:      64
14:33:16.700 00000FC4 HHCPN072I 0131 synchronous:       11 asynchronous:       2
14:33:16.700 00000FC4 HHCPN072I 0132 synchronous:        7 asynchronous:        1
14:33:16.700 00000FC4 HHCPN072I 0133 synchronous:      134 asynchronous:      52
.
several lines not displayed
.
14:33:16.716 00000FC4 HHCPN072I 014B synchronous:        7 asynchronous:        1
14:33:16.716 00000FC4 HHCPN072I 014C synchronous:        7 asynchronous:        1
14:33:16.716 00000FC4 HHCPN072I 0160 synchronous:    2326 asynchronous:    629
14:33:16.716 00000FC4 HHCPN072I 0161 synchronous:       44 asynchronous:       19
14:33:16.716 00000FC4 HHCPN074I TOTAL synchronous:   57957 asynchronous:   9267   86%
```

Figure 170: SYNCIO command

7.110 SYSCLEAR (Issue SYSTEM CLEAR RESET manual operation)

7.110.1 Function

The SYSCLEAR command issues a SYSTEM CLEAR RESET manual operation. This is basically the same as the SYSRESET command (see below), but also clears main storage to x'00'. Additionally the general purpose registers, control registers, etc. are reset to their initial value. At this point the system is essentially in the same state as it was just after having been started.

Please note that all CPUs must be stopped prior to issuing a system clear reset or the function will be rejected with message HHCPN053E.

7.110.2 Syntax

Descriptive

SYSCLEAR

Diagram

▶▶ — SYSCLEAR —————▶▶

7.110.3 Parameter

None.

7.110.4 Examples

Example 1:

CLEAR RESET the system.

```
2007/06/30 14:15:41.328 00000FC4 stopall
2007/06/30 14:15:51.221 00000FC4 sysclear
```

Figure 171: SYSCLEAR command

7.111 SYSRESET (Issue SYSTEM RESET manual operation)

7.111.1 Function

The SYSRESET command issues a SYSTEM RESET manual operation. A CPU and I/O subsystem reset are performed.

Please note that all CPUs must be stopped prior to issuing a system reset or the function will be rejected with message HHCPN053E.

7.111.2 Syntax

Descriptive

SYSRESET

Diagram

▶▶ — SYSRESET —————▶▶

7.111.3 Parameter

None.

7.111.4 Examples

Example 1:

RESET the system.

```
2007/06/30 14:16:42.228 00000FC4 stopall
2007/06/30 14:17:03.421 00000FC4 sysreset
```

Figure 172: SYSRESET command

7.112 T (Instruction trace)

7.112.1 Function

This command sets the instruction tracing range. Instruction tracing is totally separate from the instruction stepping and breaking range. With or without a range the T command displays whether tracing is on or off and the range, if any.

The T command by itself does not activate instruction tracing. Use the T+ command to activate instruction tracing. The command "T 0" eliminates the range (all addresses will be traced).

7.112.2 Syntax

Descriptive

T [*addr-addr* | *addr:addr* | *addr.length* | 0]

Diagram

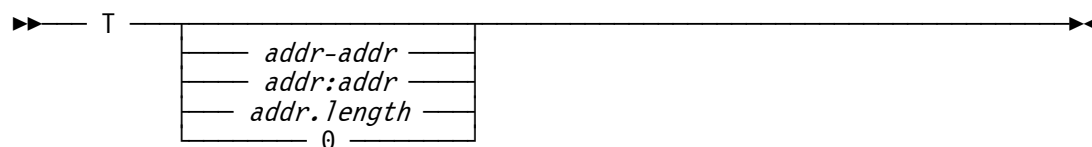

7.112.3 Parameter

- addr** Specifies an address. The range can be coded as "addr-addr" or "addr:addr" (from begin address to end address) or as *addr.length* (from begin address for length).
- length** Specifies the length of the range.
- 0** No range is specified or an existing range is reset. Tracing is active for all addresses.

7.112.4 Examples

Example 1:

Set instruction tracing range.

```
2009/02/15 10:06:22.432 00000FC4 t 1048576-1056768
2009/02/15 10:06:22.432 00000FC4 HHCPN040I Instruction tracing off range 1048576-1056768
```

Figure 173: T command

7.113 T+ (Instruction trace on)

7.113.1 Function

This command turns on instruction tracing. A range can be specified as for the T command. Instruction tracing is totally separate from the instruction stepping and breaking range.

After turning instruction tracing on, every instruction is listed with detailed trace information. The trace information includes the executing CPU, the PSW, the executed instruction in hexadecimal and in disassembled form as well as register hexadecimal displays of all involved register types.

This function is similar to the instruction stepping. The difference between these two function is that with instruction stepping the execution of every instruction has to be initiated by hitting ENTER on the Hercules console, whereas instruction tracing – once started – traces the instructions without interruption.

Please note that this function will create an enormous amount of output in the Hercules log. Running it on a relatively current machine (3 GHz HT Processor) for 10 seconds creates more than 10 MB of trace data.

7.113.2 Syntax

Descriptive

T+ [*addr-addr* | *addr:addr* | *addr.length* | 0]

Diagram

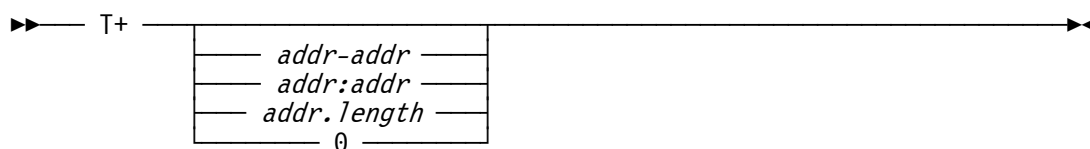

7.113.3 Parameter

- addr** Specifies an address. The range can be coded as “addr–addr” or “addr:addr” (from begin address to end address) or as *addr.length* (from begin address for length).
- length** Specifies the length of the range.
- 0** No range is specified or an existing range is reset. Tracing is active for all addresses.

7.113.4 Examples

Example 1:

Turn instruction tracing on.

```
t+
HHCPN040I Instruction tracing on
CPU0000: PSW=00080000 8000064C INST=50405000 ST 4,0(0,5) store
CPU0000: R:00002000:K:04=00000000 00000000 00000000 00000000 .....
CPU0000: GR00=00000000 GR01=00000000 GR02=00000000 GR03=00000032
CPU0000: GR04=00000000 GR05=00002000 GR06=00000000 GR07=00000000
CPU0000: GR08=00000000 GR09=00000000 GR10=00000000 GR11=00000000
CPU0000: GR12=00000000 GR13=00000000 GR14=00000000 GR15=00000000
CPU0000: PSW=00080000 80000650 INST=1845 LR 4,5 load_register
CPU0000: GR00=00000000 GR01=00000000 GR02=00000000 GR03=00000032
CPU0000: GR04=00000000 GR05=00002000 GR06=00000000 GR07=00000000
CPU0000: GR08=00000000 GR09=00000000 GR10=00000000 GR11=00000000
CPU0000: GR12=00000000 GR13=00000000 GR14=00000000 GR15=00000000
CPU0000: PSW=00080000 80000652 INST=18F5 LR 15,5 load_register
CPU0000: GR00=00000000 GR01=00000000 GR02=00000000 GR03=00000032
CPU0000: GR04=00002000 GR05=00002000 GR06=00000000 GR07=00000000
CPU0000: GR08=00000000 GR09=00000000 GR10=00000000 GR11=00000000
CPU0000: GR12=00000000 GR13=00000000 GR14=00000000 GR15=00000000
CPU0000: PSW=00080000 8000065C INST=50400010 ST 4,16(0,0) store
CPU0000: R:00000010:K:04=00000000 00000390 00000000 00000000 .....
CPU0000: GR00=00000000 GR01=00000000 GR02=00000000 GR03=00000000
CPU0000: GR04=00033000 GR05=00033000 GR06=00000000 GR07=00000000
CPU0000: GR08=00000000 GR09=00000000 GR10=00000000 GR11=00000000
CPU0000: GR12=00000000 GR13=00000000 GR14=00000000 GR15=00033000
CPU0000: PSW=00080000 80000660 INST=50400528 ST 4,1320(0,0) store
CPU0000: R:00000528:K:06=00000000 40000009 D840E5C3 D4D340D9 .... ..Q VCML R
CPU0000: GR00=00000000 GR01=00000000 GR02=00000000 GR03=00000000
CPU0000: GR04=00033000 GR05=00033000 GR06=00000000 GR07=00000000
CPU0000: GR08=00000000 GR09=00000000 GR10=00000000 GR11=00000000
CPU0000: GR12=00000000 GR13=00000000 GR14=00000000 GR15=00033000
CPU0000: PSW=00080000 80000664 INST=58200010 L 2,16(0,0) load
CPU0000: R:00000010:K:06=00033000 00000390 00000000 00000000 .....
CPU0000: GR00=00000000 GR01=00000000 GR02=00000000 GR03=00000000
CPU0000: GR04=00033000 GR05=00033000 GR06=00000000 GR07=00000000
CPU0000: GR08=00000000 GR09=00000000 GR10=00000000 GR11=00000000
CPU0000: GR12=00000000 GR13=00000000 GR14=00000000 GR15=00033000
.
.
.
```

Figure 174: T+ command

7.114 T- (Instruction trace off)

7.114.1 Function

This command turns off the instruction tracing function.

7.114.2 Syntax

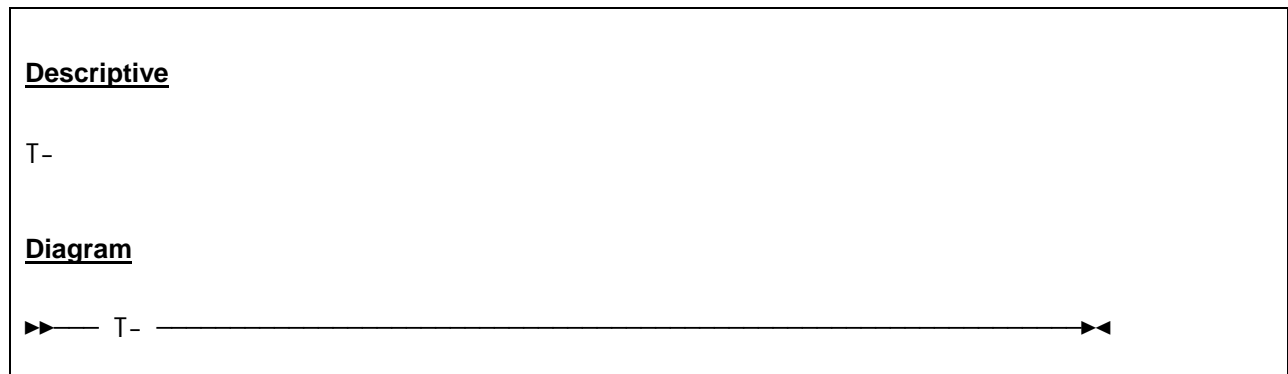

7.114.3 Parameter

None.

7.114.4 Examples

Example 1:

Turn off instruction tracing.

```
2009/02/15 10:07:39.312 00000FC4 t-  
2009/02/15 10:07:39.312 00000FC4 HHCPN040I Instruction tracing off range 1048576-1056768
```

Figure 175: T- command

7.115 T? (Instruction trace query)

7.115.1 Function

The T? command displays whether instruction tracing is on or off and the range if any.

7.115.2 Syntax

Descriptive

T?

Diagram

▶▶ — T? ————— ▶▶

7.115.3 Parameter

None.

7.115.4 Examples

Example 1:

Query instruction tracing.

```
2009/02/15 10:08:05.112 00000FC4 t?  
2009/02/15 10:08:05.112 00000FC4 HHCPN040I Instruction tracing on range 1048576-1056768
```

Figure 176: T? command

7.116 T{+/-} CKD (Turn CKD_KEY tracing on or off)

7.116.1 Function

The T{+/-}CKD command turns the CKD key tracing on (T+CKD) or turns it off (T-CKD).

7.116.2 Syntax

Descriptive

T{+ | -}CKD

Diagram

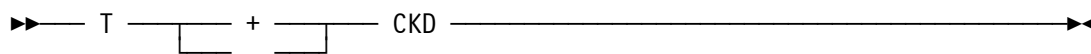

7.116.3 Parameter

- T+CKD** The T+CKD turns on the CKD key trace. The plus sign and the CKD argument must immediately follow the T command (without an intervening blank).
- T-CKD** The T-CKD turns off the CKD key trace. The minus sign and the CKD argument must immediately follow the T command (without an intervening blank).

7.116.4 Examples

Example 1:

Turning the CKD key trace on.

```
2007/06/01 05:52:41.290 0000C24 t+ckd
2007/06/01 05:53:02.634 0000C24 HHCDA055I search key SYS1.NUCLEUS
2007/06/01 05:53:02.650 0000C24 HHCDA055I search key IEANUC01
2007/06/01 05:53:02.775 0000C24 HHCDA055I search key IEAVNIPM
2007/06/01 05:53:02.775 0000C24 HHCDA055I search key IEAVNPA2
2007/06/01 05:53:02.822 0000C24 HHCDA055I search key IEAVNP01
2007/06/01 05:53:23.025 0000C24 HHCDA055I search key IEAVNPB2
2007/06/01 05:53:23.134 0000C24 HHCDA055I search key SYS1.LOGREC
2007/06/01 05:53:23.134 0000C24 HHCDA055I search key SYS1.SVCLIB
2007/06/01 05:53:23.134 0000C24 HHCDA055I search key IEAVNP11
2007/06/01 05:53:23.134 0000C24 HHCDA055I search key SYSCATLG
2007/06/01 05:53:23.134 0000C24 HHCDA055I search key Z9999994.VSAMDSPC
2007/06/01 05:53:23.150 0000C24 HHCDA055I search key IEAVNP1A
2007/06/01 05:53:23.165 0000C24 HHCDA055I search key IEAVNP03
2007/06/01 05:53:23.165 0000C24 HHCDA055I search key IEAVNP12
```

```

2007/06/01 05:53:23.165 00000C24 HHCDA055I search key SYS1.PARMLIB
2007/06/01 05:53:23.181 00000C24 HHCDA055I search key IEASYS00
2007/06/01 05:53:23.197 00000C24 HHCDA055I search key SYS1.LINKLIB
2007/06/01 05:53:23.197 00000C24 HHCDA055I search key LNKLST00
2007/06/01 05:53:23.197 00000C24 HHCDA055I search key SYS1.CMDLIB
2007/06/01 05:53:23.212 00000C24 HHCDA055I search key SYS2.LINKLIB
2007/06/01 05:53:23.228 00000C24 HHCDA055I search key SYS2.CMDLIB
2007/06/01 05:53:23.244 00000C24 HHCDA055I search key IEAVNP10
2007/06/01 05:53:23.259 00000C24 HHCDA055I search key IEAOPT00
2007/06/01 05:53:23.275 00000C24 HHCDA055I search key IEAIPS00
2007/06/01 05:53:23.306 00000C24 HHCDA055I search key ILRPREAD
2007/06/01 05:53:23.322 00000C24 HHCDA055I search key IEAVNP04
2007/06/01 05:53:23.322 00000C24 HHCDA055I search key ILROPS00
2007/06/01 05:53:23.415 00000C24 HHCDA055I search key IEAVNPA8
2007/06/01 05:53:23.415 00000C24 HHCDA055I search key IEAVNP05
2007/06/01 05:53:23.415 00000C24 HHCDA055I search key SYS1.LPALIB
2007/06/01 05:53:23.572 00000C24 HHCDA055I search key IEAPAK00
2007/06/01 05:53:28.587 00000C24 HHCDA055I search key IEABLD00
2007/06/01 05:53:28.603 00000C24 HHCDA055I search key ALLOC
2007/06/01 05:53:28.603 00000C24 HHCDA055I search key E
2007/06/01 05:53:28.603 00000C24 HHCDA055I search key HEWL
2007/06/01 05:53:28.603 00000C24 HHCDA055I search key IEWL
2007/06/01 05:53:28.603 00000C24 HHCDA055I search key IEWLF440
2007/06/01 05:53:28.603 00000C24 HHCDA055I search key IFOX01
2007/06/01 05:53:28.603 00000C24 HHCDA055I search key IFOX11
2007/06/01 05:53:28.603 00000C24 HHCDA055I search key IFOX62
2007/06/01 05:53:28.603 00000C24 HHCDA055I search key LINK
2007/06/01 05:53:28.619 00000C24 HHCDA055I search key ALLOC
2007/06/01 05:53:28.619 00000C24 HHCDA055I search key E
2007/06/01 05:53:28.619 00000C24 HHCDA055I search key LINK
2007/06/01 05:53:28.619 00000C24 HHCDA055I search key LOGOFF
2007/06/01 05:53:28.619 00000C24 HHCDA055I search key SUBMIT
2007/06/01 05:53:28.619 00000C24 HHCDA055I search key IEALOD00

```

Figure 177: T+CKD command

Example 2:

Turning the CKD key trace off.

```

2007/06/01 05:54:08.572 00000C24 t-ckd
2007/06/01 05:54:08.572 00000C24 HHCDA055I CKD KEY trace is now off

```

Figure 178: T-CKD command

7.117 T{+/-} dev (Turn CCW tracing on or off)

7.117.1 Function

This command turns the CCW tracing for a certain device on (T+dev) or turns it off (T-dev). It is possible to trace several devices concurrently. To enable the tracing of more than one device the T+ command must be issued for each device. The traces can be turned off independently of each other.

This function is similar to the CCW stepping described in section 7.88. The difference between these two function is that with CCW stepping the execution of every CCW has to be initiated by hitting ENTER on the Hercules console, whereas CCW tracing – once started – traces the instructions without interruption.

Please note that the tracing function will create an enormous amount of output in the Hercules log.

7.117.2 Syntax

Descriptive

T{+ | -} devaddr

Diagram

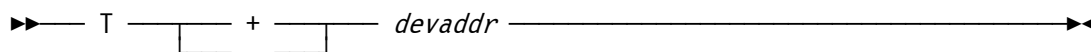

7.117.3 Parameter

- devaddr** This is the address of the device for which the CCW tracing is to be turned on or off.
- +** The plus sign turns on the CCW tracing for the given device. The plus sign must immediately follow the T command (without an intervening blank).
- The minus sign turns off the CCW tracing for the given device. The minus sign must immediately follow the T command (without an intervening blank).

7.117.4 Examples

Example 1:

Turn on the CCW tracing for device 0148.

```
t+0148
HHCPN136I CCW tracing is now on for device 0148
0148:start i/o file[0] bufcur -1 cache[-1]
HHCCP048I 0148:CCW=02000000 60000018=>02000000 60000018 00000000 00000000 .....
0148:HHCDA038I seeking to cyl 0 head 0
0148:read trk 0 (asynchronous)
0148:0 rdtrk 0
```

```

0148:0 rdtrk[0] 0 cache miss
0148:0 rdtrk[0] 0 buf 00DA4FA0 len 56832
0148:trk[0] read_trkimg
0148:file[0] l2[0,0] trk[0] read_l2ent 0x710
0148:file[0] read_l2 0 active -1 -1 -1
0148:l2[0,0] cache[0] miss
0148:file[0] fd[5] read, off 0x710 len 2048
0148:file[0] cache[0] l2[0] read offset 0x710
0148:file[0] l2[0,0] trk[0] read_l2ent 0xf10 3057 3057
0148:file[0] fd[5] read, off 0xf10 len 3057
0148:0 rdtrk[0] 0 complete buf 00DA4FA0:0100000000
0148:uncompress comp 1 len 3057 maxlen 56832 trk 0
0148:newbuf malloc 00DBCEC8 len 56832
0148:uncompress zlib newlen 6491 rc 0
0148:validating trk 0 len 6491 0000000000 0000000000000008
0148:read trk 0 uncompressed len 6491
0148:HHCDA041I read count orientation is index
0148:HHCDA043I cyl 0 head 0 record 0 kl 0 dl 8 of 0
0148:HHCDA043I cyl 0 head 0 record 1 kl 4 dl 24 of 0
0148:HHCDA045I read data 24 bytes
HHCCP075I 0148:Stat=0C00 Count=0000 =>00080000 8000015A 06004A98 60000060 .....!...q...-
HHCCP048I 0148:CCW=06004A98 60000060=>00000000 00000000 00000000 00000000 .....
0148:HHCDA041I read count orientation is data
0148:HHCDA043I cyl 0 head 0 record 2 kl 4 dl 144 of 0
0148:HHCDA045I read data 144 bytes
HHCCP075I 0148:Stat=0C00 Count=0000 =>07004AB8 40000006 31004ABE 40000005 ....
HHCCP048I 0148:CCW=08004A98 00000000=>07004AB8 40000006 31004ABE 40000005 ....
.
.
.
0148:HHCDA041I read count orientation is count
0148:HHCDA043I cyl 0 head 0 record 1 kl 4 dl 24 of 0
HHCCP075I 0148:Stat=0C00 Count=0000
HHCCP048I 0148:CCW=08004AA0 00000000=>31004ABE 40000005 08004AA0 00000000 ....
HHCCP048I 0148:CCW=31004ABE 40000005=>00000000 04000000 00000000 00000000 .....
0148:HHCDA041I read count orientation is count
0148:HHCDA043I cyl 0 head 0 record 2 kl 4 dl 144 of 0
HHCCP075I 0148:Stat=0C00 Count=0000
HHCCP048I 0148:CCW=08004AA0 00000000=>31004ABE 40000005 08004AA0 00000000 ....
HHCCP048I 0148:CCW=31004ABE 40000005=>00000000 04000000 00000000 00000000 .....
0148:HHCDA041I read count orientation is count
0148:HHCDA043I cyl 0 head 0 record 3 kl 4 dl 80 of 0
HHCCP075I 0148:Stat=0C00 Count=0000
HHCCP048I 0148:CCW=08004AA0 00000000=>31004ABE 40000005 08004AA0 00000000 ....
HHCCP048I 0148:CCW=31004ABE 40000005=>00000000 04000000 00000000 00000000 .....
0148:HHCDA041I read count orientation is count
0148:HHCDA043I cyl 0 head 0 record 4 kl 0 dl 6170 of 0
HHCCP075I 0148:Stat=4C00 Count=0000
HHCCP048I 0148:CCW=06000000 20002F55=>00080000 8000015A 06004A98 60000060 .....!...q...-
0148:HHCDA045I read data 6170 bytes
HHCCP075I 0148:Stat=0C00 Count=173B =>00080000 800005EC 40404040 F0F04040 ..... 00
0148:end i/o bufcur 0 cache[0] waiters 0

```

Figure 179: T+ dev command

Example 2:

Turn off the CCW tracing for device 0148.

```
2007/06/30 14:21:05.156 00000FC4 t-0148
2007/06/30 14:21:05.156 00000FC4 HHCPN136I CCW tracing is now off for device 0148
```

Figure 180: T- dev command

Example 3:

Turn on the CCW tracing for several devices.

```
2007/06/30 14:23:15.246 00000FC4 t+0148
2007/06/30 14:23:15.246 00000FC4 HHCPN136I CCW tracing is now on for device 0148
2007/06/30 14:23:15.246 00000FC4 t+0561
2007/06/30 14:23:15.246 00000FC4 HHCPN136I CCW tracing is now on for device 0561
```

Figure 181: T+ dev command (several devices)

7.118 TIMERINT (Display or set timers update interval)

7.118.1 Function

The TIMERINT parameter displays or sets the internal timer update interval in microseconds. This parameter specifies how frequently Hercules's internal timers-update thread updates the TOD clock, CPU Timer and other architectural related clock and timer values.

The default interval is 50 microseconds which attempts to strike a reasonable balance between clock accuracy and overall host performance.

7.118.2 Syntax

Descriptive

TIMERINT [*interval*]

Diagram

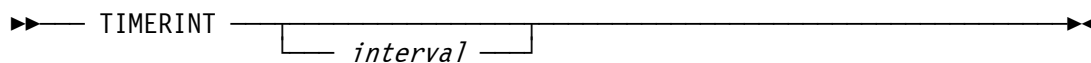

7.118.3 Parameter

interval Specifies the timer update interval in microseconds. The minimum allowed value for the interval is 1 microsecond and the maximum is 1'000'000 microseconds (one second).

CAUTION: While a lower TIMERINT value may help increase the accuracy of the guest's TOD clock and CPU Timer values, it could also have severe negative impact on the overall performance of the host operating system. This is especially true when a low TIMERINT value is coupled with a high HERCPRIO and TODPRIO priority setting.

Exercise extreme caution when choosing your desired TIMERINT in relationship to your chosen HERCPRIO and TODPRIO priority settings.

7.118.4 Examples

Example 1:

Display current timers update interval.

```
2007/06/30 14:04:44.578 00000FC4 timerint
2007/06/30 14:04:44.578 00000FC4 HHCPN037I Timer update interval = 50 microsecond(s)
```

Figure 182: TIMERINT command (list current value)

Example 2:

Set a new timers update interval.

```
2007/06/30 14:04:55.296 00000FC4 timerint 100
2007/06/30 14:04:55.296 00000FC4 HHCPN037I Timer update interval = 100 microsecond(s)
```

Figure 183: TIMERINT command (set new value)

7.119 TLB (Display TLB tables)

7.119.1 Function

The TLB command shows the actual contents of the TLB (Translation Lookaside Buffer) tables.

7.119.2 Syntax

Descriptive

TLB

Diagram

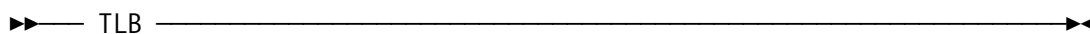

7.119.3 Parameter

None.

7.119.4 Examples

Example 1:

Display the TLB tables.

```
00000FC4 tlb
00000FC4 tlbID 0x0011c4 mainstor 10041000
00000FC4 ix          asd          vaddr          pte    id c p r w ky          main
00000FC4 *000 000000003fffe07f 0000000000000000 0000000000000000 11c4 0 0 0 0 00 3fbe3000
00000FC4 *001 00000000022b907f 0000000001801000 000000003e91e008 11c4 1 0 0 0 00 3f11d000
00000FC4 *002 00000000022b907f 0000000001802000 000000003e91f008 11c4 1 0 0 0 00 3f121000
.
several lines not displayed
.
00000FC4 *3fd 000000000a9eb07f 00000000013fd000 000000003f760208 11c4 1 1 0 0 00 3e41b000
00000FC4 *3fe 000000000a9eb07f 000000007fffe000 000000000aef4000 11c4 0 0 0 0 00 5508a000
00000FC4 *3ff 000000000a9eb07f 0000000000fff000 000000003f362208 11c4 1 1 0 0 00 3fc1b000
00000FC4 792 tlbID matches
```

Figure 184: TLB command

7.120 TODDRAG (Display or set TOD clock drag factor)

7.120.1 Function

The TODDRAG command displays the current setting of the TOD clock drag factor or sets a new value. This parameter can be used to slow down or speed up the TOD clock by a factor of *nn*. A significant slow-down can improve the performance of some operating systems which consume large amounts of CPU time processing timer interrupts. A drag factor of 2.0 slows down the clock by 50%, a drag factor of 0.5 doubles the speed of the clock, a drag factor of 1.01 slows down the clock by 1% and 0.99 speeds up the clock by 1%.

7.120.2 Syntax

<p><u>Descriptive</u></p> <p>TODDRAG [factor]</p> <p><u>Diagram</u></p>

7.120.3 Parameter

factor The factor to which the TOD clock has to be slowed down or sped up.

7.120.4 Examples

Example 1:

Display current TOD clock drag factor.

```
2007/06/30 14:33:29.653 00000FC4 toddrag
2007/06/30 14:33:29.653 00000FC4 HHCPN036I TOD clock drag factor = 1.000000
```

Figure 185: TODDRAG command (display TOD clock factor)

Example 2:

Set the TOD clock drag factor.

```
2007/06/30 14:33:29.653 00000FC4 toddrag 0.99
2007/06/30 14:33:29.653 00000FC4 HHCPN036I TOD clock drag factor = 0.990000
```

Figure 186: TODDRAG command (set TOD clock factor)

7.121 TRACEOPT (Instruction trace display options)

7.121.1 Function

The TRACEOPT command determines how the registers are displayed during instruction tracing and stepping. Entering the command without any argument simply displays the current trace mode.

7.121.2 Syntax

Descriptive

TRACEOPT [TRADITIONAL | REGSFIRST | NOREGS]

Diagram

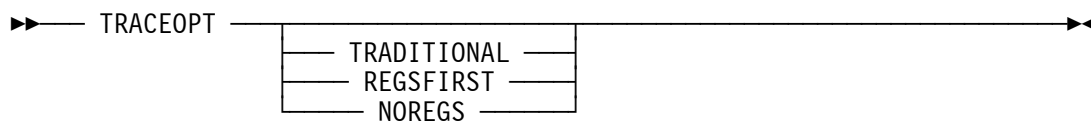

7.121.3 Parameter

TRADITIONAL Displays the registers following the instruction about to be executed such that pressing enter (to execute the displayed instruction) then shows the next instruction to be executed followed by the updated registers display.

REGSFIRST Displays the current register contents followed by the instruction about to be executed such that pressing enter (to execute the displayed instruction) then shows the updated registers followed by the next instruction to be executed.

NOREGS Suppresses the registers display altogether and shows just the instruction to be executed.

7.121.4 Examples

Example 1:

Display the instruction trace in traditional mode (instruction followed by registers).

```
traceopt traditional
HHCPN162I Hercules instruction trace displayed in traditional mode

CPU0000: PSW=00080000 800005EC INST=B7000444 LCTL 0,0,1092(0) load_control
CPU0000: R:00000444:K:06=01B00200 0000007F FE000000 00000001 .....#.....
CPU0000: GR00=00000000 GR01=00000000 GR02=00000000 GR03=00000000
CPU0000: GR04=00000000 GR05=00000000 GR06=00000000 GR07=00000000
CPU0000: GR08=00000000 GR09=00000000 GR10=00000000 GR11=00000000
CPU0000: GR12=00000000 GR13=00000000 GR14=00000000 GR15=00000000
```

Figure 187: TRACEOPT command (TRADITIONAL)

Example 2:

Display the instruction trace in regsfirst mode (registers followed by instruction).

```
traceopt regsfirst
HHCPN162I Hercules instruction trace displayed in regsfirst mode

CPU0000: GR00=00000000 GR01=00000000 GR02=00000000 GR03=00000000
CPU0000: GR04=00000000 GR05=00000000 GR06=00000000 GR07=00000000
CPU0000: GR08=00000000 GR09=00000000 GR10=00000000 GR11=00000000
CPU0000: GR12=00000000 GR13=00000000 GR14=00000000 GR15=00000000
CPU0000: PSW=00080000 800005F4 INST=A7F40002 BRC 15,4 branch_relative_on_condition
```

Figure 188: TRACEOPT command (REGSFIRST)

Example 3:

Display the instruction trace in noregs mode (instruction only).

```
traceopt noregs
HHCPN162I Hercules instruction trace displayed in noregs mode

CPU0000: PSW=00080000 800005FC INST=D207006804B8 MVC 104(8,0),1208(0) move_character
CPU0000: R:00000068:K:06=000A0000 0002007B 00000000 00000000 .....#.....
CPU0000: R:000004B8:K:06=00080000 80000606 20000000 00100000 .....
CPU0000: PSW=00080000 80000602 INST=B2790000 SACF 0(0) set_address_space_control_fast
CPU0000: R:00000000:K:06=00080000 800005EC 40404040 F0F04040 ..... 00
```

Figure 189: TRACEOPT command (NOREGS)

7.122 TT32 (Control / query CTCI-W32 functionality)

7.122.1 Function

The TT32 command controls or queries the CTCI-W32 functionality for a given device address. It allows you to enable or disable global CTCI-W32 debug tracing, or displays TunTap32 statistics for the specified CTC device.

7.122.2 Syntax

Descriptive

TT32 {DEBUG | NODEBUG | STATS *devnum*}

Diagram

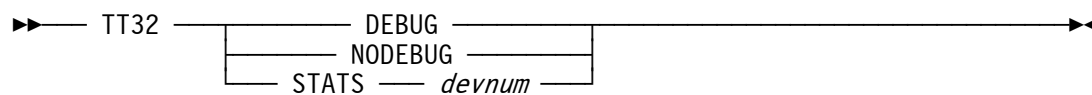

7.122.3 Parameter

- DEBUG** Enable global CTCI-W32 debug tracing.
- NODEBUG** Disable global CTCI-W32 debug tracing.
- STATS** Display TunTap32 statistics for CTC device.
- devnum** Device number of the device for which the TunTap32 statistics have to displayed.

7.122.4 Examples

Example 1:

Enable global CTCI-W32 debug tracing.

```
2007/06/30 17:29:16.296 00000FC4 tt32 debug
2007/06/30 17:29:16.296 00000FC4 HHCPNxxxI TT32 debug tracing messages enabled
```

Figure 190: TT32 DEBUG command

Example 2:

Disable global CTCI-W32 debug tracing.

```
2007/06/30 17:29:16.296 00000FC4 tt32 nodebug
2007/06/30 17:29:16.296 00000FC4 HHCPNxxxI TT32 debug tracing messages disabled
```

Figure 191: TT32 NODEBUG command**Example 3:**

Display TunTap32 statistics for device 0E20.

```
2007/06/30 14:33:48.762 00000FC4 tt32 stats 0e20
2007/06/30 14:33:48.762 00000FC4 TunTap32.dll Statistics:
2007/06/30 14:33:48.762 00000FC4
2007/06/30 14:33:48.762 00000FC4 Size of Kernel Hold Buffer:      1024K
2007/06/30 14:33:48.762 00000FC4 Size of DLL I/O Buffer:      64K
2007/06/30 14:33:48.762 00000FC4 Maximum DLL I/O Bytes Received:  4K
2007/06/30 14:33:48.762 00000FC4
2007/06/30 14:33:48.762 00000FC4          0 Write Calls
2007/06/30 14:33:48.762 00000FC4          0 Write I/Os
2007/06/30 14:33:48.762 00000FC4          346 Read Calls
2007/06/30 14:33:48.762 00000FC4          1770 Read I/Os
2007/06/30 14:33:48.762 00000FC4          950 Packets Read
2007/06/30 14:33:48.762 00000FC4          0 Packets Written
2007/06/30 14:33:48.762 00000FC4          524372 Bytes Read
2007/06/30 14:33:48.762 00000FC4          0 Bytes Written
2007/06/30 14:33:48.762 00000FC4          0 Internal Packets
2007/06/30 14:33:48.762 00000FC4          913 Ignored Packets
```

Figure 192: TT32 STATS command

7.123 U (Disassemble storage)

7.123.1 Function

The U command lets you disassemble storage. The argument specifies the storage address to be disassembled. The length of the storage area can be given as an optional argument. The listed storage area is formatted as one line per instruction. Every instruction is shown as a hexadecimal string and as readable assembler statement. Storage areas that can not be disassembled (data areas) are marked with question marks.

7.123.2 Syntax

Descriptive

U *address* [*.length*]

Diagram

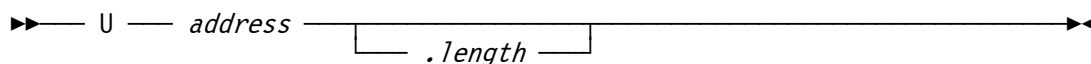

7.123.3 Parameter

address The address of the storage area that is to be disassembled.

length The length of the storage that is to be disassembled. This value must be specified in hexadecimal. If the length is omitted then 64 bytes of storage are disassembled by default. The length argument must follow immediately the address parameter, separated by a dot ("address.length").

7.123.4 Examples

Example 1:

Disassemble 16'534 bytes beginning at address 00040130.

```
00000C24 u 00040130.4096
00000C24 P00040130: 90DF02EC      STM  13,15,748(0)      store_multiple
00000C24 P00040134: 4166000C      LA   6,12(6,0)        load_address
00000C24 P00040138: 58606160      L    6,352(0,6)       load
00000C24 P0004013C: 58300010      L    3,16(0,0)        load
00000C24 P00040140: 58430184      L    4,388(3,0)       load
00000C24 P00040144: 55C06058      CL   12,88(0,6)       compare_logical
00000C24 P00040148: 478060E0      BC   8,224(0,6)       branch_on_condition
00000C24 P0004014C: 8840000A      SRL  4,10(0)           shift_right_single_logical
00000C24 P00040150: 47F060E4      BC   15,228(0,6)      branch_on_condition
```

7.124 UPTIME (Display Hercules Emulator uptime)

7.124.1 Function

The UPTIME console command displays how long the Hercules Emulator has been running.

7.124.2 Syntax

Descriptive

UPTIME

Diagram

▶— UPTIME —▶

7.124.3 Parameter

None.

7.124.4 Examples

Example 1:

Display how long the Hercules Emulator has been running so far (uptime < 1 day).

```
2009/06/15 01:02:53.500 00000C54 uptime
2009/06/15 01:02:53.500 00000C54 Hercules has been up for 06:33:12.
```

Figure 194: UPTIME command (uptime < 1 day).

Example 2:

Display how long the Hercules Emulator has been running so far (uptime > 1 week).

```
2009/06/15 01:02:53.500 00000C54 uptime
2009/06/15 01:02:53.500 00000C54 Hercules has been up for 3 weeks, 5 days, 16:48:15.
```

Figure 195: UPTIME command (uptime > 1 week).

7.125 V (Display or alter virtual storage)

7.125.1 Function

The V command displays or alters virtual storage.

7.125.2 Syntax

Descriptive

V [P | S | H] {*addr* | *addr.length* | *addr-addr* | *addr=value*}

Diagram

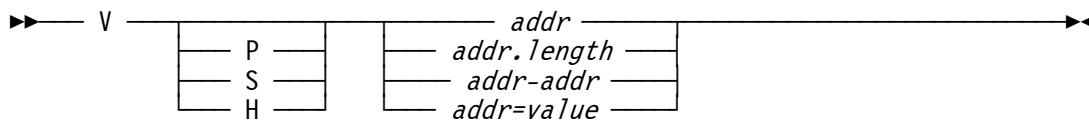

7.125.3 Parameter

- addr** Address of the virtual storage area that is to be displayed or altered.
- length** Length of the storage area that is to be displayed. The value of *.len* must be given in hexadecimal. If the length is omitted then 64 bytes of virtual storage are displayed by default.
- P** The optional 'P' argument will force Primary translation instead of current PSW mode.
- S** The optional 'S' argument will force Secondary translation instead of current PSW mode.
- H** The optional 'H' argument will force Home translation instead of current PSW mode.
- addr-addr** Address range (from – to) of the virtual storage that is to be displayed.
- value** Value is a hex-string of up to 32 pairs of digits (16 bytes) which are to be written to the virtual storage address given by the *addr* parameter. After altering the storage 16 bytes of virtual storage starting at *addr* are displayed.

7.125.4 Examples

Example 1:

Display 256 (x'FF') bytes of virtual storage starting from address x'00010000'.

```
05:56:20.087 00000C24 v 00010000.ff
05:56:20.087 00000C24 V:00010000 (primary) R:00010000
05:56:20.087 00000C24 V:00010000:K:04=4770A1C8 5820901C 47F0A1F0 91802003 ..~H.....0~0j...
05:56:20.087 00000C24 V:00010010:K:04=47E0A1EC 58202004 47F0A1F0 96803200 .\~.....0~0o...
05:56:20.087 00000C24 V:00010020:K:04=91803200 4770A1FE 12224770 A1DC5850 j.....~.....~..&
05:56:20.087 00000C24 V:00010030:K:04=30201FCC 195C4770 A01C50C0 30245820 .....*.....&{....
05:56:20.087 00000C24 V:00010040:K:04=30089140 320047E0 A28441B0 202C58D0 ..j ...\sd.....}
05:56:20.087 00000C24 V:00010050:K:04=02FC98CD D19005ED 58C031F4 12CC4780 ..q.J....{.4....
05:56:20.087 00000C24 V:00010060:K:04=A24E9120 300047E0 A2424160 203047F0 s+j....\s...-...0
05:56:20.087 00000C24 V:00010070:K:04=A2464160 20485870 31F445E0 A2E458C0 s...-....4.\sU.{
05:56:20.087 00000C24 V:00010080:K:04=31F812CC 4780A262 187C4160 203045E0 .8....s..@.-... \
05:56:20.087 00000C24 V:00010090:K:04=A2E458C0 31FC12CC 4780A276 187C4160 sU.{.....s..@.-
05:56:20.087 00000C24 V:000100A0:K:04=204045E0 A2E441B0 202C58D0 02FC98CD . \sU.....}..q.
05:56:20.087 00000C24 V:000100B0:K:04=D19C05ED 91803001 4770A2DA 1FCC59C0 J...j....s....{
05:56:20.087 00000C24 V:000100C0:K:04=30504780 A2A691C0 32004770 A2A659C0 .&..swj{...sw.{
05:56:20.087 00000C24 V:000100D0:K:04=200C4780 A2DA58C0 305412CC 4770A2DA ....s..{.....s.
05:56:20.087 00000C24 V:000100E0:K:04=1F114180 0001BA18 30544770 A2DA5810 .....s...
05:56:20.087 00000C24 V:000100F0:K:04=305858F0 001058F0 F2645800 F0005000 ...0...02...0.&
```

Figure 196: V command (display virtual storage with length)

Example 2:

Change virtual storage at address x'00010000' to x'FFFFFFFF'.

```
05:58:33.728 00000C24 v 00010000=FFFFFFFF
05:58:33.728 00000C24 V:00010000 (primary) R:00010000
05:58:33.728 00000C24 V:00010000:K:06=FFFFFFFF 5820901C 47F0A1F0 91802003 .....0~0j...
```

Figure 197: V command (alter virtual storage)

Example 3:

Display virtual storage from address x'00010000' to address x'00010100'.

```
05:59:14.447 00000C24 v 00010000-00010100
05:59:14.447 00000C24 V:00010000 (primary) R:00010000
05:59:14.447 00000C24 V:00010000:K:06=FFFFFFFF 5820901C 47F0A1F0 91802003 .....0~0j...
05:59:14.447 00000C24 V:00010010:K:06=47E0A1EC 58202004 47F0A1F0 96803200 .\~.....0~0o...
05:59:14.447 00000C24 V:00010020:K:06=91803200 4770A1FE 12224770 A1DC5850 j.....~.....~..&
05:59:14.447 00000C24 V:00010030:K:06=30201FCC 195C4770 A01C50C0 30245820 .....*.....&{....
05:59:14.447 00000C24 V:00010040:K:06=30089140 320047E0 A28441B0 202C58D0 ..j ...\sd.....}
05:59:14.447 00000C24 V:00010050:K:06=02FC98CD D19005ED 58C031F4 12CC4780 ..q.J....{.4....
05:59:14.447 00000C24 V:00010060:K:06=A24E9120 300047E0 A2424160 203047F0 s+j....\s...-...0
05:59:14.447 00000C24 V:00010070:K:06=A2464160 20485870 31F445E0 A2E458C0 s...-....4.\sU.{
05:59:14.447 00000C24 V:00010080:K:06=31F812CC 4780A262 187C4160 203045E0 .8....s..@.-... \
05:59:14.447 00000C24 V:00010090:K:06=A2E458C0 31FC12CC 4780A276 187C4160 sU.{.....s..@.-
```

```

05:59:14.447 00000C24 V:000100A0:K:06=204045E0 A2E441B0 202C58D0 02FC98CD . .\sU.....}..q.
05:59:14.447 00000C24 V:000100B0:K:06=D19C05ED 91803001 4770A2DA 1FCC59C0 J...j.....s...{
05:59:14.447 00000C24 V:000100C0:K:06=30504780 A2A691C0 32004770 A2A659C0 .&..swj{...sw.{
05:59:14.447 00000C24 V:000100D0:K:06=200C4780 A2DA58C0 305412CC 4770A2DA ....s..{.....s.
05:59:14.447 00000C24 V:000100E0:K:06=1F114180 0001BA18 30544770 A2DA5810 .....s...
05:59:14.447 00000C24 V:000100F0:K:06=305858F0 001058F0 F2645800 F0005000 ...0...02...0.&.
05:59:14.447 00000C24 V:00010100:K:06=1004BA01 F0004770 A2CE982E 31C0947F ....0...s.q..{m"

```

Figure 198: V command (display virtual storage with range)

Example 4:

Display 256 (x'FF') bytes of virtual storage starting from address x'00010000'. Force Secondary translation instead of current PSW mode.

```

05:56:20.087 00000C24 v s 00010000.ff
05:56:20.087 00000C24 V:00010000 (secondary) R:00010000
05:56:20.087 00000C24 V:00010000:K:04=4770A1C8 5820901C 47F0A1F0 91802003 ..~H.....0~0j...
05:56:20.087 00000C24 V:00010010:K:04=47E0A1EC 58202004 47F0A1F0 96803200 .\~.....0~0o...
05:56:20.087 00000C24 V:00010020:K:04=91803200 4770A1FE 12224770 A1DC5850 j.....~.....~&
05:56:20.087 00000C24 V:00010030:K:04=30201FCC 195C4770 A01C50C0 30245820 .....*.....&{....
05:56:20.087 00000C24 V:00010040:K:04=30089140 320047E0 A28441B0 202C58D0 ..j ...\sd.....}
05:56:20.087 00000C24 V:00010050:K:04=02FC98CD D19005ED 58C031F4 12CC4780 ..q.J....{.4....
05:56:20.087 00000C24 V:00010060:K:04=A24E9120 300047E0 A2424160 203047F0 s+j....\s.-...0
05:56:20.087 00000C24 V:00010070:K:04=A2464160 20485870 31F445E0 A2E458C0 s.-.....4.\sU.{
05:56:20.087 00000C24 V:00010080:K:04=31F812CC 4780A262 187C4160 203045E0 .8....s.@.-... \
05:56:20.087 00000C24 V:00010090:K:04=A2E458C0 31FC12CC 4780A276 187C4160 sU.{.....s.@.-
05:56:20.087 00000C24 V:000100A0:K:04=204045E0 A2E441B0 202C58D0 02FC98CD . .\sU.....}..q.
05:56:20.087 00000C24 V:000100B0:K:04=D19C05ED 91803001 4770A2DA 1FCC59C0 J...j.....s...{
05:56:20.087 00000C24 V:000100C0:K:04=30504780 A2A691C0 32004770 A2A659C0 .&..swj{...sw.{
05:56:20.087 00000C24 V:000100D0:K:04=200C4780 A2DA58C0 305412CC 4770A2DA ....s..{.....s.
05:56:20.087 00000C24 V:000100E0:K:04=1F114180 0001BA18 30544770 A2DA5810 .....s...
05:56:20.087 00000C24 V:000100F0:K:04=305858F0 001058F0 F2645800 F0005000 ...0...02...0.&.

```

Figure 199: V command (display virtual storage with 'S' option)

7.126 VERSION (Display version information)

7.126.1 Function

The version command is used to display various version and build information about the Hercules emulator.

7.126.2 Syntax

Descriptive

VERSION

Diagram

▶— VERSION —▶

7.126.3 Parameter

None.

7.126.4 Examples

Example 1:

Display the Hercules version information.

```
06:00:00.025 00000C24 version
06:00:00.025 00000C24 Hercules Version 3.06
06:00:00.025 00000C24 (c)Copyright 1999-2007 by Roger Bowler, Jan Jaeger, and others
06:00:00.025 00000C24 Built on Jan 10 2009 at 01:56:22
06:00:00.025 00000C24 Build information:
06:00:00.025 00000C24   Win32 (MSVC) build
06:00:00.025 00000C24   Modes: S/370 ESA/390 z/Arch
06:00:00.025 00000C24   Max CPU Engines: 8
.
.
.
06:00:00.025 00000C24   Automatic Operator support
06:00:00.025 00000C24   Machine dependent assists: cmpxchg1 cmpxchg4 cmpxchg8 fetch_dw store_dw
06:00:00.025 00000C24 Running on Micky Windows_NT-5.1 i686 MP=2
```

Figure 200: VERSION command

8. Hercules Utilities

8.1 Overview

Several utility programs exist to support the Hercules Emulator. Most of them are used when working with DASD and TAPE files. Other utilities perform some special functions with configuration files.

All these utility programs are pure line-command mode programs (i.e. Windows DOS or Unix/Linux shell). They can be called manually from the command line prompt or built into batch files. This is generally the preferred method due to its greater flexibility and automation possibilities.

If the Hercules Windows GUI (HercWinGUI) is used the utilities can also be called interactively via the GUI and using a graphical and menu driven interface.

8.1.1 DASD Utilities

The following table shows the utilities that are used for DASD image file maintenance:

Utility Name	Function
CCKDCDSK	CCKD DASD file integrity verification, recovery and repair utility
CCKDCOMP	CCKD DASD file compression utility
CCKDDIAG	CCKD DASD file diagnostics utility
CKDSWAP	CCKD DASD file swap-endian program
CKD2CCKD	Copy CKD DASD file to CCKD DASD file
CCKD2CKD	Copy CCKD DASD file to CKD DASD file
DASDCAT	Display PDS datasets and members
DASDCONV	DASD image file conversion program
DASDCOPY	Copy DASD file to another DASD file
DASDINIT	DASD image file creation
DASDISUP	Fix XCTL tables in SVCLIB
DASDLOAD	DASD loader program
DASDLS	List datasets on a volume
DASDPDSU	PDS unload utility
DASDSEQ	Display sequential datasets

Table 15: DASD image file maintenance utilities

8.1.2 TAPE Utilities

The following table shows the utilities that are used for TAPE file maintenance:

Utility Name	Function
HETGET	Extract files from an AWS or HET tape file
HETINIT	Initialize an AWS or HET tape file
HETMAP	Show information about a HET or AWS tape file
HETUPD	Update and/or copy an AWS or HET tape file
TAPECOPY	Copy a SCSI tape to or from an AWSTAPE disk file
TAPEMAP	Show information about an AWS tape file
TAPESPLT	Split an AWS tape file

Table 16: TAPE file maintenance utilities

8.1.3 Miscellaneous Utilities

The following table shows utilities used for miscellaneous functions:

Utility Name	Function
DMAP2HRC	P/390 DEVMAP conversion program

Table 17: Miscellaneous utilities

8.1.4 Third Party Utilities

The following table shows “third party” utilities used for various functions:

Utility Name	Function
PRT PUB	Mainframe print publishing program

Table 18: Third party utilities

8.1.5 Mainframe Utilities

The utilities according to the next table will run on the mainframe and provide various functionality that is useful for Hercules users:

Utility Name	Function
AWSSL	AWS virtual tape utility
AWSUTIL	AWS format tape file generation utility
RAWSTAPE	Reverse AWSTAPE utility
VTTS	Virtual tape transportation system

Table 19: Mainframe utilities

8.2 CCKDCDSK (CCKD DASD file integrity verification, recovery and repair utility)

8.2.1 Function

The CCKDCDSK utility performs compressed or shadowed CKD DASD emulation file integrity verification and recovery and repair. Calling the utility without any arguments will display a help information.

8.2.2 Syntax

Descriptive

CCKDCDSK [-option [-option ...]] filename

Diagram

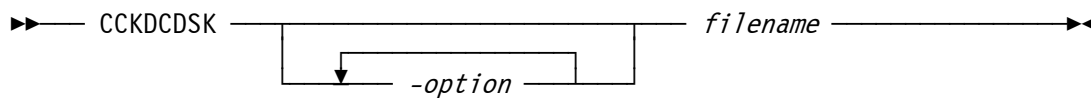

8.2.3 Parameter

Options:

- v Display version information and exit.
- f Force check, even if OPENED bit is on.
- ro Open the DASD file read-only, no repairs are done.
- level The level of checking that is to be performed. The higher the level the longer the integrity check takes. The level is any number from 1 - 4.
 - Level 1 performs a minimal check. Device headers are verified, free space is verified, primary lookup table and secondary lookup tables are verified.
 - Level 2 performs a normal check. These are the same checks as in level 1 plus all 5-byte track headers are verified.
 - Level 3 performs the maximum checking. These are the same checks as in level 1 plus all track images are read, uncompressed and verified.
 - Level 4 recovers everything.

Arguments:

filename Name of the CCKD DASD image file to be checked.

8.2.4 Examples

Example 1:

Perform a minimal checking of a CCKD DASD file without doing any repairs.

```
CCKDCDSK -0 -ro D:\MVS\DASD\MVSRES.148
```

Example 2:

Perform a maximum level check and repair of a CCKD DASD file and force the check even the OPENED bit is set on.

```
CCKDCDSK -r -f D:\MVS\DASD\MVSRES.148
```

8.2.5 Sample Utility Output

Sample 1:

Perform a maximum level check and repair of a CCKD DASD file and force the check even the OPENED bit is set on.

```
D:\HERCULES>cckdcchk -3 -ro D:\MVS\DASD\MVSRES.148  
size 301956072 used 301956072 free 0 imbed 0 first 0x0 number 0
```

Figure 201: CCKDCDSK utility output

8.3 CCKDCOMP (CCKD DASD file compression utility)

8.3.1 Function

The CCKDCOMP utility removes all free space from a compressed or shadow CKD DASD emulation file. If *level* is specified then the CCKDCDSK utility is called first with the specified level; this is a short-hand method to call both functions in one utility call.

8.3.2 Syntax

Descriptive

CCKDCOMP [-option [-option ...]] filename

Diagram

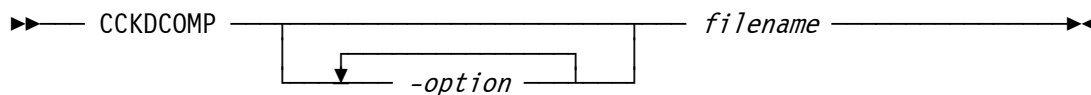

8.3.3 Parameter

Options:

- v Display version information and exit.
- f Force check even if OPENED bit is on.
- level The level of checking that is to be performed. The higher the level the longer the integrity check takes. The level is any number from 1 - 4.
 - Level 1 performs a minimal check. Device headers are verified, free space is verified, primary lookup table and secondary lookup tables are verified.
 - Level 2 performs a normal check. These are the same checks as in level 1 plus all 5-byte track headers are verified.
 - Level 3 performs the maximum checking. These are the same checks as in level 1 plus all track images are read, uncompressed and verified.
 - Level 4 recovers everything.

Arguments:

filename Name of DASD image file to be compressed.

8.3.4 Examples

Example 1:

Compress a CCKD DASD file.

```
CCKDCOMP D:\MVS\DASD\MVSRES.148
```

Example 2:

Compress a CCKD DASD file and perform integrity checking and repair.

```
CCKDCOMP -3 D:\MVS\DASD\MVSRES.148
```

8.3.5 Sample Utility Output

Sample 1:

Compress a CCKD DASD file and perform integrity checking and repair.

```
D:\HERCULES>cckdcomp -3 D:\MVS\DASD\MVSRES.148  
cckdcomp: completed: moves 33665  moved 301552856  freed 407400
```

Figure 202: CCKDCOMP utility output

8.4 CCKDDIAG (CCKD DASD file diagnostics utility)

8.4.1 Function

The CCKDDIAG utility is the diagnostic program which allows you to examine various aspects of a CCKD DASD image file.

8.4.2 Syntax

Descriptive

CCKDDIAG [-option [-option ...]] filename

Diagram

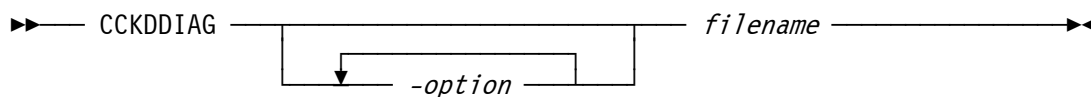

8.4.3 Parameter

Options:

- v Display version information and exit.
- d Display DEVHDR.
- c Display CDEVHDR.
- 1 Display L1TAB (numeric one).
- g Enable debug output.

CKD track related options:

- a *cc hh* Display absolute *CCHH* data.
- r *tt* Display relative *TT* data.
- 2 Display L2TAB related to -a or -r.
- t Display track data.
- x Hex display track / key data.

Offset option:

- o *oo ll* Hex display data at offset *oo* of length *ll*.

Arguments:

filename Name of DASD image file to be compressed.

8.4.4 Examples

Example 1:

Display the DEVHDR and CDEVHDR for a CCKD DASD image file.

```
CCKDDIAG -d -c D:\MVS\DASD\MVSRES.148
```

Example 2:

Display the L1TAB and enable debug output for a CCKD DASD image file.

```
CCKDDIAG -l -g D:\MVS\DASD\MVSRES.148
```

Example 3:

Display relative TT data for a CCKD DASD image file.

```
CCKDDIAG -r 15 D:\MVS\DASD\MVSRES.148
```

8.4.5 Sample Utility Output

Sample 1:

Display the DEVHDR and CDEVHDR for a CCKD DASD image file and additionally enable debug output.

```
D:\Hercules>cckddiag -d -c -g D:\MVS\DASD\MVSRES.148c

READPOS seeking 0 (0x00000000)
READPOS reading buf addr 0012FA68 length 512 (0x00000200)

DEVHDR - 512 (decimal) bytes:
+0000 434B445F 43333730 1E000000 004C0000  C.D^C370.....<..
+0010 50000000 00000000 00000000 00000000  &.....
+0020 00000000 00000000 00000000 00000000  .....

3350 device has 30 heads/cylinder

READPOS seeking 512 (0x00000200)
READPOS reading buf addr 0012FC68 length 512 (0x00000200)

CDEVHDR - 512 (decimal) bytes:
+0000 00030141 42000000 00010000 0CFF5901  ...AB.....Y.
+0010 21F74901 19631500 EB071000 5CE90E00  !7I..c.....*Z..
+0020 0B000000 00000000 30020000 00010500  .....0.....
+0030 00000000 00000000 00000000 00000000  .....
```

```
MAKBUF malloc L1TAB buffer of 264 bytes at 003B2860  
  
READPOS seeking 1024 (0x00000400)  
READPOS reading buf addr 003B2860 length 264 (0x00000108)
```

Figure 203: CCKDDIAG utility output

8.5 CCKDSWAP (CCKD DASD file swap-endian program)

8.5.1 Function

The CCKDSWAP utility is the swap-endian program, it swaps the byte order of a CCKD file.

8.5.2 Syntax

Descriptive

CCKDSWAP *filename*

Diagram

▶— CCKDSWAP — *filename* —▶

8.5.3 Parameter

filename Name of CCKD DASD image file to have its byte order swapped.

8.5.4 Examples

Example 1:

Swap byte order for a CCKD DASD image file.

```
CCKDSWAP D:\MVS\DASD\MVSRES.148
```

8.5.5 Sample Utility Output

Sample 1:

Swap byte order for a CCKD DASD image file.

```
D:\HERCULES>cckdswap D:\MVS\DASD\MVSRES.148
Hercules cckd swap-endian program Version 3.05
(c)Copyright 1999-2005 by Roger Bowler, Jan Jaeger, and others
cckdswap: D:\MVS\DASD\MVSRES.148 changed from little-endian to big-endian
```

Figure 204: CCKDSWAP utility output

8.6 CKD2CCKD (Copy CKD DASD file to CCKD DASD file)

8.6.1 *Function*

The CKD2CCKD is used to copy (convert) an uncompressed CKD DASD file to a compressed CCKD DASD file. This utility is obsolete, it is replaced through the DASDCOPY utility which performs the same and additional functions. For details see DASDCOPY utility.

8.6.2 *Syntax*

See DASDCOPY utility.

8.6.3 *Parameter*

See DASDCOPY utility.

8.6.4 *Examples*

See DASDCOPY utility.

8.6.5 *Sample Utility Output*

See DASDCOPY utility.

8.7 CCKD2CKD (Copy CCKD DASD file to CKD DASD file)

8.7.1 Function

The CCKD2CKD is used to copy (convert) a compressed CCKD DASD file to an uncompressed CKD DASD file. This utility is obsolete, it is replaced through the DASDCOPY utility which performs the same and additional functions. For details see DASDCOPY utility.

8.7.2 Syntax

See DASDCOPY utility.

8.7.3 Parameter

See DASDCOPY utility.

8.7.4 Examples

See DASDCOPY utility.

8.7.5 Sample Utility Output

See DASDCOPY utility.

8.8 DASDCAT (Display PDS datasets and members)

8.8.1 Function

The DASDCAT utility displays pds datasets and members from a DASD image file. It can generate a list of members in a given PDS dataset or can list the contents of a single member or all members in a PDS.

8.8.2 Syntax

Descriptive

```
DASDCAT [-i image [SF=shadowfile] pdsname/spec:flags]
```

Diagram

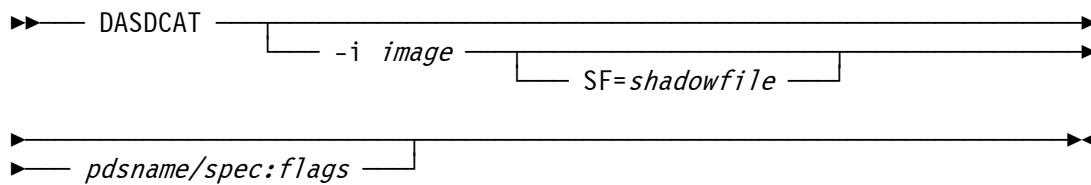

8.8.3 Parameter

- i image** The name (and optionally path) of the DASD image file.
- shadowfile** The (optional) name of an associated shadow DASD file.
- pdsname** The name of the partitioned dataset from which information will be extracted.
- spec** *spec* can be one of the following:
- The name of a PDS member to be listed.
 - An asterisk (“*”), meaning that all members in the PDS are to be listed.
 - A question mark (“?”) which causes the list of members in the PDS to be returned.
- flags** *flags* can be one of the following:
- “c” (list the member(s) as card images)
 - “a” (list the member(s) in ASCII)

If no arguments are given the program displays help text and exits.

8.8.4 Examples

Example 1:

Create a member list of PDS SYS1.PARMLIB on volume MVSRES.148.

```
DASDCAT -i D:/MVS/DASD/MVSRES.148 SYS1.PARMLIB/?
```

Example 2:

Print member IEASLP00 from PDS SYS1.PARMLIB on volume MVSRES.148 as card images.

```
DASDCAT -i D:/MVS/DASD/MVSRES.148 SYS1.PARMLIB/IEASLP00:c
```

Example 3:

Print all members from PDS SYS1.PARMLIB on volume MVSRES.148 as card images.

```
DASDCAT -i D:/MVS/DASD/MVSRES.148 SYS1.PARMLIB/*:c
```

8.8.5 Sample Utility Output

Sample 1:

Create a member list of PDS SYS1.PARMLIB on volume MVSRES.148

```
D:\Hercules>dasdcat -i D:/MVS/DASD/MVSRES.148 SYS1.PARMLIB/?
Hercules DASD cat program Version 3.05
(c)Copyright 1999-2006 by Roger Bowler, Jan Jaeger, and others
commnd00
gtfparm
ieaabd00
ieaapf00
ieabld00
ieadmp00
.
.
.
lnklst00
mvikey00
rpfkey00
smfprm00
tsokey00
vatlst00
```

Figure 205: DASDCAT utility output (create PDS member list)

Sample 2:

Print member IEAIPS00 from PDS SYS1.PARMLIB on volume MVSRES.148 as card images.

```
D:\Hercules>dasdcats -i D:/MVS/DASD/MVSRES.148 SYS1.PARMLIB/IEAIPS00:c
Hercules DASD cat program Version 3.05
(c)Copyright 1999-2006 by Roger Bowler, Jan Jaeger, and others
CPU=10.0,IOC=5.0,MSO=3.0          /* DEFAULT IPS --IEAIPS00-- */
WKL=(1,50,99,100)
OBJ=1,SRV=(1000,*,*,0)           /* FIRST PERIOD BATCH (DMN1) */
OBJ=2,SRV=(1000,*,*,0)           /* SECOND PERIOD BATCH (DMN1) */
OBJ=3,SRV=(1000,*,*,0)           /* FIRST PERIOD TSO (DMN2) */
OBJ=4,SRV=(1000,*,*,0)           /* SECOND PERIOD TSO (DMN2) */
OBJ=5,SRV=(1000,*,*,0)           /* THIRD PERIOD TSO (DMN3) */
OBJ=6,SRV=(1000,1000,1000,1000) /* HOT BATCH (DMN1) */
OBJ=7,SRV=(1000,1,0)             /* LOW PRIORITY BATCH (DMN1) */
DMN=1,CNSTR=(1,50,1)             /* BATCH */
DMN=2,CNSTR=(1,50,255)           /* SHORT AND MEDIUM TSO */
DMN=3,CNSTR=(1,50,16)            /* LONG TSO */
PGN=1,(DMN=1,APG=6,DUR=10K,ISV=10K,OBJ=1,RTB=0) /* BATCH -SHORT */
      (DMN=1,APG=6,ISV=10K,OBJ=2,RTB=0) /* -----MEDIUM */
PGN=2,(DMN=2,APG=14,DUR=600,ISV=600,OBJ=3,RTB=0) /* TSO -SHORT */
      (DMN=2,APG=13,DUR=1400,ISV=2K,OBJ=4,RTB=0) /* -----MEDIUM */
      (DMN=3,APG=6,ISV=10K,OBJ=5,RTB=0) /* -----LONG */
PGN=3,(DMN=1,APG=9,ISV=100K,OBJ=6,RTB=0) /* HOT BATCH */
PGN=4,(DMN=1,APG=6,ISV=10K,OBJ=7,RTB=0) /* LOW PRTY BATCH*/
```

Figure 206: DASDCAT utility output (list a member from a PDS)

Sample 3:

Print all members from PDS SYS1.PARMLIB on volume MVSRES.148 as card images.

```
D:\Hercules>dasdcat -i D:/MVS/DASD/MVSRES.148 SYS1.PARMLIB/*:c
Hercules DASD cat program Version 3.05
(c)Copyright 1999-2006 by Roger Bowler, Jan Jaeger, and others
> Member COMMND00
| TOD=NOPROMPT
> Member GTFARM
| TRACE=SYS,USR,TRC,DSP,PCI,SRM,RR,EXT,PI,SVC,IO,SIO
> Member IEAABD00
| SDATA=(ALLSDATA),PDATA=(ALLPDATA)
> Member IEAAPF00
| SYS1.LINKLIB                MVSRES,
| SYS1.SVCLIB                 MVSRES,
| SYS1.LPALIB                 MVSRES,
| SYS1.VTAMLIB                MVSRES,
| SYS1.INDMAC                 MVSRES
> Member IEABLD00
| SYS1.LINKLIB ALLOC,ALLOCATE,E,EDIT,HEWL,
|           IEWL,IEWLF128,IEWLF440,IEWLF880,IFOX01,IFOX02,IFOX03,
|           IFOX04,IFOX05,IFOX06,IFOX11,IFOX21,IFOX31,IFOX41,IFOX51,
|           IFOX61,IFOX62,LINK,LINKEDIT,LOADER,
|           LOGOFF,LOGON,SUBMIT,TEST
.
.
.
several lines not displayed
.
.
.
> Member TSOKEY00
| USERMAX=8,                  /* MAXIMUM TSO USERS           */
| RECONLIM=60,                /* MAXIMUM DISCONNECT MINUTES  */
| BUFRSIZE=132,               /* VTIOC BUFFER SIZE           */
| HIBFREXT=48000,             /* MAX BUFFERS BEFORE SWAP OUT  */
| LOBFREXT=24000,             /* MIMIMUM BUFFERS BEFORE SWAP IN */
| MODE=NOBREAK,               /* KEYBOARD LOCK OPTION        */
| MODESW=NO,                  /* MODESWITCH FROM TERMINAL OPTION */
| CHNLEN=4,                   /* NO. OF RU'S PER CHAIN       */
| SCRSIZE=1920                 /* MAXIMUM SCREEN SIZE         */
```

Figure 207: DASDCAT utility output (list all members of a PDS)

8.9 DASDCONV (DASD image file conversion program)

8.9.1 Function

The DASD CKD image conversion utility is used to convert HDR-30 CKD image files or compressed (.gz) image files to the AWSCKD format that is used by the Hercules Emulator. The .gz compressed format was recently used by IBM to ship the ADCD DASD image files for the FLEX-ES emulator.

8.9.2 Syntax

Descriptive

```
DASDCONV [-option [-option ... ]] {infile | - } outfile
```

Diagram

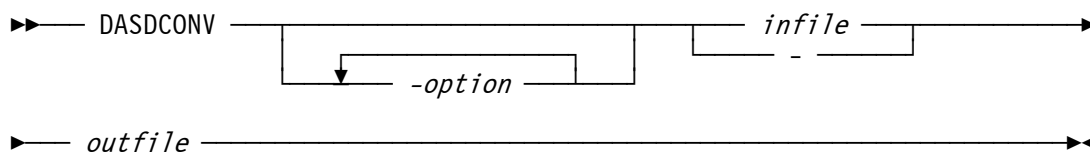

8.9.3 Parameter

Options:

- r Replace the output file if it already exists.
- lfs Output CKD file will be a single file even if it exceeds 2 GB in size.
- q The "-q" (quiet) option suppresses the progress messages.

Arguments:

- infile** The name (and optionally path) of the input HDR-30 CKD image file or the name of the compressed (.gz) image file.
- If the hyphen is specified instead of a filename, then DASDCONV reads from stdin. This gives the possibility of piping the output from gunzip in the case that DASDCONV was generated without gzip support.
- outfile** The name of the AWSCKD image file to be created.

8.9.4 Examples

Example 1:

Convert a .gz compressed DASD image file to AWSCKD format. Create a large file (> 2 GB) and replace the output file if it already exists.

```
DASDCONV -r -lfs D:\MVS\DASD\MVSRES.GZ D:\MVS\DASD\MVSRES.CKD
```

8.9.5 Sample Utility Output

Sample 1:

Convert a .gz compressed DASD image file to AWSCKD format. Create a large file (> 2 GB) and replace the output file if it already exists.

```
D:\HERCULES>DASDCONV -r -lfs D:\MVS\DASD\MVSRES.GZ D:\MVS\DASD\MVSRES.CKD
Hercules DASD CKD image conversion program
Version 3.05
(c)Copyright 1999-2005 by Roger Bowler, Jan Jaeger, and others
Converting 3390 volume MVSRES: 3339 cyls, 15 trks/cyl, 56832 bytes/track
3339 cylinders successfully written to file MVSRES.ckd
DASD conversion successfully completed.
```

Figure 208: DASDCONV utility output

8.10 DASDCOPY (Copy DASD file to another DASD file)

8.10.1 Function

The DASDCOPY utility is used to copy a DASD image file to another DASD image file.

8.10.2 Syntax

Descriptive

```
DASDCOPY [-option [-option ... ]] infile [SF=shadowfile] outfile
```

Diagram

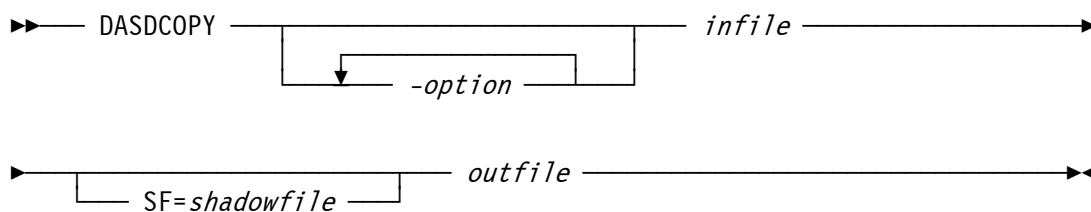

8.10.3 Parameter

Options:

- v** Display version information and help text.
- h** Display usage summary and quit.
- q** Quiet mode, do not display status.
- r** Replace the output file if it already exists.
- z** Compress output using zlib (default).
- bz2** Compress output using bzip2.
- 0** Do not compress output (0 = zero).
- blks *n*** Size of output FBA file.
- cyls *n*** Size of output CKD file.
- a** Output CKD file will have alternate cylinders.
- lfs** Output CKD file will be a single file even if it exceeds 2 GB in size.
- o *type*** Output file type (CKD, CCKD, FBA, CFBA).

Arguments:

infile The input DASD file.
shadowfile The (optional) name of an associated shadow DASD file.
outfile The output DASD file.

8.10.4 Examples

Example 1:

Copy the compressed DASD file (CCKD) MVSRES.148 to SARESX.148, uncompress it (CKD file) and replace an already existing file with the same name.

```
DASDCOPY -r -lfs D:/MVS/DASD/MVSRES.148 D:/MVS/DASD/MVSRESX.148
```

Example 2:

Copy the compressed DASD file (CCKD) MVSRES.148 to SARESX.148, uncompress it (CKD file) and create 2 separate files for systems which do not support large file support.

```
DASDCOPY D:/MVS/DASD/MVSRES.148 D:/MVS/DASD/MVSRESX.148
```

8.10.5 Sample Utility Output

Sample 1:

Copy the DASD image file MVSRES.148 to the new DASD image file SARESX.148. Do not create a large image file (> 2 GB), create two separate files instead.

```
D:\HERCULES>dasdcopy D:/MVS/DASD/MVSRES.148 D:/MVS/DASD/SARESX.148
HHCDU044I Creating 3390 volume : 3339 cyls, 15 trks/cyl, 56832 bytes/track
HHCDU041I 2519 cylinders successfully written to file D:/MVS/DASD/SARESX_1.148
HHCDU041I 820 cylinders successfully written to file D:/MVS/DASD/SARESX_2.148
/ 100% 50085 of 50085
HHCDC010I Copy successful !!!
```

Figure 209: DASDCOPY utility output

8.11 DASDINIT (DASD image file creation)

8.11.1 Function

The Hercules DASD image file creation program (DASDINIT) is used to create an empty DASD image file.

8.11.2 Syntax

Descriptive

```
DASDINIT [-option [-option ... ]] filename devtype[-mode] volser [size]
```

Diagram

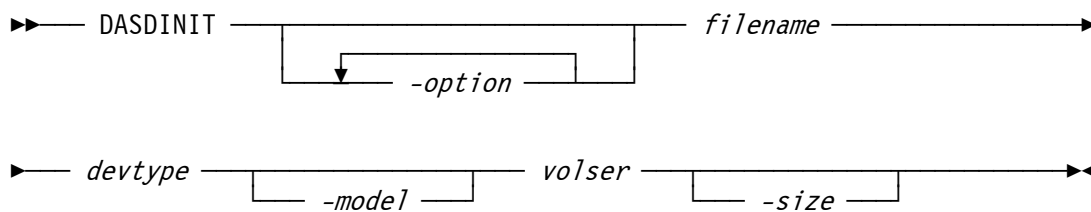

8.11.3 Parameter

Options:

- v** Display version information and help text.
- z** Build compressed DASD image file using zlib.
- bz2** Build compressed DASD image file using bzip2.
- 0** Build compressed DASD image file with no compression (0 = zero).
- lfs** Build a large (uncompressed) DASD file (single file), if it is supported on the platform DASDINIT is running on.
- a** Build a DASD image file that includes alternate cylinders. This option is ignored if the size is manually specified.
- r** Build raw DASD image file (no VOL1 or IPL track).
- linux** Null track images will look like Linux DASDFMT'ed images (3390 device type only).

Arguments:

filename Name of DASD image file to be created.

devtype	FBA: 0671, 3310, 3370, 9313, 9332, 9335, 9336 CKD: 2311, 2314, 3330, 3340, 3350, 3375, 3380, 3390, 9345 A complete list of all Hercules supported DASD device types and models can be found in Appendix A.
model	Device model (Note – this implies size). A list of Hercules supported device types and models can be found in Appendix A.
volser	Volume serial number (1-6 characters).
size	Number of CKD cylinders or 512-byte FBA sectors (required if model not specified, otherwise optional).

For CKD volumes which exceed 2GB, such as the 3390-3, if the *-lfs* parameter is not specified the DASDINIT program will create multiple files by appending the characters *_1*, *_2*, *_3* etc. to the file name specified on the command line. These characters are inserted before the first dot (.) occurring after the last slash (/). If there is no dot then the characters are appended to the end of the name. Each file contains a whole number of cylinders. Hercules CKD support recognizes the files as belonging to a single logical volume. Specify the full name of just the first file in the Hercules configuration file (e.g. "filename_1").

The DASDINIT program cannot create FBA volumes exceeding 2GB unless the *-lfs* parameter is specified and large file size is supported on your platform.

8.11.4 Examples

Example 1:

Create a 3390 Model 3 with volume serial USR001, the file(s) should be named USR001.300 and place them into directory D:\MVS\DASD\. Note that the utility creates actually two files called USR001_1.300 and USR001_2.300 because no large file support is requested.

```
DASDINIT D:\MVS\DASD\USR001.300 3390-3 USR001
```

Example 2:

Create the same DASD volume as in the previous example but create just one file (large file support) named USR001.300 in the same directory.

```
DASDINIT -lfs D:\MVS\DASD\USR001.300 3390-3 USR001
```

Example 3:

Create a 3390 Model 3 with volume serial SYS3A0 and alternate cylinder(s), the file should be compressed with ZLIB and the filename has to be TSTVOL.DSD. The DASD volume must be placed in directory D:\MVS\DASD\.

```
DASDINIT -z -a D:\MVS\DASD\TSTVOL.DSD 3390-3 SYS3A0
```

8.11.5 Sample Utility Output

Sample 1:

Create a 3390 model 3 DASD image file named SYS3A0.3A0 with volser=SYS3A0.

```
D:\HERCULES>DASDINIT D:\MVS\DASD\SYS3A0.3A0 3390-3 SYS3A0
HHCDU044I Creating 3390 volume SYS3A0: 3339 cyls, 15 trks/cyl, 56832 bytes/track
HHCDU041I 2519 cylinders successfully written to file D:/MVS/DASD/SYS3A0_1.3A0
HHCDU041I 820 cylinders successfully written to file D:/MVS/DASD/SYS3A0_2.3A0
HHCDI001I DASD initialization successfully completed.
```

Figure 210: DASDINIT utility output

8.12 DASDISUP (Fix XCTL tables in SVCLIB)

8.12.1 Function

The DASDISUP utility fixes the XCTL tables in SVCLIB on OS/360 systems. On an OS/360 system the OPEN / CLOSE / EOVS modules in SYS1.SVCLIB have XCTL tables embedded within them. These tables contain TTRs, pointing to other modules, and these TTRs need to be adjusted after loading SVCLIB to DASD.

OS/360 provides a program called IEHIOSUP to perform this function, however the issue is that you cannot run IEHIOSUP until you have the system up and running, and you cannot IPL the system until you have fixed the XCTL tables.

To circumvent this problem Hercules provides a utility program called DASDISUP which can be run from the Unix or Windows command line after running DASDLOAD and fixes the XCTL tables.

Note: Do not use this procedure except on OS/360 IPL volumes; other operating systems do not have XCTL tables.

8.12.2 Syntax

Descriptive

DASDISUP *outfile* [SF=*shadowfile*]

Diagram

```
▶▶ — DASDISUP — outfile — [ SF=shadowfile ] — ▶▶
```

8.12.3 Parameter

outfile The name of the OS/360 IPL volume to be updated.

shadowfile The (optional) name of the associated shadow DASD file.

8.12.4 Examples

Example 1:

Fix the XCTL tables in SVCLIB on volume OS36IP.148.

```
DASDISUP D:/MVS/DASD/OS36IP.148
```

8.12.5 Sample Utility Output

Sample 1:

Fix the XCTL tables in SVCLIB on volume OS36IP.148.

```
D:\HERCULES>dasdisup D:/MVS/DASD/OS36IP.148
Hercules IEHIOSUP program Version 3.05
(c)Copyright 1999-2005 by Roger Bowler, Jan Jaeger, and others
HHCDS006W Member IGG019PZ is not single text record
HHCDS006W Member IGG019V6 is not single text record
HHCDS007W Member IGG019V6 size 0A20 exceeds X'7F8' bytes
HHCDS002I End of directory: 4 members selected
HHCDS010I Member IGG019PX skipped
HHCDS010I Member IGG019PY skipped
HHCDS010I Member IGG019PZ skipped
HHCDS010I Member IGG019V6 skipped
```

Figure 211: DASDISUP utility output

8.13 DASDLOAD (DASD loader program)

8.13.1 Function

The Hercules DASD loader program is used to create new DASD file images and load them with data from unloaded PDS files (e.g. a list of TSO XMIT files or a sequential file).

8.13.2 Syntax

Descriptive

```
DASDLOAD [-option [-option ... ]] ctlfile outfile msglevel
```

Diagram

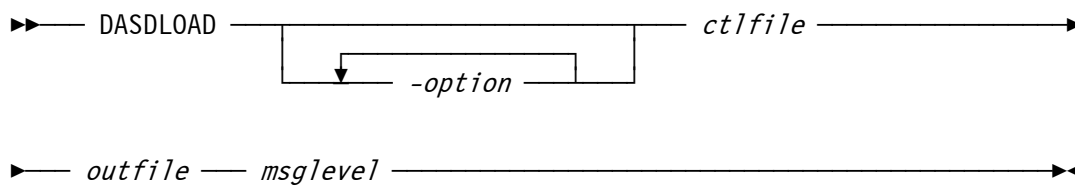

8.13.3 Parameter

Options:

- z** Build compressed DASD image file using zlib.
- bz2** Build compressed DASD image file using bzip2.
- 0** Build compressed DASD image file with no compression (0 = zero).
- lfs** Build a large DASD image file (can exceed 2 Gb in size).
- a** Build DASD image file that includes alternate cylinders.

Arguments:

- ctlfile** This is the name of the control file that specifies the datasets to be loaded onto the newly created volume.
- outfile** The name of the DASD image file to be created.
- msglevel** Msglevel can be a number from 0 to 5, it controls the detail level of messages issued during the load.

8.13.4 Control File

The control file required by the DASDLOAD program is an ASCII text file consisting of a *volume statement* followed by one *dataset statement* for each dataset to be created.

8.13.4.1 Volume Statement

Descriptive

```
volser devtype[-model] [cyls [ipltext]]
```

Diagram

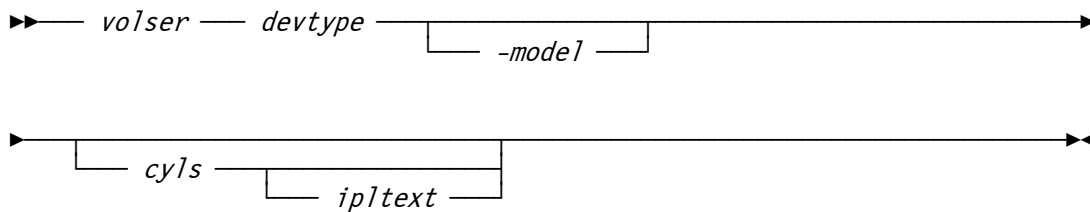

where:

- volser** Volser is the volume serial number of the newly created volume.
- devtype** This specifies the emulated device type (2311, 3330, 3350, 3375, 3380, 3390) of the new volume. FBA device types are not supported by the DASDLOAD program. A list of Hercules supported device types and models can be found in Appendix A.
- model** This specifies the device model. The model implies the size of the volume. A list of Hercules supported device types and models can be found in Appendix A.
- cyls** Cyls specifies the size of the new volume in cylinders. If *cyls* is coded as "*" (asterisk), as "0" or is omitted, then the default size for the device type and model is used. Cylinders is ignored for compressed devices.
- ipltext** An optional parameter specifying the name of a file containing the IPL text which will be written to the volume. The file must be in the form of an object deck containing fixed length 80-byte records in the same format as expected by IBCDASDI or ICKDSF.

8.13.4.2 Dataset Statement

Descriptive

```
dsname method units pri sec dir dsorg recfm lrecl blksize keylen
```

Diagram

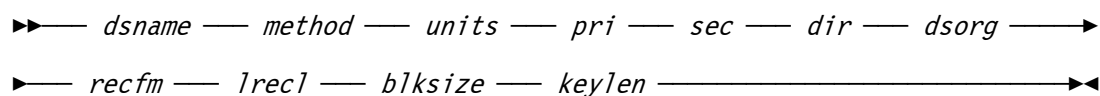

where:

dsname	The name of the dataset to be created.
method	The dataset loading method can be one of the following:
XMIT filename	The dataset is loaded from an unloaded PDS created by the TSO XMIT command.
SEQ filename	The dataset is loaded from a binary file. ASCII / EBCDIC conversion is not currently supported. Also the DSORG must be PS or DA and RECFM must either be F or FB.
EMPTY	The dataset is initialized with an end-of-file record (if DSORG is PS) or is an empty PDS directory (if DSORG is PO).
DIP	The dataset is initialized with a LOGREC header record.
CVOL	The dataset is initialized as an OS SYSCTLG containing the minimum entries needed to IPL an OS/360 system.
VTOC filename	Specifies the size and location of the VTOC. A dataset name must be coded on this statement although it is not used. If no VTOC statement is present, the VTOC will be placed after the last dataset on the volume and the size of the VTOC will be the minimum number of tracks necessary.
units	This specifies the space allocation units: TRK or CYL .
pri	This is the space allocation primary quantity.
sec	This is the space allocation secondary quantity.
dir	This is the number of directory blocks.
dsorg	This specifies the dataset organization: PS , PO , DA or IS .
recfm	This is the record format: F , FB , FBS , V , VB , VBS or U .
lrecl	This is the logical record length.
blksize	This is the block size.
keylen	This is the key length.

All parameters except the *dsname* and *method* are optional. Defaults of zero are supplied for DCB parameters. For datasets loaded with the XMIT method the DCB parameters are taken from the unloaded PDS, minimum space allocation required to load the dataset is used unless a larger quantity is specified. If space allocation is omitted the default is **TRK 1 0 0**. If CYL is specified without any primary quantity then the default allocation is 1 cylinder or the minimum number of cylinders required to load the dataset, whichever is larger.

8.13.5 Examples

Example 1:

Create a 2314 volume in a file called SYSRES.230 using the control file SYSRES.PLF with message level 2.

```
DASDLOAD SYSRES.PLF SYSRES230 2
```

The corresponding control file SYSRES.PLF looks like the following:

```
# Pack layout file for MFT system residence volume
sysres 2314 * ieaipl00.rdr
sys1.parmlib      xmit      /cdrom/os360/reslibs/parmlib.xmi
sys1.imagelib    xmit      /cdrom/os360/reslibs/imagelib.xmi
sysctlg          cvol      trk 1 0 0      ps f 256 256 8
sysvtoc          vtoc      trk 5
sys1.logrec      dip      trk 1 0 0
sys1.nucleus     xmit      /cdrom/os360/reslibs/nucleus.xmi cyl
sys1.svclib      xmit      /cdrom/os360/reslibs/svclib.xmi cyl
sys1.sysjobqe    empty     cyl 2 0 0      da f 176 176 0
sys1.dump        empty     cyl 10 0 0     ps u 0 3625 0
```

Example 2:

Create a compressed 3390-3 volume in a file called LINUX.500 containing a bootable linux system for Linux/390 installation using the control file LINUX.PRM with message level 5.

```
DASDLOAD -z LINUX.PRM LINUX.500 5
```

The corresponding control file LINUX.PRM looks like the following:

```
#
# Build a bootable linux disk
# [Note: the dataset names (sys1.linux. ...) are hard-coded in
#       linuxipl.obj and cannot be changed without rebuilding it]
#
linux 3390-3 * linuxipl.obj
sys1.linux.parmfile SEQ images/redhat.prm trk 1 0 0 ps fb 1024 1024
sys1.linux.tapeipl.ikr SEQ images/kernel.img trk 200 0 0 ps fb 1024 1024
sys1.linux.initrd SEQ images/initrd.img trk 200 0 0 ps fb 1024 1024
```

8.13.6 Sample Utility Output

Sample 1:

Create a 3390 model 3 in a compressed file called TST001.A80 containing 3 libraries (which have been downloaded from CBT tape as XMIT files) using the control file TST001.DAT with message level 1.

The control file TST001.DAT looks like follows:

```
TST001 3390-3 *
SYS2.RACF.UTIL      XMIT      D:\MVS\DASD\CBT728.XMI
SYS2.BATCH.CNTL    XMIT      D:\MVS\DASD\CBT357.XMI
SYS2.PL1.SAMPLES   XMIT      D:\MVS\DASD\CBT316.XMI
```

The corresponding output from the utility is the following:

```
D:\HERCULES>DASDLOAD -z D:\MVS\DASD\TST001.DAT D:\MVS\DASD\TST001.A80 1
Hercules DASD loader program Version 3.05
(c)Copyright 1999-2005 by Roger Bowler, Jan Jaeger, and others
----- TST001 3390-3 *
HHCDL006I Creating 3390 volume TST001: 15 trks/cyl, 56832 bytes/track
HHCDU044I Creating 3390 volume TST001: 3339 cyls, 15 trks/cyl, 56832 bytes/track
HHCDU041I 3339 cylinders successfully written to file D:\MVS\DASD\TST001.A80
HHCDL009I Loading 3390 volume TST001
----- SYS2.RACF.UTIL      XMIT      D:\MVS\DASD\CBT728.XMI
HHCDL012I Creating dataset SYS2.RACF.UTIL at cyl 0 head 1
HHCDL110I Processing file D:\MVS\DASD\CBT728.XMI
----- SYS2.BATCH.CNTL    XMIT      D:\MVS\DASD\CBT357.XMI
HHCDL012I Creating dataset SYS2.BATCH.CNTL at cyl 0 head 2
HHCDL110I Processing file D:\MVS\DASD\CBT357.XMI
----- SYS2.PL1.SAMPLES   XMIT      D:\MVS\DASD\CBT316.XMI
HHCDL012I Creating dataset SYS2.PL1.SAMPLES at cyl 10 head 0
HHCDL110I Processing file D:\MVS\DASD\CBT316.XMI
HHCDL057I VTOC starts at cyl 21 head 10 and is 1 track
HHCDL014I Free space starts at cyl 21 head 11
HHCDL016I Total of 3339 cylinders written to D:\MVS\DASD\TST001.A80
```

Figure 212: DASDLOAD utility output (XMIT method, message level 1)

Sample 2:

Create a 3390 model 3 in a compressed file called TST001.A80 containing a library contained in a XMIT files using the control file TST001.DAT with message level 3.

The control file TST001.DAT looks like follows:

```
TST001 3390-3 *
SYS2.RACF.UTIL      XMIT      D:\MVS\DASD\CBT728.XMI
```

The corresponding output from the utility is the following:

```
D:\HERCULES>DASDLOAD -z D:\MVS\DASD\TST001.DAT D:\MVS\DASD\TST001.A80 3
Hercules DASD loader program Version 3.05
(c)Copyright 1999-2005 by Roger Bowler, Jan Jaeger, and others
----- TST001 3390-3 *
HHCDL006I Creating 3390 volume TST001: 15 trks/cyl, 56832 bytes/track
HHCDU044I Creating 3390 volume TST001: 3339 cyls, 15 trks/cyl, 56832 bytes/track
HHCDU041I 3339 cylinders successfully written to file D:\MVS\DASD\TST001.A80
HHCDL009I Loading 3390 volume TST001
----- SYS2.RACF.UTIL XMIT D:\MVS\DASD\CBT728.XMI
HHCDL012I Creating dataset SYS2.RACF.UTIL at cyl 0 head 1
HHCDL110I Processing file D:\MVS\DASD\CBT728.XMI
HHCDL078I File 1: DSNAME=SBGOLOB.CBT470.FILE728
HHCDL079I DSORG=PO RECFM=FB LRECL=80 BLKSIZE=5600 KEYLEN=0 DIRBLKS=6
HHCDL084I Original dataset: DSORG=PO RECFM=FB LRECL=80 BLKSIZE=5600 KEYLEN=0
HHCDL085I Dataset was unloaded from device type 3030200F (3390)
HHCDL086I Original device has 2226 cyls and 15 heads
HHCDL095I Member $$$#DATE TTR=000214 Userdata=044600000105311F .....
      0105311F0733000C 000C0000C3C2E360 F4F7F0404040 .....CBT-470
HHCDL095I Member $$NOTE1 TTR=00020E Userdata=010100160105311F .....
      0105311F07330009 000A0000E2C2C7D6 D3D6C2404040 .....SBGOLOB
HHCDL095I Member @FILE728 TTR=000210 Userdata=044600000105311F .....
      0105311F07330005 00050000C3C2E360 F4F7F0404040 .....CBT-470
HHCDL095I Member ICHPWX01 TTR=000109 Userdata=010100000105311F .....
      0105311F0711019A 019A0000D1D6E4E2 D4C140404040 .....JOUSMA
HHCDL090I End of directory
HHCDL013I Dataset SYS2.RACF.UTIL contains 1 track
HHCDL057I VTOC starts at cyl 0 head 2 and is 1 track
HHCDL014I Free space starts at cyl 0 head 3
HHCDL016I Total of 3339 cylinders written to D:\MVS\DASD\TST001.A80
```

Figure 213: DASDLOAD utility output (XMIT method, message level 3)

Sample 3:

Create a 3390 model 3 in a compressed file called TST001.A80 containing a sequential file using the control file TST001.DAT with message level 5.

The control file TST001.DAT looks like follows:

```
TST001 3390-3 *
SYS2.SEQ.DATA SEQ D:\MVS\DASD\SEQ.BIN TRK 5 5 0 PS FB 80 3120
```

The corresponding output from the utility is the following:

```
D:\HERCULES>dasdload -z D:\MVS\DASD\TST001.DAT D:\MVS\DASD\TST001.A80 5
Hercules DASD loader program Version 3.05
(c)Copyright 1999-2005 by Roger Bowler, Jan Jaeger, and others
----- TST001 3390-3 *
HHCDL006I Creating 3390 volume TST001: 15 trks/cyl, 56832 bytes/track
HHCDU044I Creating 3390 volume TST001: 3339 cyls, 15 trks/cyl, 56832 bytes/track
HHCDU041I 3339 cylinders successfully written to file D:\MVS\DASD\TST001.A80
HHCDL009I Loading 3390 volume TST001
----- SYS2.SEQ.DATA SEQ D:\MVS\DASD\SEQ.BIN TRK 5 5 0 PS FB 80 3120
HHCDL012I Creating dataset SYS2.SEQ.DATA at cyl 0 head 1
HHCDL013I Dataset SYS2.SEQ.DATA contains 5 tracks
-----
HHCDL057I VTOC starts at cyl 0 head 6 and is 1 track
HHCDL058I Format 4 DSCB CCHHR=0000000601 (TTR=000001)
+0000 00000000 00000000 00000000 04040404 .....
+0010 04040404 04040404 04040404 04040404 .....
Line 0020 same as above
+0030 04040404 04040404 F4000000 0603002F .....4...../
+0040 0D0B0000 00008001 00000D0B 000FE5A2 .....Vs
+0050 00000030 0000322D 00000000 00000000 ...0..2-.....
+0060 00000000 00000000 00000000 00000000 .....
+0070 00000000 00010000 00000600 00000600 .....
+0080 00000000 00000000 00000000 00000000 .....
+0090 00000000 00000000 .....
HHCDL058I Format 5 DSCB CCHHR=0000000602 (TTR=000002)
+0000 00000000 00000000 00000000 05050505 .....
+0010 00000000 00000000 00000000 00000000 .....
Line 0020 same as above
+0030 00000000 00000000 F5000000 00000000 .....5.....
+0040 00000000 00000000 00000000 00000000 .....
Lines 0050 to 0080 same as above
+0090 00000000 00000000 .....
HHCDL058I Format 1 DSCB CCHHR=0000000603 (TTR=000003) SYS2.SEQ.DATA
+0000 00000000 00000000 00000000 E2E8E2F2 .....SYS2
+0010 4BE2C5D8 4BC4C1E3 C1404040 40404040 .SEQ.DATA
+0020 40404040 40404040 40404040 40404040
+0030 40404040 40404040 F1E3E2E3 F0F0F100 1TST001.
+0040 016A002C 00000001 4000C8C5 D9C3E4D3 .|.,.... .HERCUL
+0050 C5E24040 40404000 00000000 00004000 ES ..... .
```

```
+0060 90000C30 00500000 00A08000 00050000 ...0.&.....
+0070 02DCDE00 00010000 00000100 00000500 .....
+0080 00000000 00000000 00000000 00000000 .....
+0090 00000000 00000000 .....
HHCDL059I Format 0 DSCB CCHHR=0000000604 (TTR=000004)
HHCDL059I Format 0 DSCB CCHHR=0000000605 (TTR=000005)
.
.
.
several lines not displayed
.
.
.
HHCDL059I Format 0 DSCB CCHHR=0000000631 (TTR=000031)
HHCDL059I Format 0 DSCB CCHHR=0000000632 (TTR=000032)
HHCDL014I Free space starts at cyl 0 head 7
HHCDL016I Total of 3339 cylinders written to D:\MVS\DASD\TST001.A80
HHCDL017I Updating VTOC pointer 0000000601
```

Figure 214: DASDLOAD utility output (SEQ method, message level 5)

8.14 DASDLS (List datasets on a volume)

8.14.1 Function

The DASDLS utility is used to list all datasets on the specified DASD image file.

8.14.2 Syntax

Descriptive

```
DASDLS filename [SF=shadowfile]
```

Diagram

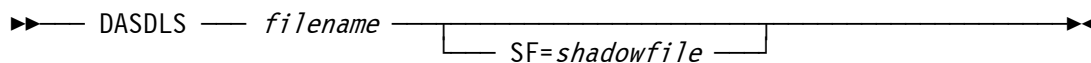

8.14.3 Parameter

filename Name of the DASD image file for which the datasets contained will be listed.

shadowfile Optional name of an associated shadow file (s) from which any datasets will be listed.

8.14.4 Examples

Example 1:

List all the datasets currently on the volume D:\MVS\DASD\MVSRES.148.

```
DASDLS D:\MVS\DASD\MVSRES.148
```

8.14.5 Sample Utility Output

Sample 1:

List all the datasets currently on the volume D:\MVS\DASD\MVSRES.148.

```
D:\Hercules>dasdls D:\MVS\DASD\MVSRES.148c  
Hercules DASD list program Version 3.05  
(c)Copyright 1999-2006 by Roger Bowler, Jan Jaeger, and others  
D:\MVS\DASD\MVSRES.148c: VOLSER=MVSRES  
Z9999994.VSAMDSPC.T8386AEA.TE8EE610  
SYS1.STAGE1.OUTPUT  
SYS1.LPALIB  
SYS1.LINKLIB
```

```
SYS1.SVCLIB  
SYS1.NUCLEUS  
SYS1.DCMLIB  
SYS1.INDMAC  
SYS1.CMDLIB  
SYS1.HELP  
SYS1.SAMPLIB  
SYS1.MACLIB  
SYS1.PROCLIB  
SYS1.TELCMLIB  
SYS1.UADS  
SYS1.VTAMLIB  
SYS1.IMAGELIB
```

```
.  
. .  
several lines not displayed
```

```
.  
. .  
SYS1.SMPCRQ  
SYS1.SMPSCDS  
SYS1.COBLIB  
SYS1.FORTLIB  
SYS1.PL1LIB  
SYS1.SORTLIB
```

Figure 215: DASDLS utility output

8.15 DASDPDSU (PDS unload utility)

8.15.1 Function

The DASDPDSU utility is a command that unloads PDS members from a DASD image and copies each member to a file *memname.mac* in the current working directory.

8.15.2 Syntax

Descriptive

```
DASDPDSU filename [SF=shadowfile] pdsname [ASCII]
```

Diagram

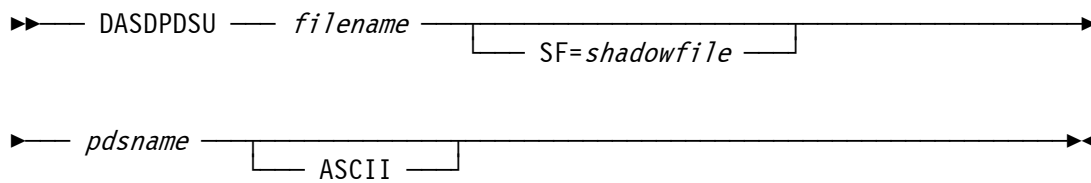

8.15.3 Parameter

- filename** Name of the DASD image file from which a PDS will be unloaded.
- shadowfile** Optional name of an associated shadow file.
- pdsname** Name of the partitioned dataset on the DASD image file from which the members will be unloaded.
- ASCII** If the optional keyword ASCII is specified the members will be unloaded as ASCII variable length text files. Otherwise the members are unloaded as fixed length EBCDIC binary files.

8.15.4 Examples

Example 1:

Unload the dataset "SYS1.PARMLIB" on DASD image file MVSRES.148 in ASCII format.

```
DASDPDSU D:\MVS\DASD\MVSRES.148 SYS1.PARMLIB ASCII
```

8.15.5 Sample Utility Output

Sample 1:

Unload the dataset "SYS1.PARMLIB" on DASD image file MVSRES.148 in ASCII format.

```
D:\Hercules>dasdpdsu D:\MVS\DASD\MVSRES.148 SYS1.PARMLIB ASCII
Hercules PDS unload program Version 3.05
(c)Copyright 1999-2006 by Roger Bowler, Jan Jaeger, and others
Reading directory block at cyl 198 head 0 rec 1
Member COMMND00 TTR=001A27
Member GTFPARG TTR=001A33
Member IEAABD00 TTR=001A35
Member IEAAPF00 TTR=001A29
Member IEABLD00 TTR=001B0C
Member IEADMP00 TTR=001A31
Reading directory block at cyl 198 head 0 rec 2
Member IEADMR00 TTR=001A2F
Member IEAIPS00 TTR=000112
Member IEALOD00 TTR=000712
Member IEAOPT00 TTR=000126
Member IEAPAK00 TTR=00062E
Member IEASYS00 TTR=002D2E
Member IPCSPR00 TTR=00041B
Member IRBMF100 TTR=001B1E
Member JES2PARG TTR=003C07
Reading directory block at cyl 198 head 0 rec 3
Member LNKLST00 TTR=001804
Member MVIKEY00 TTR=001B12
Member RPFKEY00 TTR=000B42
Member SMFPRM00 TTR=001B3B
Member TSOKEY00 TTR=001B14
Member VATLST00 TTR=001B45
End of directory
```

Figure 216: DASDPDSU utility output

8.16 DASDSEQ (Display sequential datasets)

8.16.1 Function

The DASDSEQ utility is used to extract and list sequential datasets from a DASD image file.

8.16.2 Syntax

Descriptive

```
DASDSEQ [-DEBUG] [-EXPERT] [-ASCII] image [SF=shadowfile] filespec
```

Diagram

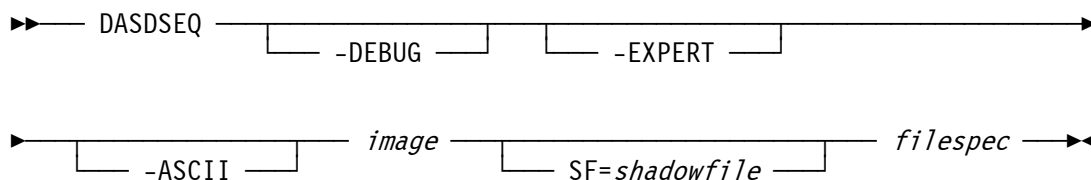

8.16.3 Parameter

Options:

- DEBUG** Display additional debug options.
- EXPERT** Display an additional help panel that describes the expert operands.
- ASCII** Translate the output file to ASCII and trim trailing blanks.

Arguments:

- image** The file name (and optionally path) of the DASD image file.
- shadowfile** The optional name (and path) of an associated shadow file.
- filespec** The name of a sequential dataset (DSORG=PS) on the DASD image file. This name is also used as filename for the extracted data.

All expert facilities (as described in the -EXPERT help panel) are experimental and therefore not yet described here.

8.16.4 Examples

Example 1:

Extract and list the sequential dataset SYS2.SEQ.DATA on the DASD image file TST001.AA0.

```
DASDSEQ -ASCII D:\MVS\DASD\TST001.AA0 D:\MVS\DASD\SYS2.SEQ.DATA
```

8.16.5 Sample Utility Output

Sample 1:

Extract and list the sequential dataset SYS2.SEQ.DATA on the DASD image file TST001.AA0.

```
D:\HERCULES>dasdseq -ascii D:\MVS\DASD\TST001.AA0 SYS2.SEQ.DATA
dasdseq 3.05 Copyright 1999-2005 Roger Bowler
Portions Copyright 2001-2005 James M. Morrison
dasdseq wrote 11 records to SYS2.SEQ.DATA
```

Figure 217: DASDSEQ utility output

8.17 HETGET (Extract files from an AWS or HET tape file)

8.17.1 Function

The HETGET utility extracts a file from an AWSTAPE or HET tape file. The output is in binary format and has to be displayed with an EBCDIC editor on the PC or has to be uploaded to the host operating system and opened with a mainframe editor.

8.17.2 Syntax

Descriptive

HETGET *tapfile outfile filenum*

Diagram

▶— HETGET — *tapfile* — *outfile* — *filenum* —▶

8.17.3 Parameter

- tapfile** The name (and optionally the path) of the AWSTAPE or HET tape file from which a file should be extracted.
- outfile** The name (and optionally the path) of the file to which the extracted file will be written.
- filenum** The file number on the tape of the file to be extracted from the tape.

8.17.4 Examples

Example 1:

Extract file number 25 from the AWSTAPE file named T001003.AWS and write it to file FILE#25.BIN in directory D:/S390/UNLOAD/.

```
HETGET D:/MVS/TAPE/T001003.AWS D:/S390/UNLOAD/FILE#25.BIN 25
```

8.17.5 Sample Utility Output

Sample 1:

Extract file number 10 from the AWSTAPE file named T38321A.AWS and write it to file FILE10.BIN.

```
D:\HERCULES>hetget D:/MVS/TAPE/T38321A.AWS D:/FILE10.BIN 10
Hercules HET extract files program Version 3.05
(c)Copyright 1999-2005 by Roger Bowler, Jan Jaeger, and others
File Info:
  DSN=BBC.BBC53XX.F5
DCB Attributes used:
  RECFM=V      LRECL=32756  BLKSIZE=32760
```

Figure 218: HETGET utility output

8.18 HETINIT (Initialize an AWS or HET tape file)

8.18.1 Function

The HETINIT utility is used to initialize a tape file.

8.18.2 Syntax

Descriptive

```
HETINIT [-option [-option ... ]] filename [volser] [owner]
```

Diagram

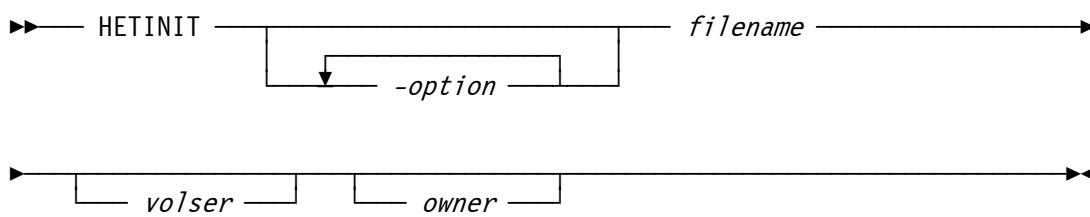

8.18.3 Parameter

Options:

- d Disable compression (creates an AWSTAPE file).
- h Display usage summary (help text).
- i Create an IEHINITT formatted tape (set on by default!).
- n Create a NL (non labeled) tape.

Arguments:

- filename** Name (and optionally path) of the tape file to be created.
- volser** The volser of the tape.
- owner** The owner of the tape.

8.18.4 Examples

Example 1:

Create a new AWS tape file named NEWTAPE.AWS with volser NEWTAP and owner HERCULES in the directory D:/MVS/TAPE/.

```
HETINIT -d D:/MVS/TAPE/NEWTAPE.AWS NEWTAP HERCULES
```

8.18.5 Sample Utility Output

Sample 1:

Create a new HET tape file named NEWTAPE.HET with volser NEWTAP and owner HERCULES in the directory D:/MVS/TAPE/.

```
D:\HERCULES>hetinit D:/MVS/TAPE/NEWTAPE.HET NEWTAP HERCULES
Hercules HET IEHINITT program Version 3.05
(c)Copyright 1999-2005 by Roger Bowler, Jan Jaeger, and others
```

Figure 219: HETINIT utility output

8.19 HETMAP (Show information about a HET or AWS tape file)

8.19.1 Function

The Hercules HETMAP program displays information about a HET or an AWSTAPE tape file. By default, HETMAP shows label and file information. Optionally, HETMAP may be used to display data set information, or to display label information in a format similar to the output of TAPEMAP. HETMAP shows information about the tape and files on it, and does not display actual file contents.

8.19.2 Syntax

Descriptive

```
HETMAP [-option [-option ... ]] filename
```

Diagram

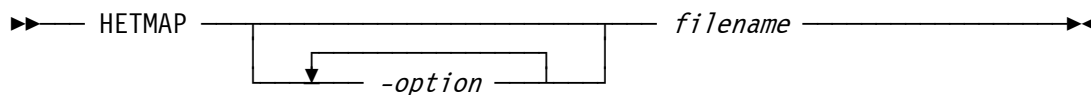

8.19.3 Parameter

Options:

- a** Print all label and file information (default).
- d** Print only dataset information.
- f** Print only file information.
- h** Display usage summary.
- l** Print only label information.
- t** Print TAPEMAP-compatible format output.

Options are mutually exclusive. If more than one option is entered, the last one is used. If no options are specified, "-a" is the default.

Arguments:

- filename** The name (and optionally path) of the HET or AWS tape file about which information is to be displayed.

8.19.4 Examples

Example 1:

Show information about a HET tape file.

```
HETMAP D:/MVS/TAPE/RPF142.HET
```

8.19.5 Sample Utility Output

Sample 1:

Show information about a HET tape file (print all label and file information).

```
D:\Hercules>hetmap -a G:\MVS\TAPE\RPF142.HET
Hercules HET and AWS tape map program Version 3.0.7
(c)Copyright 1999-2009 by Roger Bowler, Jan Jaeger, and others
-----
Filename           : G:\MVS\TAPE\RPF142.HET
-----
Label              : 'VOL1'
Volume Serial      : 'RPF142'
Improved Data Rec. : ' '
Owner Code         : ' '
-----
Label              : 'HDR1'
Dataset ID         : 'RPF.INST.SRPFASM '
Volume Serial      : 'RPF142'
Volume Sequence    : '0001'
Dataset Sequence   : '0001'
GDG Number         : ' '
GDG Version        : ' '
Creation Date      : ' 74186'
Expiration Date    : ' 00000'
Dataset Security   : '0'
Block Count Low    : '000000'
System Code        : 'IBM OS/VS 370'
Block Count High   : ' '
-----
Label              : 'HDR2'
Record Format       : 'V'
Block Size         : '19060'
Record Length      : '19056'
Density           : '4'
Dataset Position   : '0'
Job/Step ID        : 'HERC01 /UNLOAD '
Recording Technique : ' '
Control Character  : ' '
Block Attribute    : 'S'
Device Serial      : ' 30001'
Checkpoint ID      : ' '
Large Block Length : ' '
-----
File #             : 1
Blocks             : 3
```

```

Min Blocksize      : 80
Max Blocksize      : 80
Uncompressed bytes : 240
Min Blocksize-Comp : 23
Max Blocksize-Comp : 68
Compressed bytes   : 145
-----
File #             : 2
Blocks             : 196
Min Blocksize      : 20
Max Blocksize      : 19060
Uncompressed bytes : 2907140
Min Blocksize-Comp : 20
Max Blocksize-Comp : 4739
Compressed bytes   : 579020
-----
Label              : 'EOF1'
Dataset ID         : 'RPF.INST.SRPFASM '
Volume Serial      : 'RPF142'
Volume Sequence    : '0001'
Dataset Sequence   : '0001'
GDG Number         : ' '
GDG Version        : ' '
Creation Date      : ' 74186'
Expiration Date    : ' 00000'
Dataset Security   : '0'
Block Count Low    : '000196'
System Code        : 'IBM OS/VS 370'
Block Count High   : ' '
-----
Label              : 'EOF2'
Record Format       : 'V'
Block Size         : '19060'
Record Length      : '19056'
Density           : '4'
Dataset Position   : '0'
Job/Step ID        : 'HERC01 /UNLOAD '
Recording Technique : ' '
Control Character   : ' '
Block Attribute    : 'S'
Device Serial      : ' 30001'
Checkpoint ID      : ' '
Large Block Length : ' '
-----
.
.
.
-----
File #             : 15
Blocks             : 2
Min Blocksize      : 80
Max Blocksize      : 80
Uncompressed bytes : 160
Min Blocksize-Comp : 54
Max Blocksize-Comp : 73

```



```
Compressed bytes      : 127
```

```
-----
```

```
File #                : 16
```

```
Blocks                : 0
```

```
Min Blocksize        : 0
```

```
Max Blocksize        : 0
```

```
Uncompressed bytes   : 0
```

```
Min Blocksize-Comp   : 0
```

```
Max Blocksize-Comp   : 0
```

```
Compressed bytes     : 0
```

```
-----
```

```
Summary              :
```

```
Files                 : 16
```

```
Blocks                : 425
```

```
Uncompressed bytes   : 3701156
```

```
Compressed bytes     : 913267
```

```
Reduction             : 2787889
```

Figure 220: HETMAP utility output (print all label and file information)

Sample 2:

Show information about a HET tape file (print only dataset information).

```
G:\Hercules>hetmap -d G:\MVS\TAPE\RPF142.HET
Hercules HET and AWS tape map program Version 3.0.7
(c)Copyright 1999-2009 by Roger Bowler, Jan Jaeger, and others
vol=RPF142          owner=

seq=1              file#=2
dsn=RPF.INST.SRPFASM  crtddt=1974.186  expdt=0000.000  blocks=196
job=HERC01 /UNLOAD  recfm=VS          lrecl=19056     blksize=19060

seq=2              file#=5
dsn=RPF.INST.SRPF0BJ  crtddt=1974.186  expdt=0000.000  blocks=126
job=HERC01 /UNLOAD  recfm=VS          lrecl=3136      blksize=3140

seq=3              file#=8
dsn=RPF.INST.SRPFHELP crtddt=1974.186  expdt=0000.000  blocks=8
job=HERC01 /UNLOAD  recfm=VS          lrecl=19056     blksize=19060

seq=4              file#=11
dsn=RPF.INST.SRPFLOAD crtddt=1974.186  expdt=0000.000  blocks=55
job=HERC01 /UNLOAD  recfm=VS          lrecl=19085     blksize=19089

seq=5              file#=14
dsn=RPF.INST.CNTL    crtddt=1974.186  expdt=0000.000  blocks=19
job=HERC01 /UNLOAD  recfm=VS          lrecl=19056     blksize=19060
```

Figure 221: HETMAP utility output (print only dataset information)

Sample 3:

Show information about a HET tape file in TAPEMAP format.

```
D:\Hercules>hetmap -t D:\MVS\TAPE\RPF142.HET
Hercules HET and AWS tape map program Version 3.0.7
(c)Copyright 1999-2009 by Roger Bowler, Jan Jaeger, and others
VOL1RPF1420
HDR1RPF.INST.SRPFASM RPF14200010001      74186 000000000000IBM OS/VS 370
HDR2V190601905640HERC01 /UNLOAD      S  30001
File 1: Blocks=3, block size min=80, max=80
File 2: Blocks=196, block size min=20, max=19060
EOF1RPF.INST.SRPFASM RPF14200010001      74186 000000000196IBM OS/VS 370
EOF2V190601905640HERC01 /UNLOAD      S  30001
File 3: Blocks=2, block size min=80, max=80
HDR1RPF.INST.SRPF0BJ RPF14200010002      74186 000000000000IBM OS/VS 370
HDR2V031400313640HERC01 /UNLOAD      S  30001
File 4: Blocks=2, block size min=80, max=80
File 5: Blocks=126, block size min=60, max=3140
EOF1RPF.INST.SRPF0BJ RPF14200010002      74186 000000000126IBM OS/VS 370
EOF2V031400313640HERC01 /UNLOAD      S  30001
File 6: Blocks=2, block size min=80, max=80
HDR1RPF.INST.SRPFHELPRPF14200010003      74186 000000000000IBM OS/VS 370
HDR2V190601905640HERC01 /UNLOAD      S  30001
File 7: Blocks=2, block size min=80, max=80
File 8: Blocks=8, block size min=60, max=11232
EOF1RPF.INST.SRPFHELPRPF14200010003      74186 000000000008IBM OS/VS 370
EOF2V190601905640HERC01 /UNLOAD      S  30001
File 9: Blocks=2, block size min=80, max=80
HDR1RPF.INST.SRPFLOADRPF14200010004      74186 000000000000IBM OS/VS 370
HDR2V190891908540HERC01 /UNLOAD      S  30001
File 10: Blocks=2, block size min=80, max=80
File 11: Blocks=55, block size min=20, max=18864
EOF1RPF.INST.SRPFLOADRPF14200010004      74186 000000000055IBM OS/VS 370
EOF2V190891908540HERC01 /UNLOAD      S  30001
File 12: Blocks=2, block size min=80, max=80
HDR1RPF.INST.CNTL   RPF14200010005      74186 000000000000IBM OS/VS 370
HDR2V190601905640HERC01 /UNLOAD      S  30001
File 13: Blocks=2, block size min=80, max=80
File 14: Blocks=19, block size min=60, max=10672
EOF1RPF.INST.CNTL   RPF14200010005      74186 000000000019IBM OS/VS 370
EOF2V190601905640HERC01 /UNLOAD      S  30001
File 15: Blocks=2, block size min=80, max=80
File 16: Blocks=0, block size min=0, max=0
End of tape.
```

Figure 222: HETMAP utility output (TAPEMAP compatible output)

8.20 HETUPD (Update and/or copy an AWS or HET tape file)

8.20.1 Function

The HETUPD utility updates and/or copies emulated tape files.

8.20.2 Syntax

Descriptive

```
HETUPD [-option [-option ... ]] source [destination]
```

Diagram

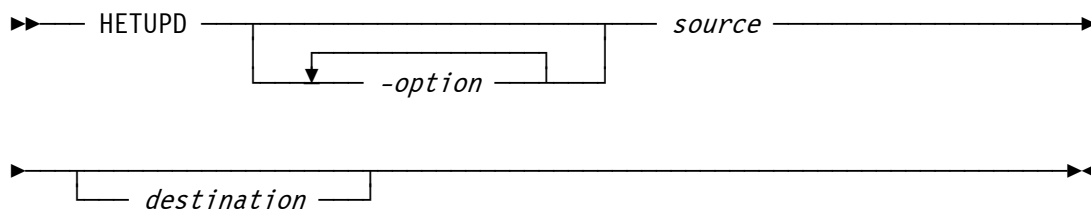

8.20.3 Parameter

Options:

- 1 ... -9** Compression level (1=compress fast, 9=compress best).
- b** Use bzlib compression.
- c *n*** Set chunk size to "n".
- d** Decompress source tape file.
- h** Display usage summary (help text).
- r** Rechunk tape file.
- s** Strict AWSTAPE specification (chunksize=4096, no compression).
- v** Verbose information (display usage summary).
- z** Use zlib compression.

Arguments:

- source** Name (and optionally path) of the source tape file.
- destination** Name (and optionally path) of the destination tape file.

8.20.4 Examples

Example 1:

Create an AWSTAPE file from an existing HET tape file.

```
HETUPD -s D:/MVS/TAPE/T001002.HET D:/MVS/TAPE/T001002.AWS
```

Example 2:

Change the compression level to 2 with BZLIB compression and create a new HET tape file.

```
HETUPD -2 -b D:/MVS/TAPE/TLEV009.HET D:/MVS/TAPE/TLEV002.HET
```

8.20.5 Sample Utility Output

Sample 1:

Change the compression level to 4 (best match between speed and compression rate) and create a new HET tape file.

```
D:\HERCULES>hetupd -4 D:/MVS/TAPE/T38321A.HET D:/MVS/TAPE/T38321B.HET
Hercules HET copy/update program Version 3.05
(c)Copyright 1999-2005 by Roger Bowler, Jan Jaeger, and others
```

Figure 223: HETUPD utility output

8.21 TAPECOPY (Copy a SCSI tape to or from an AWSTAPE disk file)

8.21.1 Function

The Hercules tape copy program copies a SCSI tape to or from an AWSTAPE disk file. Tapcopy reads a SCSI tape and outputs an AWSTAPE file representation of the tape, or reads an AWSTAPE file and creates an identical copy of its contents on a tape mounted on a SCSI tape drive.

If the input file is a SCSI tape it is read and processed until physical EOD (end-of-data) is reached. That is, it does not stop whenever multiple tapemarks or filemarks are read, rather it continues processing until the SCSI tape drive says there is no more data on the tape.

The resulting AWSTAPE output disk file may be specified for the filename on a Hercules tape device configuration statement. It can then be used in order for the Hercules guest O/S to read the exact same data without having a SCSI tape drive physically attached to the host system. This allows you to easily transfer SCSI tape data to other systems that may not have SCSI tape drives attached to them.

The possible return codes and their meaning are:

- 0 Successful completion.
- 1 Invalid arguments or no arguments given.
- 3 Unable to open SCSI tape drive device file.
- 4 Unable to open AWSTAPE disk file.
- 5 Unrecoverable I/O error setting variable length block processing for SCSI tape device.
- 6 Unrecoverable I/O error rewinding SCSI tape device.
- 7 Unrecoverable I/O error obtaining status of SCSI device.
- 8 Unrecoverable I/O error reading block header from AWSTAPE disk file.
- 9 Unrecoverable I/O error reading data block.
- 10 AWSTAPE block size too large.
- 11 Unrecoverable I/O error writing tapemark.
- 12 Unrecoverable I/O error writing block header to AWSTAPE disk file.
- 13 Unrecoverable I/O error writing data block.

8.21.2 Syntax

Descriptive

TAPECOPY [*tapedrive*] [*awsfile*]

or

TAPECOPY [*awsfile*] [*tapedrive*]

Diagram

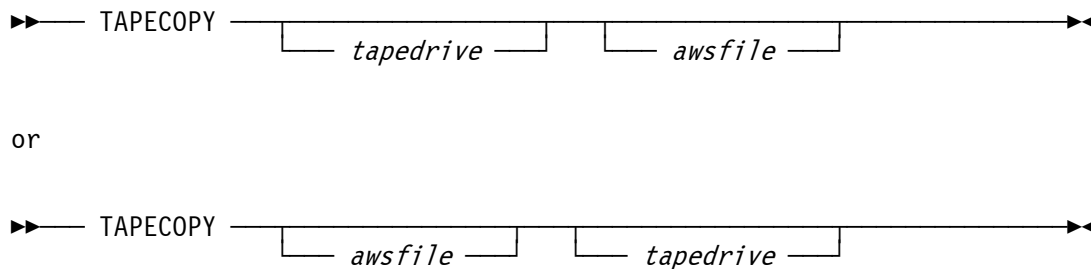

8.21.3 Parameter

- tapedrive** Specifies the device filename of the SCSI tape drive. Must begin with */dev* to be recognized.
- awsfile** Specifies the filename of the AWSTAPE disk file.

The first filename is the input; the second one is the output.

8.21.4 Examples

Example 1:

Copy a SCSI file to an AWSTAPE disk file.

```
TAPECOPY /dev/nst0/scsifile.bin D:/MVS/TAPE/T3832AA.AWS
```

8.21.5 Sample Utility Output

Sample 1:

Copying an AWSTAPE disk file to a SCSI drive (this sample abends because the SCSI drive does not exist).

```
D:\HERCULES>tapecopy D:/T38321A.AWS /dev/nts0/scsifile.bin
Hercules tape copy program Version 3.05
(c)Copyright 1999-2005 by Roger Bowler, Jan Jaeger, and others
HHCTC001E Error opening /dev/nts0/scsifile.bin: errno=22: Invalid argument
HHCTC000I Abnormal termination
```

Figure 224: TAPECOPY utility output

8.22 TAPEMAP (Show information about an AWS tape file)

8.22.1 Function

The TAPEMAP program shows information about an AWS tape. It displays all header data contained on the tape. Please note that the utility does not display the actual contents of the files. Although the TAPEMAP utility does display the same data as the HETMAP utility, the output is formatted in a totally different way.

TAPEMAP produces correct output only for an AWS format tape. Use of TAPEMAP with any tape format other than AWS produces unpredictable results. Do not use it for HET tapes. The HETMAP program displays information about both AWS and HET tapes, and should be used instead of TAPEMAP.

8.22.2 Syntax

Descriptive

TAPEMAP *filename*

Diagram

▶▶ — TAPEMAP — *filename* —————▶▶

8.22.3 Parameter

filename The name (and optionally path) of the AWS tape whose header data is to be displayed.

8.22.4 Examples

Example 1:

Print map of an AWS tape file.

```
TAPEMAP D:/MVS/TAPE/T38321A.AWS
```

8.22.5 Sample Utility Output

Sample 1:

Print map of an AWS tape file.

```
D:\Hercules>tapemap G:\MVS\TAPE\38321A.AWS
Hercules tape map program Version 3.0.7
(c)Copyright 1999-2009 by Roger Bowler, Jan Jaeger, and others
File 1: Blocks=614, block size min=800, max=800
File 2: Blocks=38, block size min=6272, max=6272
File 3: Blocks=90, block size min=160, max=800
File 4: Blocks=29, block size min=720, max=800
File 5: Blocks=113, block size min=80, max=800
File 6: Blocks=1581, block size min=800, max=800
File 7: Blocks=597, block size min=160, max=800
File 8: Blocks=181, block size min=320, max=800
File 9: Blocks=126, block size min=640, max=640
File 10: Blocks=11, block size min=560, max=800
File 11: Blocks=512, block size min=800, max=800
File 12: Blocks=0, block size min=0, max=0
End of tape.
```

Figure 225: TAPEMAP utility output (map AWS tape file)

8.23 TAPESPLT (Split an AWS tape file)

8.23.1 Function

The TAPESPLT utility allows it to split an AWSTAPE file into a new AWSTAPE file. The number of the files to be copied defines the split point.

8.23.2 Syntax

Descriptive

TAPESPLT *infile outfile count*

Diagram

▶— TAPESPLT — *infile* — *outfile* — *count* —▶

8.23.3 Parameter

infile The name of the input AWSTAPE disk file.
outfile The name of the output AWSTAPE disk file.
count The number of files that have to be copied to the output file.

8.23.4 Examples

Example 1:

Copy the first three files from AWSTAPE file TOLDTAP.AWS to the new AWSTAPE file TNEWTAP.AWS.

```
TAPESPLT D:/MVS/TAPE/TOLDTAP.AWS D:/MVS/TAPE/TNEWTAP.AWS
```

8.23.5 Sample Utility Output

Sample 1:

Copy the first 10 files from AWSTAPE file T38321A.AWS to T4352AA.AWS.

```
D:\HERCULES>tapesplt D:/MVS/TAPE/T38321A.AWS D:/MVS/TAPE/T4352AA.AWS 10
Hercules tape split program Version 3.05
(c)Copyright 1999-2005 by Roger Bowler, Jan Jaeger, and others
Writing output file D:/MVS/TAPE/T4352AA.AWS.
VOL138321A
HDR1DOCLIB            38321A00010001            00301400000000000000IBM OS/VS 370
HDR2V327523273600STP321VA/DOCLIB P S    68216
```

```

File 1: Blocks=3, block size min=80, max=80
File 2: Blocks=16, block size min=20, max=32740
EOF1DOCLIB          38321A00010001          00301400000000000016IBM OS/VS 370
EOF2V327523273600STP321VA/DOCLIB P  S   68216
File 3: Blocks=2, block size min=80, max=80
HDR1RIMLIB          38321A00010002          00301400000000000000IBM OS/VS 370
HDR2V327523273600STP321VA/RIMLIB P  S   68216
File 4: Blocks=2, block size min=80, max=80
File 5: Blocks=47, block size min=20, max=5140
EOF1RIMLIB          38321A00010002          00301400000000000047IBM OS/VS 370
EOF2V327523273600STP321VA/RIMLIB P  S   68216
File 6: Blocks=2, block size min=80, max=80
HDR1HOLDDATA        38321A00010003          00301400000000000000IBM OS/VS 370
HDR2F031200008000STP321VA/HOLDDATA P  B   68216
File 7: Blocks=2, block size min=80, max=80
File 8: Blocks=794, block size min=3040, max=3120
EOF1HOLDDATA        38321A00010003          003014000000000000794IBM OS/VS 370
EOF2F031200008000STP321VA/HOLDDATA P  B   68216
File 9: Blocks=2, block size min=80, max=80
HDR1PGMDIR          38321A00010004          00301400000000000000IBM OS/VS 370
HDR2V327521065600STP321VA/PGMDIR P  S   68216
File 10: Blocks=2, block size min=80, max=80

```

Figure 226: TAPESPLT utility output

8.24 DMAP2HRC (P/390 DEVMAP conversion program)

8.24.1 Function

The P/390 DEVMAP to Hercules conversion program reads an IBM P/390 device map file, extracts the device definitions, and writes these as a valid Hercules configuration file to the standard output.

8.24.2 Syntax

Descriptive

DMAP2HRC *filename*

Diagram

▶— DMAP2HRC — *filename* —▶

8.24.3 Parameter

filename The name of the DEVMAP input file containing P/390 device statements.

8.24.4 Examples

Example 1:

Convert the P/390 DEVMAP file DEVMAP.DVC to a Hercules configuration file named HERCULES.CNF.

```
D:/HERCULES/DMAP2HRC D:/S390/CONF/DEVMAP.DVC >D:/S390/CONF/HERCULES.CNF
```

8.24.5 Sample Utility Output

With the exception of error messages (if any) the utility does not produce any screen output.

8.25 PRTPUB (Mainframe print publishing program)

The mainframe print publishing program is written by Dan Nelson and can be obtained in the file section of the Hercules-390 discussion group (<http://groups.yahoo.com/group/hercules-390>).

8.25.1 Function

The mainframe print publishing program was designed to be used with Hercules' printing facilities. Hercules emulates line printers as simple text files containing printed output. This output can be viewed using a text editor or some other mechanism (such as being served via a web server).

This PRTPUB program converts the raw printer output to a more readable form by replacing formfeed characters with line break lines, converting newlines to CR/LF pairs if desired (for Windows viewing), and placing the result in a specified file.

Several facilities are provided to allow for publishing the printed output in an automated way (e.g. to a web server) as follows.

- 1) You can choose to publish the output only if the input file size has changed since the last time the program was run. The file size is stored in a file for comparison on each run and the program terminates with return code 4 if the input file size has not changed since the last run. This allows efficient mirroring of the printed output to a separate file on a schedule, only updating the target file if the source file has changed. There is also an option that permits the polling for change to be carried out in this program, thus saving the resources that would otherwise be used to launch the program, parse the options, and so forth on each iteration.
- 2) You can choose to publish only the last part of the printed output. Hercules printer files tend to grow and grow in size and users are typically only interested in the last part, printed most recently. An option lets you specify the number of lines at the end of the file to publish to the target file, or lets you publish only the new data since the last run.
- 3) Locking is provided under UNIX type operating systems. As a courtesy this program will acquire an advisory read lock on the entire file before it starts processing. If the emulator uses an advisory write lock then this program can be scheduled to publish the output asynchronously to the emulator producing that output and the result will always be consistent.
- 4) If you want to publish the output as a web page without using a mechanism like server side includes, this program provides the option of supplying HTML tags to wrap the output, although this facility is only rudimentary. For sophisticated formatting server side includes are likely more appropriate to pull data into a page but this facility may be useful for simple scenarios.

The program should be used in a batch file. It is possible to use it for a single call or to build a loop for continuous processing (see examples below).

The possible return codes and their meaning are:

- | | |
|----|---|
| 0 | Translation was done. |
| 4 | Translation was skipped because the file size did not change. |
| 8 | Processing failed for an ordinary reason. An error message is sent to stderr indicating why. |
| 16 | Processing failed due to some abnormality. An abend code is given for diagnostic purposes. This code will be the source line where the error occurred so you can use it with the source listing to diagnose the cause of the failure. |

8.25.2 Syntax

Descriptive

```
PRT PUB inputfile,outputfile [, [sizefile] , [interval] , [taillines]  
      , [CRLF] , [HTML] , [NOPB]]
```

Diagram

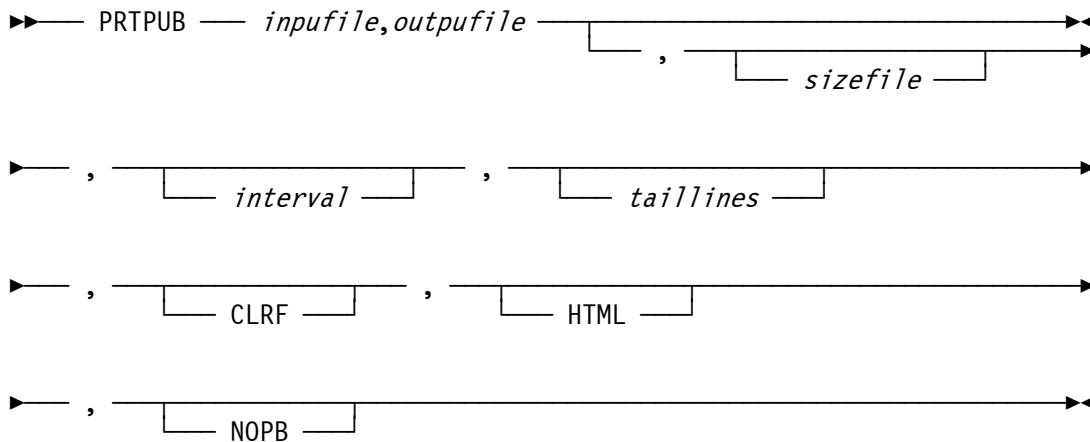

8.25.3 Parameter

The program takes a single long argument which must not contain spaces. If the file paths (on Windows) contain spaces then the entire argument must be enclosed in quotes. No spaces are allowed anywhere else, whether or not quotes are used. If quotes are used then they are only permitted as the first and last characters of the argument string.

The argument is divided into subparameters separated by commas. All parameters are positional, if they are omitted a comma must mark their place.

- | | |
|-------------------|---|
| inputfile | The file containing the emulated mainframe output. |
| outputfile | The file to which the result is to be published. |
| sizefile | The file containing the input file's size at the time of the previous run. If specified, this file is used to track the size of the input file, only publishing when it changes. The file will generally not exist the first time it is specified. In that case, the publishing is done and the file is written for use in subsequent runs. The file contains a number in binary form. It cannot be directly edited. If this parameter is not specified then the publishing is always done regardless of the file's size. |
| interval | The polling interval for use with the size file. If this argument is specified it must be a positive integer and it indicates a number of seconds between file size checks. In this mode if the input file's size has not changed since the last invocation (based on the size stored in the size file), the program goes into polling mode where it continually checks the size every interval seconds until a change is detected and then continues processing. If |

this argument is not given the default behavior is to return with a return code of 4 when the input file's size has not changed. Using this argument can improve the efficiency of simple polling in cases where nothing else is to be done on each polling interval. This is because it does not require the program to be invoked, arguments to be processed etc., on each polling interval. If no size file is specified this argument is checked for syntax but otherwise ignored.

- tailines** The number of lines that should be published. If the input file contains more than the given number of lines then only the last <tail lines> lines are published. If this parameter is not specified the entire file is published. This number gives the number of printed lines published, including page separators. Note that the number may be off by one in either direction. If the final character of the file is a formfeed then a trailing page separator is always output, which can add an extra line in some cases. By the same token if the tail is broken on a formfeed character then the entire formfeed, which counts as two line breaks, is skipped, resulting in one fewer line of output. If this argument is 'ONLY' (in all caps) then the size file must also be specified. In that case the program translates only the part of the printer file that is new since the prior invocation, unless the new size is smaller than the old size, in which case the whole file is translated. The purpose of this feature is to allow this program to be used as a sort of spool writer in conjunction with scripts that do something interesting with the incremental output, such as print it to a printer. In this mode empty output files are not produced. If the output is zero length and ONLY is specified, the program terminates with a return code of 4.
- CRLF** If specified then all linefeeds in the source file are translated to CR/LF pairs and CR/LF is used as the terminator for the page break line. If not specified no linefeed translation is done and the page break line is terminated with a newline character. This parameter is case sensitive (must be uppercase).
- HTML** If specified then HTML tags are added to the published output file. The file begins with <HTML><PRE> and ends with </PRE></HTML>. This parameter is case sensitive (must be uppercase).
- NOPB** If specified then formfeed characters are not translated to page break lines. This is useful primarily for processing the published data after it is published, e.g. sending it to a real printer, etc. This argument must be in upper case. When NOPB is specified formfeed characters are still bracketed with newlines to keep the maximum output record size consistent.

8.25.4 Examples

Example 1:

Publish the print output from print file PRT1.TXT and create a Word document named PRT1.DOC with carriage return/line feeds and do not translate formfeed characters to page break lines.

```
D:\HERCUELS\PRTPUB D:\MVS\PRT\PRT1.TXT,D:\MVS\PRT\PRT1.DOC,,,CRLF,,NOPB
```

Example 2:

Publish the print output from print file PRT2.TXT and create a HTML document named PRT2.HTML with carriage return/line feeds.

```
D:\HERCULES\PRTPUB D:\MVS\PRT\PRT2.TXT,D:\MVS\PRT\PRT2.HTML,,,CRLF,HTML
```

Example 3:

Publish the print output from print file PRT00E.TXT and create a HTML file called PUBL.HTML with carriage return/line feeds. The input file's size at the time of the previous run should be kept in file PRT00E.SIZ. The polling interval to check the file size is 10 seconds. The maximum number of lines that should be published is 1000.

```
@echo off
:LOOP
prtpub prt00e.txt, publ.html, prt00e.siz, 10, 1000, CRLF, HTML
if errorlevel 1 goto NOTDONE
echo PRINT FILE UPDATED
goto LOOP
:NOTDONE
echo ERROR - NO UPDATE DONE
goto LOOP
```

8.25.5 Sample Utility Output

With the exception of error messages (if any) the utility does not produce any screen output.

8.26 AWSSL (AWS virtual tape)

AWSSL is written by Reed H. Petty and is available on the CBT MVS Utilities Tape (CBTTAPE) at www.cbttape.org (File #585).

8.26.1 Function

AWSSL moves MVS (OS390, etc) datasets directly to/from AWS (and HET) virtual tape files. AWSSL strives to maintain compatibility with other AWS/HET utilities including AWSUTIL, VTTS, HETUTL and the Hercules Emulator.

AWSSL creates AWS and HET format virtual tapes which contain one to many datasets of any record format, with or without standard labels. The program will also retrieve datasets from AWS/HET files of any record format with the exception of spanned blocks. The retrieved datasets may be reblocked if necessary. If DCB attributes are omitted on the receiving dataset and if standard labels are present within the AWS structure, then the DCB attributes of the receiving dataset will be defaulted to those within the HDR1 label.

8.26.2 Input Parameter

All input parameters are taken from control statements supplied by the AWSCNTL DD statement. The statements consist of a major function to be performed (i.e. TAPEVOL, EXPORT, etc.), and keywords which supply values to that function.

Control statement keywords may be continued to as many records as necessary. Continued statements are indicated by the last keyword argument suffixed with a comma and additional keywords on the next record. Additional keywords must not begin in column one.

8.26.3 AWSVOL Control Statement

The AWSVOL control statement supplies characteristics of the virtual tape volume including volume serial number, owner and compression. AWSVOL must be the first control statement specified.

Descriptive

```
AWSVOL VOLSER=volser [,OWNER=owner] [,COMPRESS={0 | 1 | 2}] [,LEVEL={1 | n}]
```

Diagram

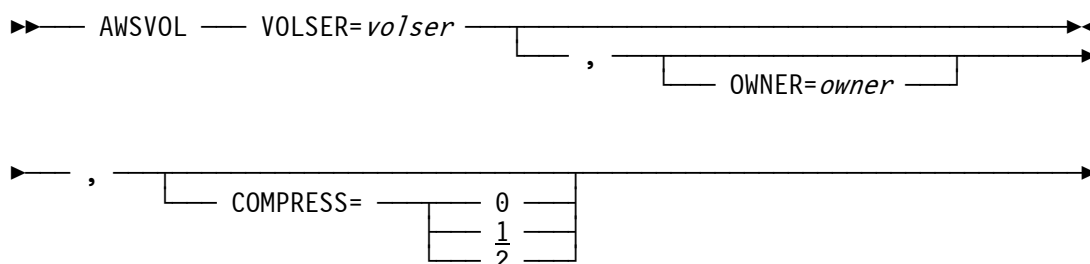

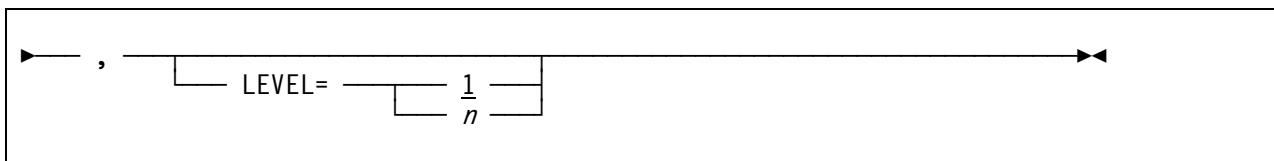

- VOLSER=volser** This specifies the volume serial number, volser is a 1 to 6 byte argument.
- OWNER=owner** The given *owner* will be included into the VOL1 owner field, owner is a 1 to 10 byte argument.
- COMPRESS=n** Compression, 0 = no compression, 1 = zlib, 2 = bzip. If COMPRESS=0 is coded then an AWS format is assumed. Default is HET format with COMPRESS=1 (zlib).
- LEVEL=n** Specifies the level of compression (0 – 9). Default is LEVEL=1.

8.26.4 AWSGET Control Statement

The AWSGET control statement will supply values that are necessary to retrieve a dataset from an AWS or HET virtual tape volume. Decompression is invoked automatically when required.

Descriptive

AWSGET INDSN=*dsname*,OUTDD=*ddname* [,FILENO=*nnnnn*] [,SL={YES | NO}]

Diagram

The diagram shows the syntax for the AWSGET control statement. It starts with 'AWSGET' followed by 'INDSN=dsname', a comma, 'OUTDD=ddname', another comma, 'FILENO=nnnnn', a third comma, and 'SL={YES | NO}'. The entire statement is enclosed in a larger box with arrows at the ends.

- INDSN=dsname** This specifies the dataset name (up to 44 bytes) of a dataset stored inside of the AWS or HET virtual tape.
- OUTDD=ddname** This is the DDNAME representing the dataset to receive the data from the virtual tape.
- FILENO=nnnnn** Specifies the file number of the dataset inside of the AWS or HET virtual tape. This may be a standard label file number or an absolute file number depending on the value of the SL= keyword.
- SL=value** If the value is YES then standard label numbers are present, if the value is NO then the file numbers are absolute numbers. This keyword also impacts the meaning of the FILENO= keyword.

INDSN=dsname	Specifies the dsname to be dynamically allocated and placed into the AWS or HET virtual tape file.
OUTDSN=dsname	The dataset name (up to 44 bytes) to be placed into the labels which precede and follow the file on the virtual tape.
TAPEDSN=tapedsn	The datasetname (up to 17 bytes) to be placed in the label.
UNLOAD=value	Selects the utility (IEBCOPY or IDCAMS) to be called to stage the input dataset prior to insertion into the virtual tape.
TYPE=value	If UNLOAD=IDCAMS is selected then the TYPE value specifies the method (EXPORT or REPRO) to be used to stage the dataset prior to insertion into the virtual tape.

8.26.6 Samples

Sample 1:

Create an AWS virtual tape from several input datasets/input DDs:

```
//VIRTTAPE EXEC PGM=AWSSL
//STEPLIB DD DSN=your.loadlib,DISP=SHR
//AWSPRINT DD SYSOUT=*
//myddnam1 DD DSN=your.file1,DISP=SHR
//myddnam2 DD DSN=your.file2,DISP=SHR
//AWSFILE DD DSN=volser.aws,DISP=(NEW,CATLG,DELETE),
//          SPACE=(your_space_parms),
//          DCB=(your_DCB_parms)
//AWSCNTL DD *
AWSVOL VOLSER=mytape,COMPRESS=0
AWSPUT INDSN=your.first.dataset
AWSPUT INDSN=your.second.dataset,UNLOAD=IEBCOPY
AWSPUT INDD=myddnam1
AWSPUT INDD=myddnam1,UNLOAD=IEBCOPY
/*
```

Figure 227: AWSSL JCL (Create AWS virtual tape)

Sample 2:

Create datasets from files on an AWS virtual tape:

```
//VIRTTAPE EXEC PGM=AWSSL
//STEPLIB DD DSN=your.loadlib,DISP=SHR
//AWSPRINT DD SYSOUT=*
//myddnam1 DD DSN=my.file1,DISP=NEW,CATLG,DELETE),
//          SPACE=(your_space_parms),
//          DCB=(your_DCB_parms)
//myddnam2 DD DSN=my.file2, DISP=NEW,CATLG,DELETE),
//          SPACE=(your_space_parms),
//          DCB=(your_DCB_parms)
//AWSFILE DD DSN=volser.aws,DISP=SHR
//AWSCNTL DD *
AWSVOL VOLSER=mytape
AWSGET OUTDD=myddnam1,INDSN=your.dataset1,FILENO=1,SL=YES
AWSGET OUTDD=myddnam2,INDSN=your.dataset2,FILENO=5,SL=YES
/*
```

Figure 228: AWSSL JCL (Create datasets from AWS virtual tape)

8.27 AWSUTIL (AWS format tape file generation utility)

AWSUTIL is written by Brandon Hill and is available on the CBT MVS Utilities Tape (CBTTAPE) at www.cbttape.org (File #477).

8.27.1 Function

AWSUTIL is a comprehensive program for creating AWS format virtual tape files. The program can generate labels and write tape marks. Any dataset that can be accessed by BSAM can be copied to a virtual tape file. Any real tape device can have either a single file or the entire tape copied.

The commands for the utility are read from the SYSIN DD statement and status and errors are written to the SYSPRINT DD statement. The AWS tape image is written to SYSOUT as a VB file. This file is then suitable to be copied with FTP in binary mode to any other system.

Any number of DD statements representing sequential data and tapes can be specified and are read via the appropriate statement in SYSIN.

8.27.2 Control Statements

AWSUTIL supports these SYSIN control statements:

READ ddname	Perform BSAM read from <i>ddname</i> and convert each block to AWS tape format. This works on whatever BSAM will read. The maximum BLKSIZE is 32760.
GET ddname	Perform QSAM read from <i>ddname</i> and convert each block to AWS tape format. This works on whatever QBSAM will read. The maximum BLKSIZE is 32760.
TAPEFILE ddname	Perform EXCP read from a real tape device and convert each block to AWS TAPE format. Only works on a tape device. Maximum BLKSIZE is 65535. This command stops reading when a tape mark is read. Therefore only the current tape file is processed. If BLP were used only the tape headers would be processed.
TAPEALL ddname	Perform EXCP read from a real tape device and convert each block to AWS TAPE format. Only works on a tape device. Maximum BLKSIZE is 65535. This command rewinds the tape and reads until an error condition is returned. This effectively copies the entire contents of the tape. BLP is not necessary as a rewind command is sent before the tape is read. Tape marks are duplicated as they are encountered. <i>NOTE:</i> Because end of reel reflectors are rarely effective this command can run a tape off the reel on a 3420 type drive. 3480/3490/3590 type drives have better stopping mechanisms.
TAPEMARK	Write a tape mark to the output file. This is usually used to separate individual files on a tape. Two consecutive tape marks sometimes signals the end of the tape.
VERIFY	Print a message after each command verifying that the command was executed ok. This merely prints a message. It has no effect on the integrity of the data. Because SYSOUT should be directed to disk there should be no data integrity problems anyway.
ASCII	All subsequent labels generated are converted to ASCII before they are written. This only affects labels. All data is copied exactly as it is read no matter the setting of this command.

EBCDIC	All subsequent labels generated are not to be converted before they are written. The implication is that the data is still in EBCDIC format. This only affects labels. All data is copied exactly as it is read no matter the setting of this command.
VOL1	These commands write 80 byte labels to the tape image. The format of the labels is controlled by the ASCII and EBCDIC commands. Except for the first 4 bytes of each input line none of the data is checked to make sure it is a valid tape label. It is up to the user to provide correctly formatted labels as desired. Essentially the entire 80 byte input record is written to the AWS TAPE image as is (or converted to ASCII if this flag is set).
HDR1 - HDR2	See VOL1 above.
EOF1 - EOF2	See VOL1 above.
EOV1 - EOV2	See VOL1 above.
UHL1 - UHL8	See VOL1 above.
UTL1 - UTL8	See VOL1 above.

8.27.3 Examples

The following example reads the first dataset from DASD and a second one dataset from tape and writes them to an AWS format dataset.

```
//MAKETAPE EXEC PGM=AWSUTIL
//STEPLIB DD DISP=SHR,DSN=my.load.library
//SYSPRINT DD SYSOUT=*
//SYSOUT DD DISP=(,CATLG),SPACE=(TRK,(15,15)),DSN=my.dsname
//INDATA DD DISP=SHR,DSN=my.input.sequential.data
//INTAPE DD DISP=OLD,DSN=my.real.tape.file
//SYSIN DD *
READ INDATA
TAPEMARK
TAPEFILE INTAPE
TAPEMARK
/*
```

Figure 229: AWSUTIL utility JCL

8.28 RAWSTAPE (Reverse AWSTAPE utility)

The RAWSTAPE program is written by Jan Jaeger and is available on the CBT MVS Utilities Tape (CBTTAPE) at www.cbttape.org (File #478).

8.28.1 Function

The RAWSTAPE utility converts an AWSTAPE file back to a blocked OS dataset such that the original blocking is restored. As an AWSTAPE file does not contain DCB parameters this utility will not restore the original DCB parameters, these will have to be added manually with a utility such as IEBGENER.

Upload the AWSTAPE file to OS/390 or z/OS in binary format, do not use CR/LF or any other blocking feature when doing the file transfer. The file must be uploaded to a RECFM=U dataset, either preallocated or allocated using IND\$FILE. BLKSIZE=4096 is reasonable but any other blocksize will work also.

An AWS tape file can consist of more than 1 file and as such the filenumber of the tape must be specified. This filenumber is equal to the value used when reading a tape with bypass label processing (BLP). Thus, on a labeled tape file 1 will always be the VOL1 record.

Run RAWSTAPE with SYSUT1 pointing to AWS input file and SYSUT2 to the output file, for example copying a standalone dump tape.

8.28.2 Examples

The following example copies an AWS tape format dataset back to a blocked OS dataset:

```
//CONVERT EXEC PGM=RAWSTAPE , PARM=3
//STEPLIB DD DSN=IBMUSER.LOAD , DISP=SHR
//SYSUDUMP DD SYSOUT=*
//SYSUT1 DD DISP=SHR , DSN=IBMUSER.SADUMP.AWS
//SYSUT2 DD DSN=IBMUSER.SADUMP , DISP=(NEW,CATLG) ,
// UNIT=SYSALLDA , SPACE=(TRK,1200,RLSE)
```

Figure 230: RAWSTAPE utility JCL

After the previous example the IBMUSER.SADUMP contains the correct data but still has invalid DCB parameters in the DSCB, these can be corrected with IEBGENER as following:

```
//SETDCB EXEC PGM=IEBGENER
//SYSPRINT DD SYSOUT=*
//SYSIN DD DUMMY
//SYSUT1 DD DUMMY , DCB=(DSORG=PS,RECFM=FBS,LRECL=4160,BLKSIZE=29120)
//SYSUT2 DD DISP=MOD,DCB=(*.SYSUT1),DSN=IBMUSER.SADUMP
```

Figure 231: IEBGENER JCL for RAWSTAPE utility

8.29 VTTS (Virtual tape transportation system)

The programs presented in this section are part of the VTTS (Virtual tape transportation system) and are copyrighted and owned by Sam Golob, however the programs on CBTTAPE File #533 can be used freely. The CBT MVS Utilities Tape (CBTTAPE) can be found at www.cbttape.org.

File #533 of the CBT tape contains the following programs:

- VTT2DISK
- VTT2TAPE
- VTT2CNVU
- VTT2FK2T
- VTT2T2FK

8.29.1 Function

The VTT2TAPE program converts AWS-format tape files to real tapes, while the VTT2DISK program creates an AWS-format virtual tape file from a real tape. The VTT2CNVU program converts a VB-format AWS-format tape (such as the one produced by the AWSUTIL program) to FB-80 format on MVS so that VTT2TAPE can be used subsequently to convert the data to a real tape.

The VTT2T2FK program is similar to VTT2DISK except that a real tape is converted to a FAKETAPE (tm) format tape (see below). VTT2FK2T is similar to VTT2TAPE except that a FAKETAPE tape image, folded over on MVS into FB-80 format, is converted into a real tape. Unless otherwise mentioned AWS-format virtual tape files on an MVS system have been folded over into fixed blocked 80-byte record format. AWS-format files on other systems are just long strings of data.

The FAKETAPE file format is a published interface of Fundamental Software Inc. Fundamental Software reserves the right to change the format at any time. FAKETAPE and FLEX-ES are registered trademarks of Fundamental Software Inc.

The AWS Tape format is produced by IBM's P/390 and Hercules systems to create disk files which an MVS system reads and writes as if they were actual tapes. Another name for these disk files is "virtual tapes", as the MVS system looking at these files "thinks" that they really are tapes.

There are programs like AWSUTIL which can read real tapes and create virtual tapes from them. These virtual tapes can be loaded on a Hercules system somewhere and be read as a tape.

VTT2DISK performs this function also, by reading a real tape and producing an FB-80 folded AWS-format tape as an MVS disk file. While reading the tape the VTT2DISK program produces a lot of statistics about the tape. The advantage of the VTT2DISK program is that it can be run on mainframe-based MVS systems that cannot normally produce AWS-format virtual tapes.

Another issue is encountered when transferring data in the other direction. Suppose you have an MVS system that cannot read a tape in AWS format. Most MVS systems which are not P/390 or Hercules machines are in this position. For these you have to convert an AWS virtual tape disk file to some format that the MVS system can convert into a REAL tape. That is the purpose of the VTT2TAPE program.

8.29.2 Control Statements

The VTT2DISK program allows the following keywords via the SYSIN DD Statement:

CHUNKSIZE=nnnn	Specifies the chunksize. Any chunksize up to the limit of 65535 bytes is allowed. If not specified the default is 65535 bytes.
NEWVOL=volser	This keyword changes the VOLSER on VOL1 label to <i>volser</i> .
READ	The READ keyword produces a read only run, no AWSOUT is created.

IDRCOFF

This keyword turns off the "data is compressed" indicators in the tape labels.

8.29.3 Examples

Example 1:

Read a tape and write it to an AWS format file.

```
//*****  
//* VTT2DISK - COPY TAPE TO DISK (AWS TAPE FORMAT) *  
//*****  
//AWSWRITE EXEC PGM=VTT2DISK  
//STEPLIB DD DSN=your.loadlib,DISP=SHR  
//AWSOUT DD DSN=your.aws.file,DISP=(NEW,CATLG),  
// DCB=(RECFM=FB,LRECL=80,BLKSIZE=27920),  
// SPACE=(CYL,(750,750),RLSE)  
//TAPIN DD DISP=OLD,UNIT=3490,VOL=SER=xxxxxxx,  
// LABEL=(1,BLP,EXPDT=98000)  
//SYSPRINT DD SYSOUT=*  
//SYSFILES DD SYSOUT=*  
//SYSTRACE DD SYSOUT=*  
//SYSMOVED DD SYSOUT=*  
//SYSUDUMP DD SYSOUT=*
```

Figure 232: VTT2DISK utility JCL.

Example 2:

Read an AWS format file and write it to a tape.

```
//*****
//* VTT2TAPE - COPY DISK (AWS TAPE FORMAT) TO REAL TAPE *
//*****
//AWSREAD EXEC PGM=VTT2TAPE
//STEPLIB DD DSN=your.loadlib,DISP=SHR
//AWSIN DD DSN=your.aws.file,DISP=SHR
//TAPOUT DD DISP=OLD,UNIT=3490,VOL=SER=xxxxxxx,
// LABEL=(1,BLP,EXPDT=98000)
//SYSPRINT DD SYSOUT=*
//SYSFILES DD SYSOUT=*
//SYSTRACE DD SYSOUT=*
//SYSMOVED DD SYSOUT=*
//SYSUDUMP DD SYSOUT=*
```

Figure 233: VTT2TAPE utility JCL

Example 3:

Convert an AWSUTIL file (VB) to standard AWS format (FB).

```
//*****
//* VTT2CNVU - CONVERT AWSUTIL FILE (VB) TO STANDARD AWS FORMAT (FB) *
//*****
//AWSCNVT EXEC PGM=VTT2CNVU
//STEPLIB DD DSN=your.loadlib,DISP=SHR
//AWSVBIN DD DSN=your.vbaws.file,DISP=SHR
//AWSFBOUT DD DSN=your.fbaws.file,DISP=(NEW,CATLG),
// DCB=(RECFM=FB,LRECL=80,BLKSIZE=27920),
// SPACE=(CYL,(300,50),RLSE)
//SYSPRINT DD SYSOUT=*
//SYSFILES DD SYSOUT=*
//SYSTRACE DD SYSOUT=*
//SYSMOVED DD SYSOUT=*
//SYSUDUMP DD SYSOUT=*
```

Figure 234: VTT2CNVU utility JCL

9. Shared Device Support

9.1 Basics

Shared Device Support (see also "General Information" manual) allows multiple Hercules instances to share devices. The device will be local to one Hercules instance and remote to all other Hercules instances. The local instance is the server for that device and the remote instances are the clients. It is possible that each instance acts as both a client and a server. If a local instance declares a device as remote on another instance and on this remote instance the device is defined again as remote on a third instance, then the original instance will have to hop through this second instance to get to the real device.

It is not necessary to IPL an operating system on the device server. Any number of Hercules instances can act as a server in a "HERCPLEX".

When "SHRDPORT" is specified in the Hercules configuration the thread "shared_server" is started at the end of Hercules initialization. If Shared Device Support is requested on a device statement then the Hercules instances cannot initialize these devices until the server is started on each system. In this case the device trying to access a server gets the 'connecting' bit set on in the DEVBLK and the device still needs to initialize. After the shared server is started a thread is attached for each device that is connecting to complete the connection (the device init handler).

9.2 Caching

Cached records (i.e. CKD tracks or FBA blocks) are kept independently on both the client and server sides. Whenever the client issues a START request to initiate a channel program, the server will return a list of records to purge from the clients cache. These will have been updated by other clients since the last START request. If the list is too large the server will indicate that the client should purge all records for the device.

9.3 Compression

Data that would normally be transferred uncompressed between the client and the host can optionally be compressed by specifying the "COMP=n" keyword on the device configuration statement (see below) or on the attach command. The value n of the "COMP=n" keyword is the zlib compression parameter which must be a number between 1 and 9. A value closer to 1 means less compression but less processor time to perform the compression. A value closer to 9 means the data is compressed more but also more processor time is required to compress the data.

If the server is on localhost then you should not specify compression. Otherwise you are just stealing processor time from Hercules to facilitate compression/decompression. If the server is on a local network then a low value such as 1, 2 or 3 is recommended. There is a tradeoff curve, attempting to trade CPU cycles for network traffic to derive an optimal throughput.

If the devices on the server are compressed devices (i.e. CCKD or CFBA) then the records (track images or block groups) may be transferred compressed regardless of the "COMP=n" settings. This depends on whether the client supports the compression type (zlib or bzip2) of the record on the server and whether the record is actually compressed in the server cache.

An example may help to explain this: Suppose on the client that you execute one or more channel programs to read a record on a CKD track, update a record on the same track, and then read another (or the same) record on the track. For the first read the server will read the track image and pass it to the client as it was originally compressed in the file. To update a portion of the track image the server must uncompress the track image so data in it can be updated. When the client next reads from the track image the track image is uncompressed.

Specifying "COMP=n" means that uncompressed data sent to the client will be compressed. If the data to be sent to the client is already compressed then the data is sent as is unless the client has indicated that it does not support that compression algorithm.

9.4 Usage of Shared Devices

To use a device on a remote Hercules instance, instead of specifying a file name on the device statement, an IP address or a DNS name is specified.

9.4.1 Syntax

Descriptive

```
loc_devnum devtype host[:port] [:rem_devnum] [COMP=n]
```

Diagram

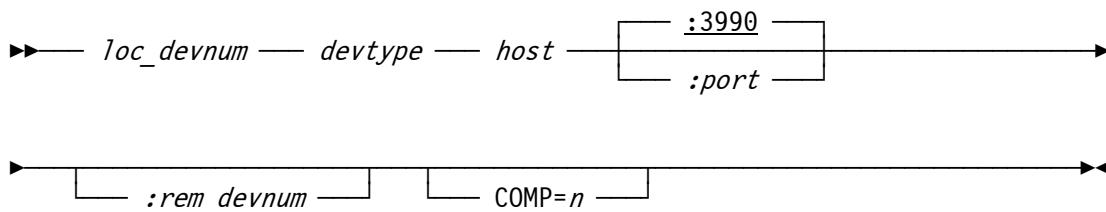

9.4.2 Parameter

- loc_devnum** This specifies the device address on the local Hercules instance.
- devtype** This is the device type.
- host** This specifies the host name or the IP address of the system where the Shared Device Server is running.
- port** The port number on which the Shared Device Server is listening. If the port number is omitted then the default port (3990) is used.
- rem_devnum** This is the device address of the device on the remote Hercules instance. If the remote device address is omitted then the default is the current device number on the local system.
- COMP=n** This keyword requests that the data has to be transferred compressed between the client and the server. The argument *n* specifies the compression level (1-9). A value closer to 1 means less compression but also less processor time to perform the compression. A value closer to 9 means the data is compressed more but also more processor time is required to compress the data.

9.4.3 Examples

Example 1:

There is a shared device server on the local host listening on port 3990 and we want to use its 0100 device as our 0100 device. The device statement will look like this:

```
0100 3390 localhost:3990:0100
```

Because the default port number is actually 3990 and the default remote device address is the same as the local device number the above statement (providing we do not have actually a file named 'localhost') could be shortened as follows:

```
0100 3390 localhost
```

Example 2:

Device sharing can also be split between multiple instances. For example, suppose the following device definitions and system parameter for instance A:

```
SHRDPORT 3990
0100 3390 localhost:3991
0101 3390 mvscat.dasd
```

And for instance B we have the following device definitions and system parameter:

```
SHRDPORT 3991
0100 3390 mvsres.dasd
0101 3390 localhost
```

In this case each instance acts as both a client and a server. Both instances of Hercules are running on the same machine.

The above examples may be clearer if we specify also all the default values. To show this the same configuration is used but in this case the Hercules instances are running on separate physical machines:

Hercules instance A (machine IP 192.168.200.1):

```
SHRDPORT 3990
0100 3390 192.168.200.2:3991:0100 # Remote on 192.168.200.2 (mvsres.dasd)
0101 3390 mvscat.dasd # Local on 192.168.200.1 (mvscat.dasd)
```

Hercules instance B (machine IP 192.168.200.2):

```
SHRDPORT 3991
0100 3390 mvsres.dasd # Local on 192.168.200.2 (mvsres.dasd)
0101 3390 192.168.200.1:3990:0101 # Remote on 192.168.200.1 (mvscat.dasd)
```

10. Hercules 3270 Logo

10.1 Function

The Hercules 3270 logo is the initial welcome screen that is presented when a 3270 terminal connects to a Hercules 3270 device. While in previous releases of Hercules this logo screen was hardcoded it can now be customized.

The customized logo is stored in a plain text file which contains positioning orders, attributes and supports variable substitutions. Each line in the text file represents either an order statement or a plain text line. If no logo file is specified then Hercules uses a built-in default logo. Upon startup Hercules will first look in the current directory for a file called "herclogo.txt". The name of the logo file can also be specified as a startup option by using the "-b" flag. The file may also be specified using the "LOGOFILE" configuration statement or can be changed during Hercules operation using the "HERCLOGO" console command.

10.2 Orders

Order commands are used to set the current buffer position, set the highlight and/or protected attributes, to force a skip to a new line and to specify text alignment.

10.2.1 Set Buffer Address

Descriptive

@SBA *x,y*

Diagram

▶ — @SBA — *x,y* —————▶

The Set Buffer Address order sets the current buffer position to row *x* and column *y*. Row and column both begin counting with zero.

10.2.2 Set Field

Descriptive

@SF {H | P | HP}

Diagram

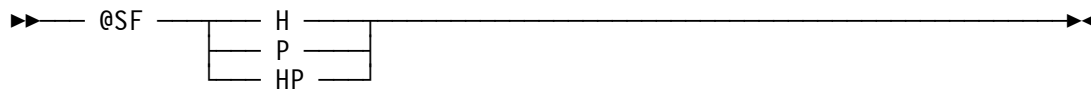

The Set Field order sets the highlight ("H") and/or protected ("P") attribute.

10.2.3 *New Line*

Descriptive

`@NL`

Diagram

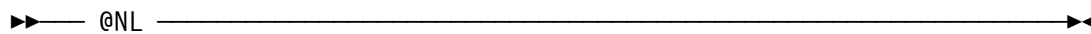

The New Line order forces a skip to a new line.

10.2.4 *Align*

Descriptive

`@ALIGN {NONE | LEFT | RIGHT | CENTER}`

Diagram

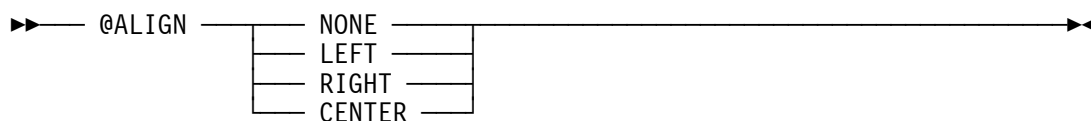

The Align order specifies the text alignment relative to the left and right borders of the terminal. When the alignment is other than "NONE" a new line is automatically inserted after each line of text. If the alignment is "NONE" then the text will be written without skipping to the next line.

10.3 Variables

It is possible to imbed substitution variables in the outgoing text. Substitution is indicated by enclosing the variable name between "\$(" and ")". The Hercules version as an example can be specified by the following string: \$(VERSION)

The following variables are defined. It is also possible to specify environment variable names.

- \$(VERSION)
The Hercules version.
- \$(HOSTNAME)
The host name, on which Hercules is running.
- \$(HOSTOS)
The host operating system.
- \$(HOSTOSREL)
The release of the host operating system.
- \$(HOSTOSVER)
The version of the host operating system.
- \$(HOSTARCH)
The host architecture.
- \$(HOSTNUMCPUS)
The number of host CPUs. UP (Uniprocessor for one CPU), or MP=n (Multiprocessor for more than one CPUs).
- \$(LPARNAME)
The LPAR name specified in the configuration file.
- \$(CSS)
The logical channel subsystem set or channel set for the terminal.
- \$(SUBCHAN)
The subchannel number for the terminal.
- \$(CCUU), \$(ccuu), \$(CUU), \$(cuu)
Various forms of the device number of the terminal.

10.4 Sample

The file "herclogo.txt" is provided in the Hercules distribution as a sample template. This sample reflects the contents of the built-in logo.

```
@ALIGN NONE
@SBA 0,0
@SF P
Hercules Version  :
@SF HP
$(VERSION)
@NL
@SF P
Host name       :
```



```

@SF HP
$(HOSTNAME)
@NL
@SF P
Host OS          :
@SF HP
$(HOSTOS)-$(HOSTOSREL) $(HOSTOSVER)
@NL
@SF P
Host Architecture :
@SF HP
$(HOSTARCH)
@NL
@SF P
Processors       :
@SF HP
$(HOSTNUMCPUS)
@NL
@SF P
Chanl Subsys     :
@SF HP
$(CSS)
@NL
@SF P
Device number    :
@SF HP
$(CCUU)
@NL
@SF P
Subchannel       :
@SF HP
$(SUBCHAN)
@SF P
@ALIGN LEFT

      HHH          HHH  The S/370, ESA/390 and z/Architecture
      HHH          HHH                      Emulator
      HHH          HHH
      HHH          HHH  EEEE RRR   CCC U  U L   EEEE SSS
      HHHHHHHHHHHHHHHHHHHHHH  E   R  R C   U  U L   E   S
      HHHHHHHHHHHHHHHHHHHHHH  EEE  RRR  C   U  U L   EEE  SS
      HHHHHHHHHHHHHHHHHHHHHH  E   R  R C   U  U L   E     S
      HHH          HHH  EEEE R  R  CCC  UU  LLLL EEEE SSS
      HHH          HHH
      HHH          HHH
      HHH          HHH      I can't believe it's not a MAINFRAME

      Copyright (c) 1999-2010 Roger Bowler, Jan Jaeger, and others

```

Figure 235: Logo File

This above sample file results in the following Hercules Logo screen:

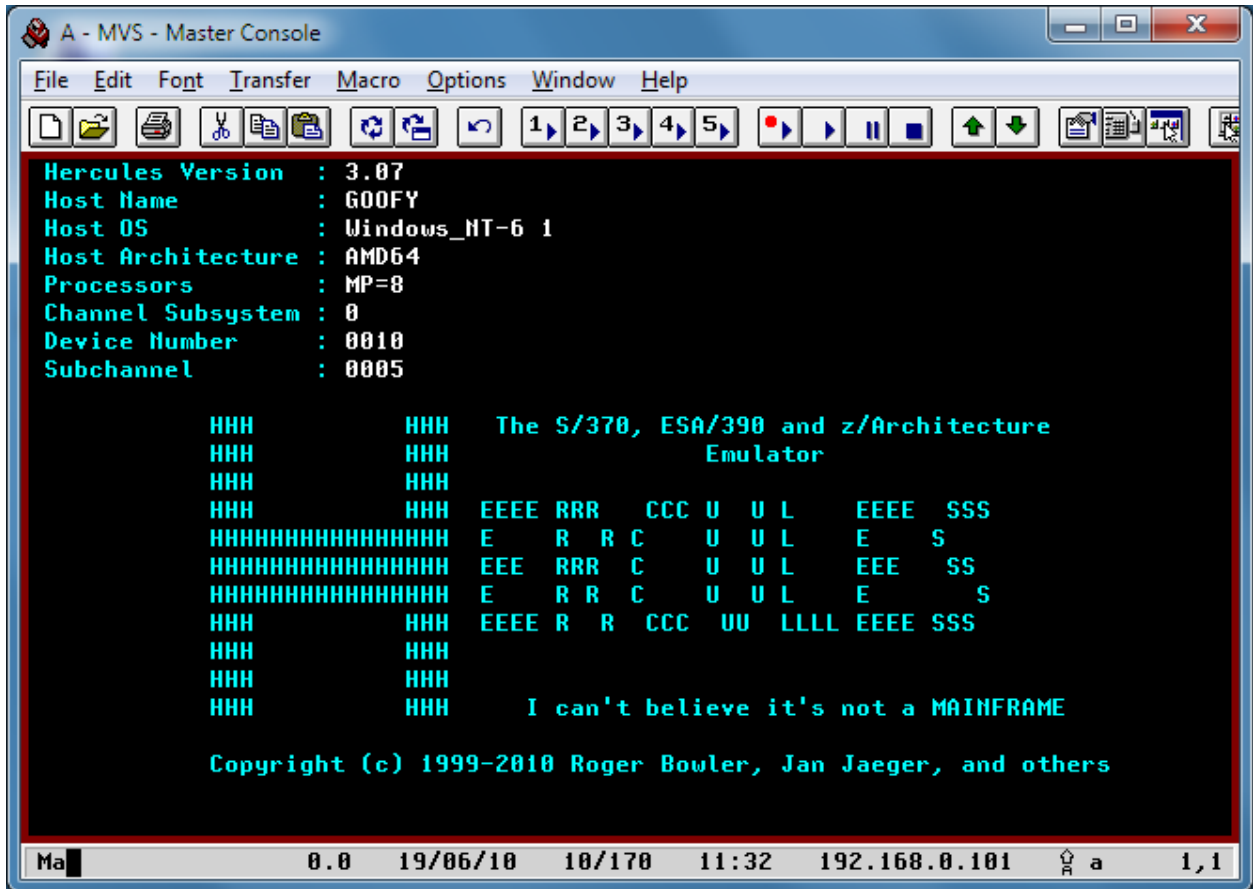

Figure 236: Logo Screen

11. Starting the Hercules Emulator

11.1 Starting Hercules in Native Mode

Hercules can be manually started from a Windows Command Prompt or can be started by calling a batch file (the preferred way). In both cases the syntax is the same.

11.1.1 Syntax

Descriptive

```
HERCULES [-f configfile] [-d] [-b logfile] [-p dyndir] [[-l dynmod] ... ]  
        [>logfile]
```

Diagram

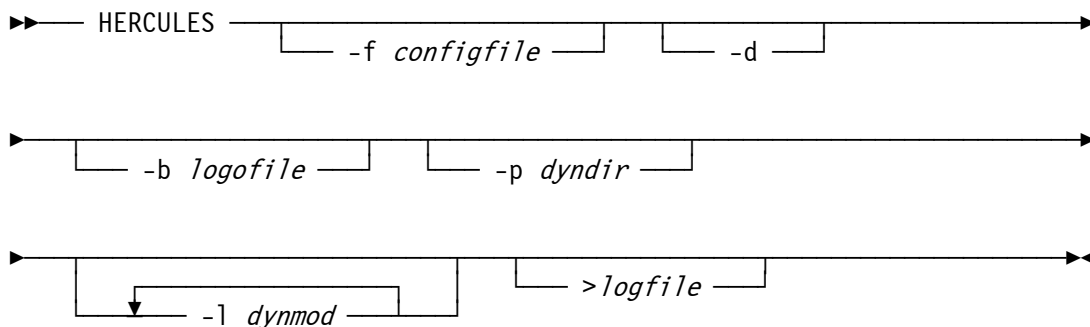

11.1.2 Parameter

- f configfile** This is the name of the configuration file. If the filename is not specified the default is HERCULES.CNF. The name of the default configuration file may be overridden via the 'HERCULES_CNF' environment variable.
- d** Specifies that Hercules is to be run in “daemon” mode, wherein it runs invisibly with no attached console.
- b logfile** Specifies the name of a customized logo text file in the current Hercules directory (for details on how to customize a logfile see chapter 10).
- p dyndir** This is the directory from which dynamic modules are to be loaded. The default depends on the host platform on which Hercules is being run. This option overrides the default.
- l dynmod** This is the name of an additional dynamic load module to be loaded at startup. More than one additional module may be specified, although each must be preceded with the “-l” option.

>logfile This is an optional log file which will receive a copy of all messages displayed on the control panel.

11.1.3 Examples

Example 1:

Start Hercules with the configuration file "D:\MVS\CONF\MVS38J.CONF" and write all messages to the log file "D:\MVS\LOGS\HERCULES.LOG".

```
HERCULES -f D:\MVS\CONF\MVS38J.CONF >D:\MVS\LOGS\HERCULES.LOG
```

Example 2:

Start Hercules with the configuration file "D:\S390\CONF\zLINUX.CNF" and with a logfile called "zLINUX_Logo.txt".

```
HERCULES -f D:\S390\CONF\zLINUX.CNF -b zLINUX_Logo.txt
```

11.2 Starting Hercules with the Windows GUI

The Windows GUI can be started by just clicking on the GUI icon. Then all necessary settings required to start Hercules can be specified using the GUI itself.

Alternatively the Windows GUI may also be manually started from a Windows Command Prompt or can be started by calling a batch file (which is the preferred way of these two options). In both cases the syntax is the same.

11.2.1 Syntax

Descriptive

```
HERCGUI [-f configfile]
```

Diagram

```
▶— HERCGUI —————▶  
      |  
      |— -f configfile —|
```

11.2.2 Parameter

-f configfile This is the name of a configuration file. If the HercGUI is started with the name of a configuration file then the HercGUI will automatically "power on" Hercules once the HercGUI itself is started. This is called the "Auto-Power-On" feature. When using this feature in conjunction with a Hercules ".RC" (run commands) file it is possible to totally automate Hercules startup and IPL.

11.2.3 Examples

Example 1:

Start Hercules using the HercGUI with the “Auto-Power-On” feature using the configuration file “D:\MVS\CONF\MVS38J.CONF”.

```
HERCGUI -f D:\MVS\CONF\MVS38J.CONF
```

Example 2:

Start the HercGUI without a configuration file.

```
HERCGUI
```

11.3 Starting Hercules with the Hercules Studio

The Hercules Studio can be started by navigating to the 'Applications -> System Tools -> Hercules Studio' menu entry and selecting it from there. Then all necessary settings required to start Hercules can be specified using the Hercules Studio itself.

Alternatively the Hercules Studio may also be manually started from a command shell or can be started by calling a script file. In both cases the syntax is the same.

11.3.1 Syntax

Descriptive

```
HerculesStudio [-f configfile] [-r rcfile]
```

Diagram

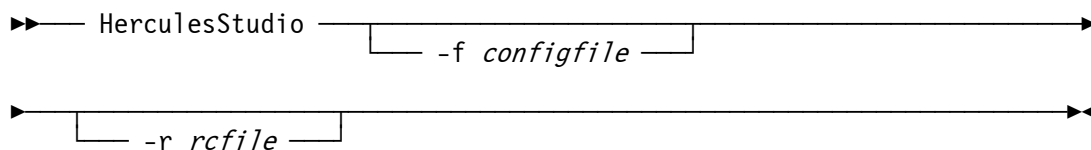

11.3.2 Parameter

-f configfile This is the name of a configuration file. If the Hercules Studio is started with the name of a configuration file then it will automatically “power on” Hercules once the Hercules Studio itself is started. This is called the “Auto-Power-On” feature. When using this feature in conjunction with a Hercules “.RC” (run-commands) file it is possible to totally automate Hercules startup and IPL.

-f rcfile This is the name of an optional RC (run-commands) file. This file contains Hercules console commands that are issued exactly as if the commands were entered from the Hercules system console.

11.3.3 Examples

Example 1:

Start Hercules Studio using the configuration file "mvs38j.cnf" and the run-commands file "autoipl.rc".

```
HerculesStudio -f mvs38j.cnf -r autoipl.rc
```

11.4 The hercules.rc (run-commands) file

Hercules supports the ability to have console commands automatically executed at startup via the 'run-commands' file. If the run-commands file is found to exist when Hercules starts then each line of the file is read and interpreted as a console command, exactly as if the command were entered from the HMC system console.

The default filename for the run-commands file is "hercules.rc", but may be overridden by setting the "HERCULES_RC" environment variable.

Except for the 'pause' command (see below), each command read from the run-commands file is logged to the console preceded by a '>' (greater-than sign) character. Thus you can easily distinguish between console commands entered from the keyboard from those entered via the .rc file.

Lines starting with '#' are treated as "silent comments" and are thus not logged to the console. Lines starting with '*' are treated as "loud comments" and *will* be logged.

In addition to being able to execute any valid console command (including the 'sh' shell command) via the run-commands file, an additional 'pause *nnn*' command is supported in order to introduce a brief delay before reading and processing the next line in the file. The value *nnn* can be any number from 1 to 999 and specifies the number of seconds to delay before reading the next line. Creative use of the run-commands file can completely automate Hercules startup.

12. Submitting Jobs via the Socket Reader

12.1 Socket Reader Basics

The “sockdev” option allows you to submit cards directly to a Hercules card reader from outside of Hercules. The card reader must be defined with the “sockdev” keyword and either a TCP/IP port number or the name of a Unix Domain Socket. Then whenever you want to submit a card deck to that particular card reader, you use an external program to connect to the socket and transmit the cards to the reader. Socket readers were implemented by Fish, based upon code originally contributed by Malcolm Beattie.

Socket readers are defined in the Hercules configuration like this:

Descriptive

```
devnum devtype sockspec sockdev [option [option ... ]]
```

Diagram

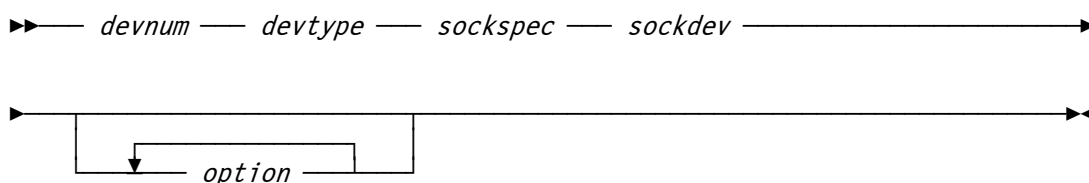

The socket specification *sockspec* can take any of the following formats:

- | | |
|--------------------------|--|
| ipaddr:port | The reader listens on the specific IP address and port number. <i>ipaddr</i> must be the IP address of an interface on the local system. For example, “127.0.0.1:1234” is used to accept only jobs submitted locally via the loopback interface. |
| hostname:port | Similar to the previous example, where <i>hostname</i> must resolve to an IP address belonging to the local system. Example: “localhost:1234”. |
| port | The reader listens on the specified port number and accepts jobs submitted from any IP address defined on the local system. Example: “1234”. |
| sockpath/sockname | The reader listens on the specified Unix Domain Socket. Example: “/tmp/hercrdr.00C” |

Examples:

```
000A  2501  127.0.0.1:2501 SOCKDEV ASCII TRUNC EOF
000C  3505  localhost:1234 SOCKDEV ASCII TRUNC EOF
0012  3505  3505 SOCKDEV ASCII TRUNC EOF
0014  2501  /tmp/hercrdr.014 SOCKDEV ASCII TRUNC EOF
```

12.2 Submitting Jobs from Windows

The “HercRdr” program is distributed as part of Fish’s GUI package and allows you to send jobs to a socket reader via TCP/IP. Simply enter “HercRdr” from the command line (i.e. from a “Command Prompt” window if you are using Windows NT / 2K / XP) to submit your file(s).

The following screen print shows the help information from the HercRdr program that is displayed whenever the program is called without parameters:

```
D:\HERCULES>hercrdr
Submits card file(s) to a Hercules card reader bound to a given socket:port.

Format:

  HERCRDR [-nnn] [host:port] file [file...]

Where:

  -nnn      timeout value in seconds (1-999; default is 3)
  host:port sock_spec of target reader (if not specified,
            value of HERCRDR environ var is used, if set)
  file      file(s) to be submitted

Examples:

  HERCRDR localhost:1234 fileone.txt filetwo.txt
  set HERCRDR=localhost:1234
  HERCRDR file3.txt file4.txt
  HERCRDR override:5678 filefive.txt
  HERCRDR 192.168.0.1:5678 666.txt 777.txt 888.txt 999.txt

Returns:

  -1  unclassified error
   0  file(s) successfully submitted
   1  no route to host (bad sock_spec or connection refused)
   2  timeout value exceeded while trying to connect
   3  transmission error (e.g. connection prematurely closed)
   4  file not found (or other file error)
```

Figure 237: HercRdr Help Screen

12.2.1 How to submit jobs directly from SPF/PC

If you are lucky enough to have a copy of the excellent editor SPF/PC Version4 or SPF/Pro (produced by CTC but unfortunately no longer available), then you can submit jobs directly from your edit session. The SUB command can be implemented by means of a REXX macro such as the following one, provided by Volker Bandke:

```

/* +----- REXX -----+ */
/*                                                                    */
/*      Name: D:\APPS\SPFPRO\REXX\USER\SUB.SPF                        */
/*                                                                    */
/*      Type: SPF edit macro                                         */
/*                                                                    */
/*      Desc: submit JCL to MVS 3.8                                  */
/*                                                                    */
/*      Creation date: 24 Aug 1999, creation time: 18:49:40         */
/*                                                                    */
/*      Author: (c) Volker Bandke                                    */
/*                                                                    */
/* +-----+ */
'isredit macro (p1 p2 p3 p4 p5 p6 p7 p8 p9) '
"ISREDIT (member) = MEMBER"
"ISPEXEC CONTROL ERRORS CANCEL"
parse upper var member file '.' ext
do
'ISREDIT REPLACE' $$$$$$.SPF '.ZF .ZL'
ADDRESS "CMD" "HERCRDR 192.168.1.102:3505 $$$$$$.SPF"
zedsmg = 'File submitted'
zedlmsg = 'The member '||member||' has been submitted to MVS'
'ispexec setmsg msg(isrz000)'
ADDRESS "CMD" "DELETE $$$$$$.SPF"
end
EXIT 0

```

Figure 238: SUBmit REXX for SPF/PC

12.3 Submitting Jobs from Unix

Submitting jobs from Unix can be done in two different ways, described in detail in the next sections:

- Using a Perl script
- Using the netcat program

12.3.1 Using a Perl script

Malcolm Beattie has provided a simple Perl script which can submit jobs using either TCP/IP or Unix Domain Sockets. The script is invoked using one of the following command formats:

```

hercsub 192.168.1.102:3505 dummy.jcl
hercsub /tmp/hercrdr.00C dummy.jcl

```

Here is the Hercsub script:

```
===== hercsub =====
#!/usr/bin/perl
use Socket;
use IO::Socket::UNIX;
use IO::Socket::INET;

if (@ARGV < 1) {
    print STDERR "Usage: hercsub socket_spec [job]\n";
    exit 2;
}

my $spec = shift @ARGV;
my $sock;

if ($spec =~ m{^/}) {
    $sock = IO::Socket::UNIX->new(Peer => $spec);
} else {
    $sock = IO::Socket::INET->new(PeerAddr => $spec);
}

die "Failed to connect to socket $spec: $!\n" unless defined($sock);

while (<>) {
    print $sock $_;
}
===== end of hercsub =====
```

Figure 239: The Hercsub Perl Script

12.3.2 Using the netcat program

The netcat (nc) program can also be used to submit files to a Hercules reader via TCP/IP. Install netcat (which is useful for many other things as well) and use the following syntax:

```
nc -w1 localhost 1234 < dummy.jcl
```

For more information on the netcat program, type *man nc* from the Unix shell.

Appendix A: Supported DASD Device Types

The following tables show the supported DASD device types and models with their sizes. The symbol “[*]” in the size column means that any size can be specified, else the size defaults to the first listed model.

CKD Devices

Devicetype-Model	Cylinders	Alternate Cylinders
IBM 2311	[*]	
IBM 2311-1	200	2
IBM 2314	[*]	
IBM 2314	200	3
IBM 3330	[*]	
IBM 3330-1	404	7
IBM 3330-2	808	7
IBM 3330-11	808	7
IBM 3340	[*]	
IBM 3340-1	348	1
IBM 3340-35	348	1
IBM 3340-2	696	2
IBM 3340-70	696	2
IBM 3350	[*]	
IBM 3350-1	555	5
IBM 3375	[*]	
IBM 3375-1	959	1
IBM 3380	[*]	
IBM 3380-1	885	1
IBM 3380-A	885	1
IBM 3380-B	885	1

Devicetype-Model	Cylinders	Alternate Cylinders
IBM 3380-D	885	1
IBM 3380-J	885	1
IBM 3380-2	1770	2
IBM 3380-E	1770	2
IBM 3380-3	2665	3
IBM 3380-K	2665	3
EMC 3380 K+	3339	3
EMC 3380 K++	3993	3
IBM 3390	[*]	1
IBM 3390-1	1113	1
IBM 3390-2	2226	2
IBM 3390-3	3339	1
IBM 3390-9	10017	3
IBM 3390-27	32760	3
IBM 3390-54	65520	3
IBM 9345	[*]	
IBM 9345-1	1440	0
IBM 9345-2	2156	0

Table 20: Supported CKD DASD Devices

FBA Devices

Devicetype-Model	Blocks
IBM 3310	[*]
IBM 3310-1	125664
IBM 3370	[*]
IBM 3370-A1	558000
IBM 3370-B1	558000
IBM 3370-A2	712752
IBM 3370-B2	712752
IBM 9313	[*]
IBM 9313-1	246240
IBM 9332	[*]
IBM 9332-200	360036
IBM 9332-400	360036
IBM 9336-600	554800
IBM 9335	[*]
IBM 9335-1	804714
IBM 9336	[*]
IBM 9336-10	920115
IBM 9336-20	1672881
IBM 9336-25	1672881
IBM 0671-08	513072
IBM 0671	574560
IBM 0671-04	624456

Table 21: Supported FBA DASD Devices

Appendix B. Syntax

This book uses two kinds of describing the syntax of configuration statements, console commands and utilities. These are:

- Syntax descriptions
- Syntax diagrams

B.1 Reading Syntax Descriptions

All syntax descriptions in this book (configuration statements, console commands and utilities) use a common structure as described in the following table.



KEYWORDS	Keywords are denoted with upper case letters. Obey the spelling. In the actual statements or commands they can be coded in upper case or lower case letters.
<i>variables</i>	All user defined values are denoted with lower case italic letters. In the actual statements or commands they can be coded in upper case or lower case letters.
{ }	Signifies that all, or some portion, of the code elements between the braces are required elements. Note that the braces are not part of the statements and must be not coded.
[]	Signifies that all, or some portion of the code elements between the square brackets can optionally appear but are not required elements. Note that the square brackets are not part of the statements and must be not coded.
	The OR symbol signifies that you may use only one of the code elements or values from the possible choices. Note that the OR symbol is not part of the statements and must be not coded.
xxx,...	Signifies that there can be more than one value in a comma delimited list. Note that the dots are not part of the statements and must be not coded.
xxx ...	Signifies that there can be more than one value in a blank space delimited list. Note that the dots are not part of the statements and must be not coded.

Table 22: Reading Syntax Descriptions

B.2 Reading Syntax Diagrams

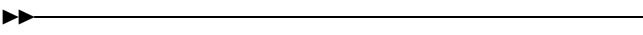
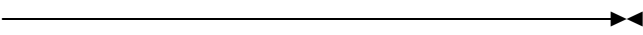
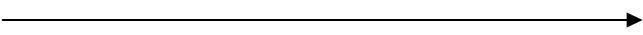
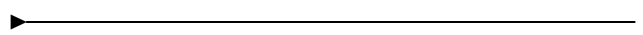
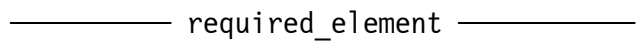
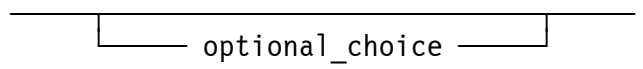
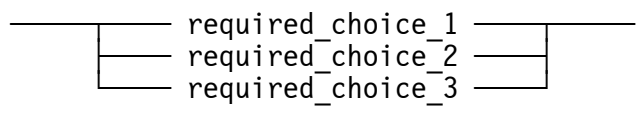
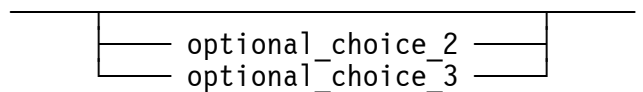
All syntax diagrams in this book (configuration statements, console commands and utilities) use a common structure as described in the following table.

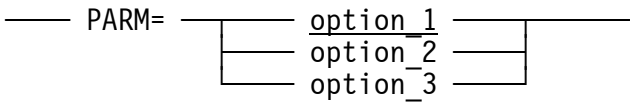
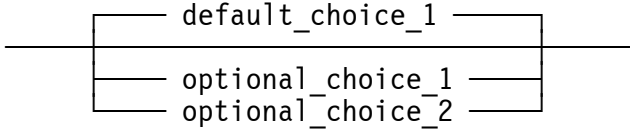
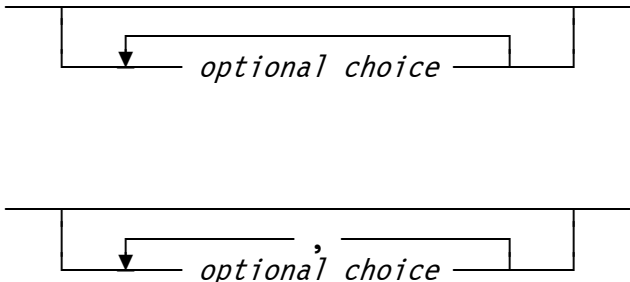
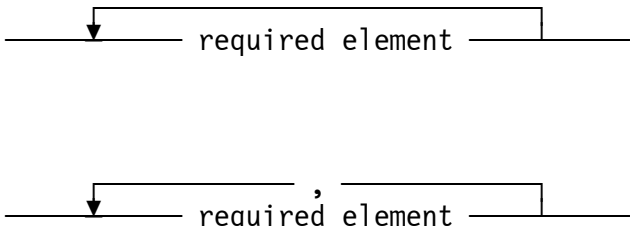
	<p>This symbol indicates the beginning of a statement.</p>
	<p>This symbol indicates the end of a statement.</p>
	<p>This symbol indicates that the statement is continued on the next line.</p>
	<p>This symbol indicates that the statement is a continuation from the previous line.</p>
	<p>A required element (keyword or variable) appears on the main path.</p>
	<p>An optional element (keyword or variable) appears below the main path.</p>
	<p>A required element (keyword or variable) with selection. Only one of the available options may be specified.</p>
	<p>Optional elements (keyword or variable) with selection are shown below the main line. Only one of the available options may be specified.</p>

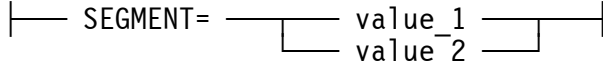
	<p>A keyword with options. Only one of the available options may be specified. The underscored option is the default if the whole keyword statement is not coded.</p>
	<p>Optional elements (keyword or variable) with selection are shown below the main line. If one element is the default, it appears above the main line. Only one of the available options may be specified. If none of these elements is explicitly specified, the default above the main line is taken.</p>
	<p>This is an optional, repeatable element. Specifying several elements is allowed. A character within the arrow path means that repeated items have to be separated by that character. Otherwise the items are separated by a blank.</p>
	<p>This is a required, repeatable element. Specifying several elements is allowed. A character within the arrow path means that repeated items have to be separated by that character. Otherwise the items are separated by a blank.</p>
	<p>Reference to a syntax segment, which is described separately.</p>
	<p>This symbol indicates a syntax segment which is referenced from the main syntax diagram.</p>

KEYWORDS	Keywords are denoted with upper case letters. Obey the spelling. Lower case letters are optional and can be omitted (for example DISable). In the actual statements or commands they can be coded in upper case or lower case letters.
<i>variables</i>	All user defined values are denoted with lower case italic letters. They represent user supplied names or values. In the actual statements or commands they can be coded in upper case or lower case letters.

Table 23: Reading Syntax Diagrams

Appendix C. Links

- **The Hercules System/370, ESA/390, and z/Architecture Emulator**

<http://www.hercules-390.org>

- **Hercules Developer Snapshots (Ivan Warren)**

<http://www.ivansoftware.com/snapshots/snapshots>

- **Hercules PDF Documentation (Peter Glanzmann)**

<http://hercdoc.glanzmann.org>

- **The MVS Tur(n)key System, Version 3 (Volker Bandke)**

<http://www.bsp-gmbh.com/turnkey/index.html>

<http://www.mvs-turnkey.de>

- **Hercules WinGUI (“Fish”, David B. Trout)**

<http://www.softdevlabs.com/Hercules/hercgui-index.html>

- **CTCI-W32 (“Fish”, David B. Trout)**

<http://www.softdevlabs.com/Hercules/ctci-w32-index.html>

- **Hercules Studio (Jacob Dekel)**

<http://www.mvsdasd.org/hercstudio>

- **WinPcap, Politecnico di Torino**

<http://www.winpcap.org>

- **Vista tn3270, Tom Brennan Software**
<http://www.tombrennansoftware.com>
- **X3270, Paul Mattes**
<http://x3270.bgp.nu>
- **AWSBROWSE (“Fish”, David B. Trout)**
<http://www.softdevlabs.com/Hercules/hercgui-index.html>
- **XMIT Manager**
www.cbttape.org
- **CBT MVS Utilities Tape (CBTTAPE)**
www.cbttape.org
- **Microsoft Visual C++ 2008 Express**
<http://www.microsoft.com/express/download/>
- **ZLIB**
<http://www.zlib.net>
<http://www.softdevlabs.com/Hercules/ZLIB1-1.2.3-bin-lib-inc-vc2008-x86-x64.zip>
- **BZIP2**
<http://www.bzip.org>
<http://www.softdevlabs.com/Hercules/BZIP2-1.0.5-bin-lib-inc-vc2008-x86-x64.zip>

- **PCRE**

<http://www.pcre.org>

<http://www.softdevlabs.com/Hercules/PCRE-6.4.1-bin-lib-inc-vc2008-x86-x64.zip>

Hercules Emulator

<p data-bbox="676 954 735 1346">Hercules System/370, ESA/390, z/Architecture Emulator</p> <p data-bbox="810 871 858 1424">User Reference Guide</p> <p data-bbox="930 1016 959 1283">Version 3 Release 07</p>
HEUR030700-02